

WORTHINGTON

DISTRIBUTION

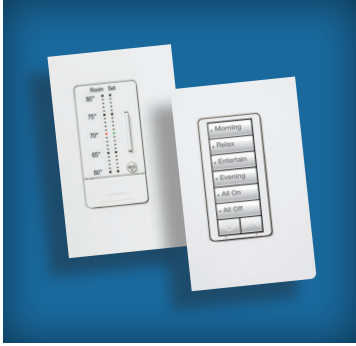

FALL 2013

WHOLESALE DEALER CATALOG



566 Route 390 • Tafton, PA 18464 • 800-282-8864



Security, energy management, and entertainment.

Comprehensive control systems for homes and small businesses, with no monthly fees.



Control security, view live surveillance cameras, unlock doors, and view event logs. Use a door station and included VoIP Intercom to see and speak with your guests. Control lights, temperatures, and A/V, too!



The revolutionary Hi-Fi 2 Four Zone, Four Source distributed audio system provides a powerful and sleek way to share your tunes.



MicroControl is a wireless energy management coordinator. Save money by automating your thermostat, water heater, pool pump, fountain, or table lamp!

Reliable. Powerful. Affordable.

COORDINATE DEVICES TO INCREASE SAFETY, REDUCE ENERGY EXPENSES, AND ENHANCE ENJOYMENT!

The OmniTouch 5.7e is HAI by Leviton's premier plug-and-play Touchscreen featuring customizable graphics and foreign language support. Monitor and control lights, small appliances, security, temperatures, pool and spa settings, ventilation, multi-room audio, surveillance video, and other essentials connected to an HAI by Leviton home automation system. The OmniTouch 5.7e is compatible with HAI by Leviton's OmniPro II, Omni IIe, Omni LTe, Lumina Pro, and Lumina controllers.

HAI by Leviton's powerful wireless ZigBee® products ensure energy savings in new construction and retrofit, controlling lights, lamps, fans, shades, pumps, and more with an optimum range of 200 feet. Use MicroControl™ as a standalone solution, or opt for the ZigBee® Interface Module if incorporating into an existing home control system. HAI by Leviton adheres to ZigBee® Pro and the Home Automation Profile.

The Hi-Fi 2 Four Zone, Four Source distributed audio system is built-in for a sleek look. Utilizing remote input modules, you can share any audio source with any room. Use the optional Bluetooth Remote Input module to stream from your tablet or smartphone! Or keep your iPhone docked and share your album art with all Touchscreens. The free iOS app even lets you control volume and audio sources from the pool patio. Need a larger system? The 8x8 version expands to 16 zones.



Control all A/V systems at once.

TOTAL A/V CONTROL WITH HAI BY LEVITON'S FREE APP AND HTX2 MOBILE DESIGN SOFTWARE.

Use the HTX2's custom graphic interface to control all audio and video equipment on an iPad or iPhone. A complete and beautifully stylish interface is included - or use the free HTX2 Mobile Designer software to completely customize your look. With HAI by Leviton, the options are only limited by your imagination. HAI by Leviton even provides free icons and templates for DVD/Blu-Ray, television, tuner, CD Changer and much more so that all your media devices are clearly represented and easily accessible. Take more control today with the HTX2 and the free iPhone/iPad apps.



Multiple HTX2's can be linked together to control dozens of AV components, perfect for residential media rooms or sports bars.



Control distributed audio and other sub-systems like lighting, security, or temperatures from an iPhone, iPod Touch, or iPad.



The HAI by Leviton Home Theater Extender2 (HTX2) lets you extend your home control to the audio/video equipment in your home theater.

**Whether for safety, energy management,
or entertainment, an HAI by Leviton security
& automation system has you covered!**

www.homeauto.com



iOS™, IR, WiFi, IP,
Relay, PoE, Serial,
Contact Closure,
Android™, iPad®.

Partners in Connectivity™



WiFi and IP enable IR, serial, and contact closure devices. Instantly.

Global Caché connectivity products are cost effective, easy to use, and easy to include in your automation and control environments using whichever popular control and automation software you choose, including iOS (iPad, iPhone, iPod Touch) and Android devices.



iTouch Flex IP and WiFi



iTouch Family of Products

iTouch Flex Features

- Access, monitor, automate, and control standalone equipment
- Web-based control protocol using HTTP
- 4 Megs flash memory - store web pages and files accessible via URL
- Tiny footprint
- 4 conductor Flex Link Port allows for versatility using Flex Link cables
- Built in IR learning and access commands to cloud-based IR database
- Mounting dock for simple installation
- Made in the USA and RoHS

Scan for more info:



Visit our website

www.globalcache.com

All trademarks are property of their respective owners.
©2012 Global Caché, Inc. All rights reserved.

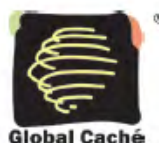



Program less. Make more.



Control Global Caché, HAI, Lutron, and Z-Wave via Leviton Vizia and Mi Casa Verde Vera controllers. Add thermostats, lighting, security, locks, and more to your customers' remotes!



With iRule, you can deliver powerful control to your customers at a significantly lower price point compared to other solutions. Offer your clients a custom remote that runs on their iOS or Android phone or tablet, and controls everything from a modest single-room entertainment setup to a whole-home automation system.

Even more exciting, you can deploy it in a customer's installation in minutes and manage it all remotely. Really!

iRule simply gives you the flexibility to add powerful control to any room – faster and easier than the competition.

iRule... Program less. Make more.



To learn more, contact your Worthington Distribution sales rep.
Visit us online at www.iRuleAtHome.com, or call us at 313-227-6136.

iRule... The simple, yet powerful control solution for the smart installer.



New Acclaim Thin Bezel Speakers.

Introducing the new look of Russound Acclaim Speakers. Big sound in a super sleek package, featuring magnetic grills and thin bezels to blend with any décor. Engineered for maximum acoustic performance and ease of in-ceiling or in-wall installation.

Get all the details at www.russound.com

Or call: 1.800.638.8055



audio everywhere

round or square grill options

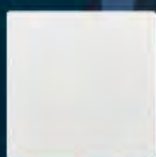

THIN BEZEL MAGNETIC GRILL AWESOME SOUND

Russound



Kwikset®

#1 Residential Lock Brand with Z-Wave



- ✓ **Increase RMR**
- ✓ **Increase system usage**
- ✓ **Provide the total security solution**
- ✓ **Increase customer retention**
- ✓ **Remain competitive in the security industry**



Now with lock support in Vizia RF + Installer

Home automation you can count on.



Make the switch to smarter living

Extra dividends are built into the Vizia RF +[®] collection. Our wireless home automation system saves time, effort and energy. The radio frequency products are easy to retrofit, quick to install and profitable as an upgrade. Your customers will love the one-touch control Vizia RF + gives them over their homes. You can bank on its reliability because it comes from Leviton, the smart choice for industry professionals.

For a closer look at Vizia RF +, visit leviton.com/viziarf

THE FUTURE IS ON[®]





Get Better Sound From Any TV ... And Your Smartphone

Maximize your TV and entertainment experience with the Proficient MaxTV, a one-piece stereo TV speaker that delivers high quality audio from TVs, smartphones and tablets. At only 4" high, MaxTV slips easily under a flat-panel TV.

Four channels of amplification power two down-firing 5¼" subs, four 2½" midranges and two 1" soft dome tweeters, delivering powerful bass, clear mids and dazzling highs — a feat no flat-panel TV or one-piece soundbar can match.

Featuring built-in Bluetooth® wireless technology, the MaxTV turns into a convenient music playback system. Simply connect via Bluetooth and stream music or internet radio from a smartphone, tablet or computer to listen through MaxTV.

Proficient MaxTV is the perfect sound solution for any TV in the home or office, delivering premium quality sound every time you turn it on. Plus, MaxTV gives you the flexibility of streaming music off your Bluetooth devices.

PROFICIENT
MaxTV™
TV Speaker with Bluetooth®

proficientaudio.com



INTELLIGENCE REPORT

NAME: WIRELESS TO WIRELESS TRANSLATOR™

ORGANIZATION: Resolution Products. Innovative security engineering making the products you need.

SKILLS: Translating existing wireless zones into compatible ones that your new panel can hear. Save both TIME and MONEY for you AND the customer.

MAIN TARGET: Security dealers, large and small, looking to take over existing wireless systems.

RESUME: Like an agent being handed their secret weapon, these enable dealers to work around the traditional takeover model. Avoid huge transmitter replacement costs with a solitary unit. Single-handedly changed the takeover market.

CAPABILITIES: Each unit can translate any wireless zone not being used for life safety or two-way devices.



COMPATIBLE WITH:

TRANSLATORS™	RECEIVING CONTROL PANEL				
	GE®	NAPCO®	HONEYWELL®	26IG®	DSC®
EXISTING SENSORS TO TRANSLATE	ELK M1XRFEG		ELK M1XRF2H		
GE®	RE120 (Repeater)	RE124GN	RE224GH RE234GH-L (inside Lynx)	RE224GT	RE324GD
NAPCO®	RE124NG	RE120N (Repeater)	RE224NH	RE224NH	RE324ND
HONEYWELL®	RE124HG	RE124HN	RE220 (Repeater)	RE220T (Repeater)	RE324HD
	RE134HG (inside SimonXT) RE134HG-A (SimonXT + GSM)				
DSC®	RE124DG	N/A	RE224DH	RE224DT	RE320 (Repeater)
26IG®	RE124TG	N/A	RE224TH	RE220T (Repeater-Exclusively through ResProd)	RE324TD



www.ResolutionProducts.com • 715.808.0164 • sales@resolutionproducts.com
1402 Heggen Street, Hudson, WI 54016

"GE", "Honeywell", and "DSC" are trademarks owned by General Electric Company, Honeywell International Inc., and Tyco Safety Products Canada LTD, respectively. Resolution Products, Inc. products will function with one of either GE, DSC or Honeywell systems. However, no Resolution product is produced by, endorsed by, nor is officially associated with GE, Honeywell or DSC. Resolution recommends verifying operation at installation. Do not use Translator for life safety devices, such as smoke or CO sensors.

HOW DO YOU FIT A BIG IDEA INTO A SMALL SPACE?

**SPECO TECHNOLOGIES
ALL-IN-ONE DVR!**





Patented

D4WRSPM

**DVR
POWER SUPPLY
MONITOR**

Remote
View on
iPhone®
or iPad®



FEATURE	DESCRIPTION
	Digital Deterrent™ Audio/Visual Crime Deterrent <i>Stop Crime Before It Happens.</i>
	EZ Wizards! → One click wizard guides you to set up essentials of the system in a logical and easy to understand sequence. EZ Copy, EZ Record, EZ Network
	Twitter Notifications DVR sends text message alerts of alarm events.
	8-Way Audio Communicate with remote locations in an instant to assist in crime prevention. (Available on CS platform)
	System Monitoring DVRs can report performance health issues via Twitter or Email.
	Remote Upgrade Single or multi-unit <u>remote</u> upgrade. Stay current with software updates without the cost of a service call.

Small footprint is perfect for installations with limited space

Every DVR is enclosed in a locked box

Deters employees from tampering with the DVR

Available in multiple operating platforms

Get
More
Info



speco technologies®

email: sales@specotech.com • ph: 1.800.645.5516 • specotech.com

iPhone & iPad are trademarks of Apple Inc., registered in the U.S. and other countries. Android is registered to Google.



CREATING THE RIGHT NETWORK FOR ANY HOME starts with the right products

Legrand's professional home networking solutions incorporate the latest technologies to ensure fast, reliable connections throughout any home. From wired to wireless, new construction to retrofit, we provide flexible, easy-to-install, whole-home solutions that create the best, most reliable networks for today's households.

» WWW.LEGRAND.US/DIGITAL-INFRASTRUCTURE



DA1054
4-Port Gigabit Router/Switch



DA2131-V1
Outdoor Wireless Access Point



DA2304-V1
4-Port Powerline Adapter



DA2204-V1
4-Port Coax Network Adapter



More Bass for Your Chaise

*Proficient All-Weather Speakers Deliver
The Big Backyard Bass Your Clients Crave*

No matter how comfortable the chaise lounge or how cool the drink, real relaxation comes only when the sound outdoors is as good as the sound indoors. That's why Proficient's all-weather speakers use a ported design — delivering deeper, more powerful bass.

The combination of the ported design with a big 8-inch woofer in our AW830 three-way brings outdoor sound to a new level. Even our compact AW525 pumps out enough bottom end to get any backyard grooving.

Proficient's all-weather line also includes twin-tweeter models for stereo sound from a single speaker, as well as stereo and twin-tweeter Rocks for stealthy sound. Our outdoor speakers sound great through years of rough weather because they're built tough.

They're everything you need to keep your clients happy tune after tune, summer after summer. All from Proficient — the residential installer's one-stop shop for incredible outdoor audio.



PROFICIENT

proficientaudio.com

Tools for today's Smart HomeOwner



Guard Dog.

Make sure your home is protected when you're away with dedicated wireless security and remote arming on command.



Remote Control.

The power to turn the lights on or off and adjust the thermostat is in the palm of your hand.



Spare Key.

Don't leave a key under a rock outside your house. Turn the deadbolt to lock or unlock the door with the touch of a button.



Home Movies.

Watch the live video feed from your home or see recorded clips of any motion or activity that happens while you're away.



Status Updates.

Get text updates and status alerts from your home while you're on the road to know what's going on back at the house.

Alarm.com products are readily available through Worthington Distribution.



ALARM.COM[®]

Your home in your hands.

For more information about becoming an Alarm.com Dealer visit:

www.alarm.com

© 2013 Alarm.com. All rights reserved.



simply more than security.

ONLY 2GIG COULD MAKE THE BEST EVEN BETTER.



Go!Control Security & Automation System

- game changing innovation
- interactive touch screen security
- smart home automation
- easy takeover of previous systems
- over-the-air software updates

Bienvenido, Bienvenu, and Bem-vindo.
We speak your language.

Indoor HD Camera

- crystal clear definition
- infrared night-vision
- always awake, continually capturing
- secure transmission whenever you need it

scan



follow us...



www.2GIG.com
866.670.1591

Introduce light and shade control today

under
\$110

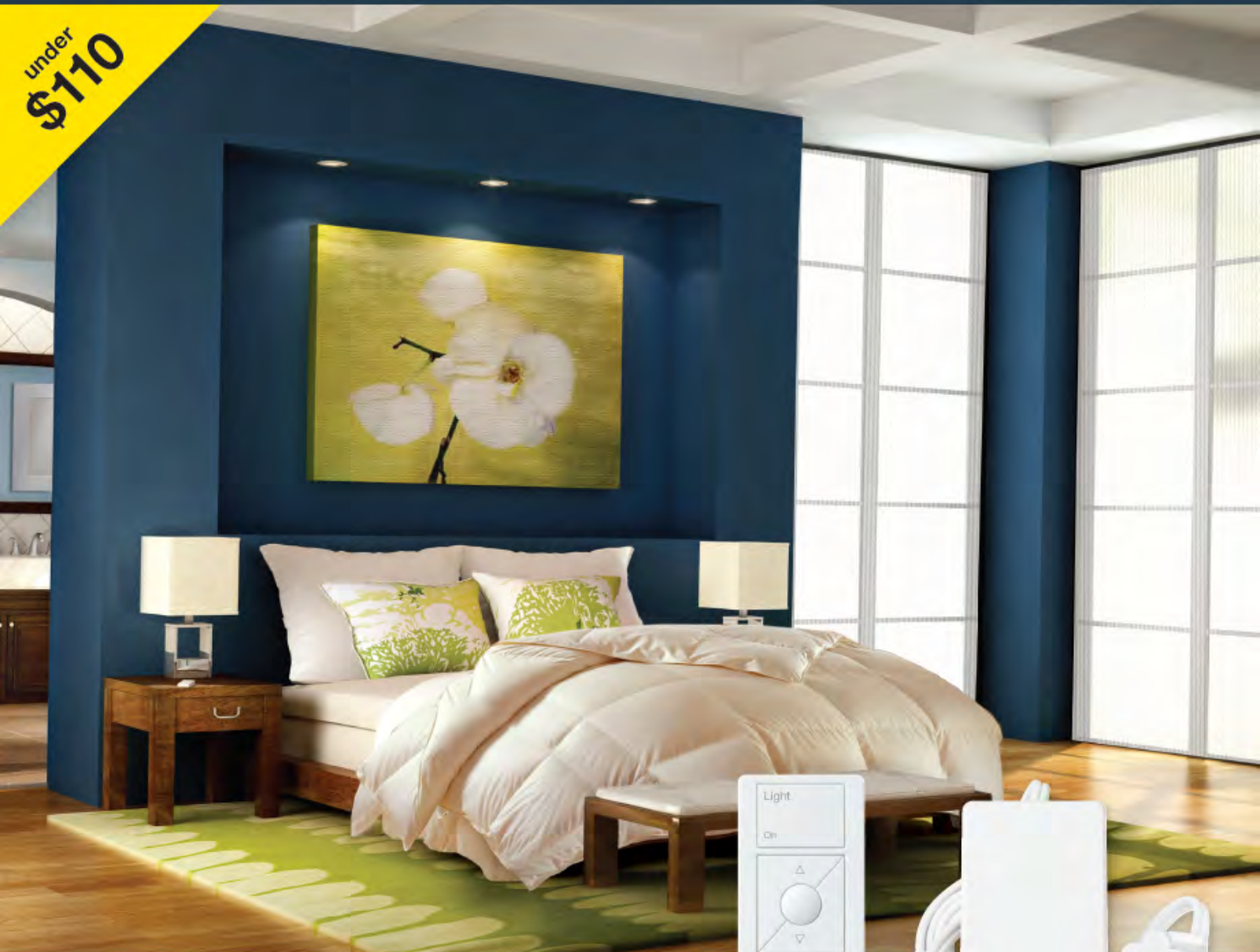

Every customer has a light or shade in their home that they would like to be able to control from another location.

And now they can.



Pico® wireless control

Plug-In dimming module

Lighting control solutions for **under \$110.**

Find light control solutions on page 21.



Contact Worthington for more information 1.800.282.8864
©2013 Lutron Electronics Co., Inc. P/N 306-0021 REV A

starting
at
\$285

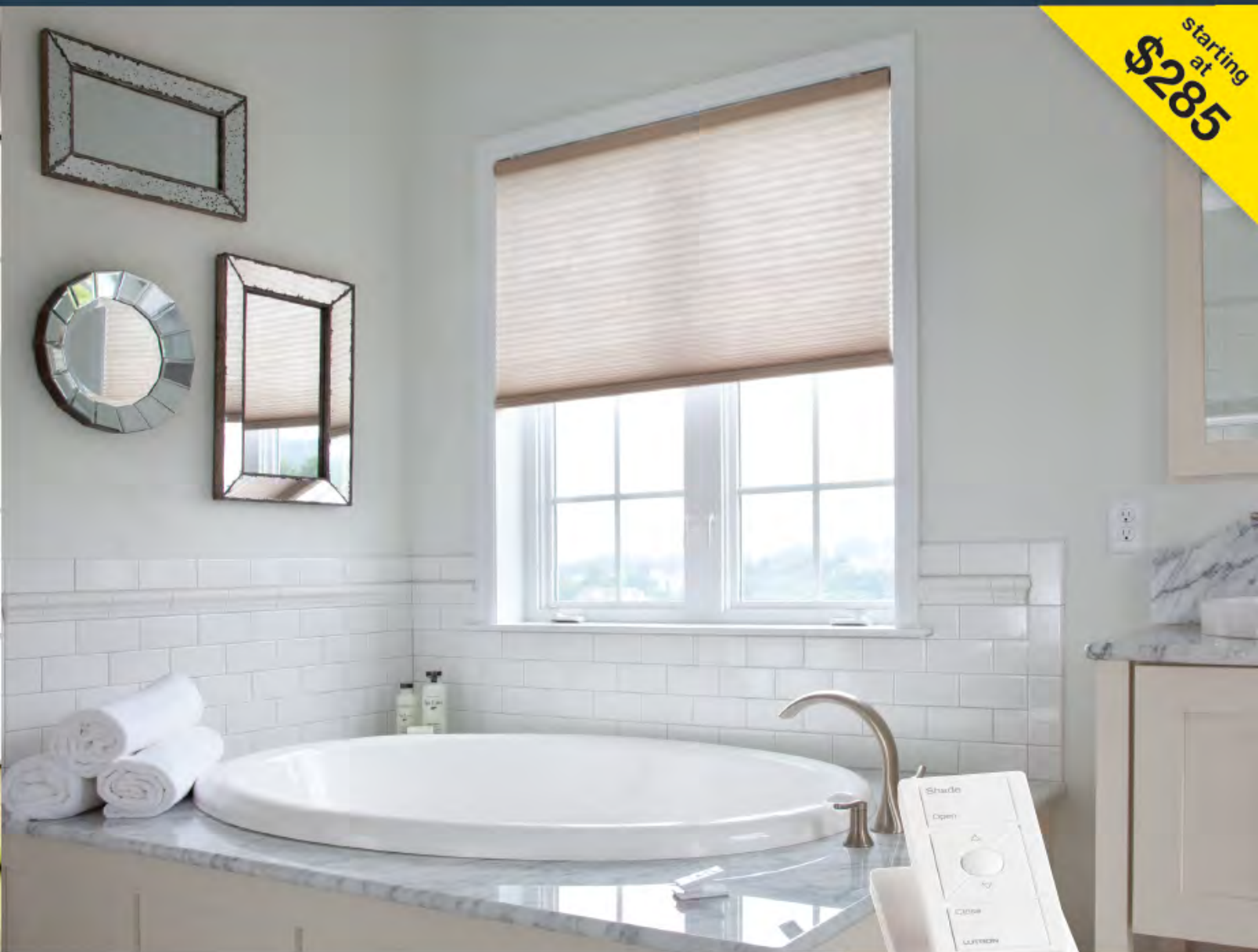

Offer solutions that are:

- **Easy to install in any room:**
 - Plug-in dimmers and battery-powered shades require no electrician
 - Wall dimmers require no new wiring
- **Programmable in seconds**
- **Affordable for any customer**

Pico wireless control on a pedestal

Battery-powered insulating honeycomb shades
starting at \$285.

Find honeycomb shades
on pages 26-27.

MEET THE STAFF

Richard started a full-service security company with in-house monitoring and armed guards in 1982. He saw the need for a one-stop distributor focusing on support and carrying a wide variety of home automation equipment in 1991 and started Worthington Distribution.



RICHARD F. SCHOLL, JR.
President

Tom spent 10 years in security and automation manufacturing and he provides technology consultation and testing for many industry manufacturers. Tom oversees Worthington University training and specializes in HAI, 2GIG, Z-Wave, lighting, mobile interfaces, distributed audio, and window treatment control.



TOM MORGAN
CTO, VP Worthington University



RICHIE SCHOLL
VP, Technical Sales

Richie has a background in information systems and has been with Worthington since its inception. His focus is on network and telephony products as well as bringing dealers the right products and systems with the support to back them up.



NOLAN MALE
Technical Sales

Nolan's background is in electrical and electronic systems with field experience troubleshooting skills. His product specialties include lighting control, Lutron RadioRA 2 and shading, whole-house audio, and HAI.

John has experience with board-level electronics and has extensive customer service experience. He plays a major role in the Worthington window treatment program and also specializes in HAI.



JOHN ZITZELMAN
Technical Sales

Steve has extensive field experience as an alarm and A/V system installer. His product specialties include surveillance systems, telephony, security, commercial audio, and HAI.



STEVE HOH
Technical Sales



BARRY HAMPE
Technical Sales

Barry has experience with computer systems and networking and has been with Worthington for 10 years. He has experience with nearly all the products we carry and specializes in the Z-Wave ecosystem and HAI.



CAROLYNN KUSHNIR
Accounts Receivable



DEBBIE SCHOLL
Customer Service



TRICIA SEYBOLD
Customer Service Manager



Dear Professional Dealer/Installer,

On behalf of the Worthington Distribution team, I proudly present our 2013 Wholesale Dealer Catalog. We offer the professional dealer/installer a single source of supply for all the products required to be successful, at the lowest cost possible. Our team of field experienced and factory trained technicians are here to assist you with pre-sales support helping you select the correct products for your application. After the sale we offer world-class tech support assisting you during installation with timely answers to your wiring and programming questions. This is a level of service and support you will not find anywhere else. Our success is dependant on your success; we are here to serve you.



Worthington Distribution has been committed to our customers and their success since we opened our doors in 1992. For more than 20 years we have been the pioneer of automation and system integration by offering the best in controllers, lighting, thermostats, structured wiring, electronic locks, security, distributed audio and video, racks, mounts and so much more. We promise our continued support making sure of your success today and in the future.

In the pages to follow you will find thousands of products from over a hundred manufacturers, allowing you to provide cost effective solutions to your customers. On behalf of everyone at Worthington Distribution, thank you for your support, and thank you for your business.

Sincerely,

Rich Scholl
President

Support and Training

We are proud to offer the best support and training in the business. Our staff has the experience and knowledge to assist when needed. We understand that your business takes you down different roads every day. You might install a lighting system this month, a video surveillance system next month, and a whole-house audio system after that. That's why we make it our priority to use the experience we have gained over time to help each one of our customers individually. The members of our tech support team have an array of the products you use every day at their fingertips to better support your efforts. Give us a try today!

We offer a wealth of knowledge in our training programs that range from 5-day classroom sessions and live webinars, to self-paced web modules that you can take at your own speed. Our training is built from our experience as well as from information provided by our manufacturers. Visit worthingtonu.com today to learn more about our training programs or to get started.

The Best Brands

We understand the importance of choosing the right assortment of brands for your company. That's why we offer multiple brands in every category. Based on factors like level of performance, price range, and installation time, we can help you narrow the choices down.

Automation and Control



Lighting



Multiroom Audio



Video Surveillance



Category Index

Automation	51-83	Security (continued)	86-107
Accessories	54-57, 59, 64-66, 68-69, 72, 77-79, 82-83	Accessories	87-88, 99-101
Audio	67	Cameras	90
Controllers	54-55, 77	Contacts	88, 94, 96, 98-99, 103-104
HVAC	61, 64, 80-81	Door Strikes/Maglocks	106-107
Lighting	62-63	Environmental	89, 94, 96-99, 104
iPad/iPod Mounts	45	Keypad Locks	87
Software/Interfaces	47-48, 70, 79, 81	Lighting	90-91, 96
Touchscreens	58-59, 77	Motion/Occupancy	88, 94, 97, 100
Wireless	60, 79	Panels	87, 91, 93, 95, 97
A/V Distribution	137-141	Wireless	87, 89, 92-93, 99
Cat 5e	141	Speakers	132-136
Standard	138-140	All Weather	135
Central Vacuum	160-162	Rock	134
Pipe/Fittings	160	In-Ceiling/In-Wall	133
Power Units	161-162	Sound Dampening	136
Energy Technologies	35-36	Subwoofers	134
Health and Wellness	84-85	Structured Wiring	163-178
Home Theater	142-150	Accessories	164, 167-169, 172, 177-178
A/V Receivers	144	Audio	167, 172-173
Cables	142	Data Modules	165, 170-171
Cooling	146	Enclosures	164, 169, 176
Mounts	150	Phone Modules	165, 169, 176
Projection	149	Power Modules	164, 169, 176
Racks	145-146, 148	RF Distribution	166, 170, 176-178
Speakers	143	Video Modules	166, 170, 176
Installation Materials	183-186	Wallplates and Inserts	166, 173, 175, 178
Accessories	183-184	Surge	37-38
Brackets/Mudrings	185-186	Battery Backup/UPS	38
iPhone/iPad Accessories	45	Structured Wiring	38
Lighting Control	6-34	Whole House	37
Boxes/Wallplates	31	Telephone/Intercom	151-159
Centralized Dimming	32-33	Intercom Retrofit and Cat 5e	159
Occupancy	16, 24, 36	Door Stations	154
RadioRA 2	20-27	Headsets	155
UPB	28-30	Intercom Systems	158-159
Z-Wave	8-18, 54, 87, 89-90	Phone Systems	153-154
ZigBee	64	Tools	179-182
Multiroom A/V	118-131	Installation	179-180, 182
Commercial	128	Labeling	181
Intercom	122	Testers	182
iPod	120	Video Surveillance	108-117
IR Distribution	126, 129-131	Cameras	110-115
Multi-Source	118-119, 121-123, 128	DVRs	109-115, 117
Single-Source	123-124, 128	IP Cameras and NVRs	110, 115, 117
Outdoor	187	Window Treatments	39-44
Security	86-107	Wire and Cable	189-191
Access Control	105-107	Combination Cable	189-191

Manufacturer Index

New Manufacturers	
Cooper	• Z-Wave Devices
EverFocus	• IP Cameras • Access Control
iRule	• Smartphone Interfaces
Jasco	• Z-Wave Devices
Key Digital	• A/V Equipment
Sillites	• Window Candles
Sonance	• Outdoor Sound Systems
SunStopper	• Awnings
Wi-Ex	• Cell Signal Booster

2GIG Technologies	18, 87-90
ACNC	158
Aeotec	14, 17, 96
Alarm.com	90
Alarm Controls	106
Aprilaire	81
Arlington	32, 183, 185
Altronix	69, 88, 102, 111-112
ATW Security	56-57, 94
AVocation	120
Baldwin	10, 65
Belden	168, 179-180
Bitwise	48
Carlson	32, 124, 184, 186
CarTell	82
CE Labs	140
CentralLite	32-34
Channel Vision	105, 154, 176-177
ChannelPlus	178
Comelit	105
CoolMaster	61
Cooper	16
Dakota Alert	83
DataComm	178
Draper	149
DSC Security	56, 91-94
Dymo/Rhino	181
Dynamat	136
ELK Products	54-55, 57, 69, 74-79, 88, 101-102
ESI	14, 44, 149
EverFocus	59, 106, 112-115
Evolve	14, 90, 96
FortrezZ	18, 89
Global Cache	46
Greenfield	72

GRI	56, 72, 103	Optoma	149
HAI	51-73, 117	PCS	28-29
HomeSeer	17	Plantronics	155
Honeywell	18, 69	Platinum Tools	141, 168, 179, 182
IntelliTouch	157	Proficient Audio	132-135
Interlogix	56, 60, 65, 95-98	Proto-Tel	68
Intermatic	15	RCS	9, 18, 68, 80, 89
Ion Security	60, 89, 99	Resolution Products	60, 72, 89, 99
iPort	45	Russound	66, 118-127
iRule	47, 70	Schlage	11, 65
Jandy	72	Seco-Larm	107
Jasco	15, 90-91	SensorSwitch	56, 72
Kwikset	10, 64-65, 88	Sherwood	144
Key Digital	138-139	Sillites	50
Legrand	31, 169-175	Simply Automated	30
Leviton	12-13, 19, 31, 35-37, 65-66, 78, 143, 164-168	Somfy	40-42, 64
Linear	85, 105, 160	Sonance	135
LogicMark	84	Speco Technologies	109-111, 128
Lutron	20-27	SunStopper	43
Luxul	49, 115, 117	Toshiba	117
M&S Systems	159	Trane	18
Macurco	56	Tripp-Lite	38, 59
Malibu	188	Universal Batteries	10, 54, 65, 83, 88, 102
MiCasaVerde	9	USP	104
Middle Atlantic	145-148	Visonic	84, 100
Mini-Clík	187	Wavenet Wire	32, 141, 143, 190-191
Muxlab	116, 141	WGL & Associates	187
NEC	152-156	Winland	72, 104
NuTone	162	Xantech	120, 129-131
Optex	56, 100	Yale	11, 64-65

Leviton Security and Automation Lock Integration

Leviton Security and Automation panels (Omni and Lumina) now have the ability to integrate with ZigBee locks from Kwikset and Yale and Z-Wave locks from Baldwin, Kwikset, Schlage and Yale.

Z-Wave integration requires the following:

- Leviton VRUSB-1US for programming (Page 12)
- Leviton VRC0P-1LW for integration (Page 13)

The VRC0P must be a "+3" version and have the latest firmware for "Beaming" to work.

ZigBee integration requires the LSA81A00-3WHZB (Page 64) which can also be used for thermostats and other "HA" profile ZigBee devices.

Baldwin	Z-Wave (Page 10)	N/A
Kwikset	Z-Wave (Page 10)	ZigBee (Page 64)
Schlage	Z-Wave (Page 11)	N/A
Yale	Z-Wave (Page 11)	ZigBee (Page 64)

To learn how to integrate locks, give us a call today!

You can also learn how to integrate locks with Leviton Security and Automation panels by visiting www.worthingtonu.com.



Elegance XL	Simply Brilliant	HAI HLC	PCS PulseWorx	Azela	OLUTRON RadiORA 2	JetStream	COOPER Z-Wave	JASCO Z-Wave	Evolve Z-Wave	LEVITON Vizia RF +	
Y	N	N	N	N	N	N	N	N	N	Y	Fan Speed Control
Y	N	N	Y	N	Y	N	Y	N	N	Y	Elec. Low Voltage
720	256	256	256	256	200	200	232	232	232	128 (232)	Max. Devices
N	Y	Y	Y	Y	Y	Y	Y	Y	Y	Y	Retrofittable
2400	900	2400	2400	800	1000	800	1000	600	1000	1000	Max. Dimmer Watt.
20	8	15	8	8	8	8	15	15	15	15	Max. Switch Amp.
Y	Y	Y	Y	Y	Y	Y	Y	Y	Y	Y	Fluorescent Lights
Bus	Coupler / Repeater	Coupler / Repeater	Coupler / Repeater	Mesh Network	Repeater	Mesh Network	Mesh Network	Mesh Network	Mesh Network	Mesh Network	Network Integrity
Central Cabinet	Neutral Required	Neutral Required	Neutral Required	Neutral Required	Standard	Neutral Required	Standard	Neutral Required	Neutral Required	Standard	Wiring
Y Built-In 2.10+	Y Built-In 2.7+	Y Built-In 2.7+	Y Built-In 2.7+	Y Built-In 3.7+	Y Built-In 3.3B+	Y Built-In 2.14+	Y Built-In 2.14+	Y Built-In 2.14+	Y Built-In 2.14+	Y Built-In 2.14+	HAI Supported
O	Y	N	Y	N	Y	In Base	N	N	Y	N	I/O Modules
N	Y	N	N	N	N	N	Y	Y	Y	Y	Controlled Recpts.
N	Fixture / Dimming	N	Y	N	N	N	N	N	Y	N	Wired Modules
RS-232	RS-232 PIM	RS-232 PIM	RS-232 PIM	RS-232 ZIM	RS-232	RS-232 PIM	RS-232 PIM	RS-232 PIM	RS-232 PIM	RS-232 PIM	Req. HAI Interface
N/A	L,A	L,A	L,A	L,A	L,A	N/A	L,A	L,A	L,A	L,A	Plug-In Modules
Y	N	Y	Y	Y	Y	Y	N	N	N	Y	Two-Way w/ HAI
N	N	N	N	N	Y	N	Y	N	N	Y	Two-Wire w/ HAI
Y	Y	Y	Y	Y	Y	Y	Y	Y	Y	Y	Scene Capable*
N	N	O	Y	N	Y	Y	Y	Y	N	Y	Wireless Remote
Wired	UPB			Wireless/RF							

Y=Yes; N=No; O=Available as an Option; N/A=Not Available; L=Lamp; A=Appliance

**Dimmable fluorescents supported

The information in this chart was gathered from manufacturer websites, tech support and literature. Confirm specs with manufacturer prior to ordering. Worthington Distribution's knowledgeable staff can help with any questions you may have.



ZigBee

A wireless technology with many chip manufacturers and implementations. Look for products that use the Home Automation profile. Before the Home Automation profile, all ZigBee products used the same radio technology but products were not interoperable (p. 64).

Z-Wave

A wireless technology with a standardized radio protocol. Z-Wave solutions exist for more than just lighting. It is an RF technology for total home control. Products are available from Leviton (p.12-13) and many additional vendors (p. 9-19).

OmniBus

Leviton Security and Automation's OmniBus is a hard-wired lighting system that features exceptional speed and reliability. Programmable dimming curves provide a wide range of compatibility with different lighting loads (p. 62).



RadioRA 2

A wireless total home control system engineered to be as solid as a hardwired system. The ultra-reliable fixed repeater network is flexible for retrofit and new installations. It is a scalable solution for basic to the most advanced applications (p. 20-27).

Hard-Wired Lighting

When it comes to speed and reliability, there is no substitute for a hard-wired lighting system. CentralLite's Elegance XL (p. 32-33) is the value leader for any size home. Dimming cabinets combined with multi-button keypads eliminate wall clutter.

Universal Power Line Bus (UPB)

A reliable powerline technology, UPB is available from 3 companies: PCS (p.28-29), Leviton Security and Automation (p.12) and Simply Automated (p. 30). HAI users can program devices from the controller. Other implementations use free UPStart PC programming software.

Scene Lighting

Controlling groups of lights with a single command can change a room's look and feel at the touch of a button. Dimmers can be used to set a mood in a room and to draw attention to architectural elements.

Window Treatments

Drapes, shades, blinds and other motorized treatments can be used as natural light control. In many cases the window treatments can be integrated with the lighting systems for total room control (p. 39-44).

Remote Access

We are now in the age of PDAs and Smart Phones. Why not control your home from your own web page or home control application? (p. 70-71)

Convenience

Timers are typically used to control lights for holidays and security applications. Why not centralize all of the timers into a single controller? In addition, add the simplicity of All Off when you go to bed. Lighting can now be controlled by more than just time.

Energy Management

As energy prices continue to increase, consumers are looking for ways to control high-wattage devices. Current technologies make it easy to control lighting as well as high-wattage devices such as the hot water heater.

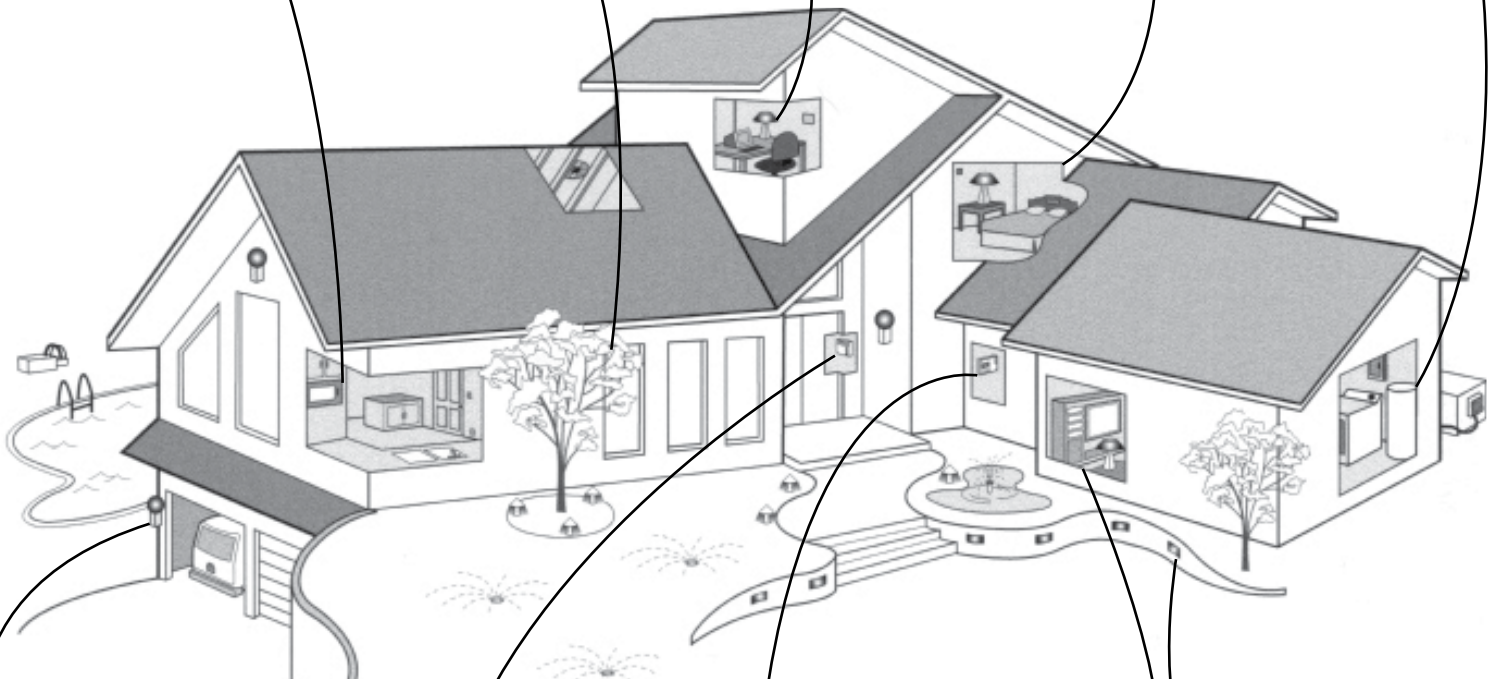

Security Integration

Lighting control is an excellent addition to any security application. Turn lights on at sunset and off later in the evening. Pathway lighting reduces the potential for falls and vehicle detection (p. 82-83) can be used to turn on key lights and alert the homeowner to a vehicle arriving.

Temperature Control

The largest consumer of energy in the home is the HVAC system. Many lighting communication technologies include thermostat control (p. 61).

Home Theater

Lighting is a key element for controlling both room lighting and natural light for the proper viewing atmosphere. See solutions for iPad control via the Leviton Security and Automation SnapLink Mobile applications.

Landscape Lighting

Outdoor lighting is profitable and easy to control. Many lighting control systems can control magnetic loads. Simply check for load types when choosing the proper dimmer.



Understanding Z-Wave Technology



Products that speak Z-Wave work together better™

Z-Wave - A Mesh Network



- Z-Wave is a 900MHz radio frequency mesh network communication technology which allows devices in the home to work together
- A key advantage of Z-Wave is that all Z-Wave devices can be added to any Z-Wave network
- Z-Wave is a communication standard at both the radio and protocol level. This ensures all Z-Wave products can work together (see Z-Wave - Interoperability for further details).
- Being a mesh network, Z-Wave uses other devices already on the network to deliver messages from one device to another. This applies to all devices that are plugged in or permanently powered. Battery devices do not repeat messages.
- The more devices that exist on a Z-Wave network, the better the network coverage
- To achieve Z-Wave certification, a Z-Wave device must be able to achieve 75' open air communication
- Due to construction materials and large metal objects, plan on typical installed communication distances of 30' to 35'

Z-Wave - Beaming

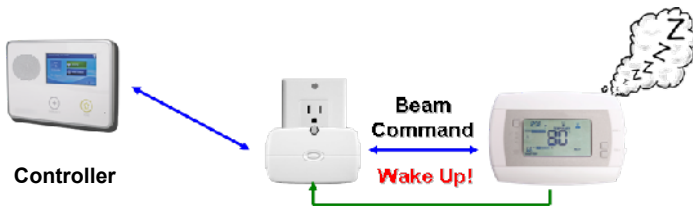

- Not all Z-Wave devices are the same. The Beam Command was introduced after the initial Z-Wave release.
- Second generation devices like the 2GIG Thermostat and Z-Wave locks run on batteries and have 2-way communication
- To increase Z-Wave communication distances (repeating), modules with Beam Command support are required to wake up the thermostat or lock to deliver a message
- Worthington Distribution routinely points out products which are beaming compatible, ensuring you choose devices which will aide communication to locks and battery powered thermostats

Z-Wave - Primary Controller

- Every Z-Wave network is created with a primary controller
- The primary controller is responsible for adding and removing devices to the Z-Wave network
- There are 3 different approaches to Z-Wave networking using different types of controllers



• The Handheld

- The handheld remote control is great for stand-alone lighting installations
- Most handheld remote controls provide network setup and control
- Most handheld remote controls do not support lock communication



• The Gateway Controller

- A gateway controller often (but not always) connects to a Local Area Network (LAN) and provides Z-Wave control in the home and from mobile interfaces such as an iOS device or Android phone
- Most gateway controllers provide basic primary remote functions along with more advanced network maintenance functions and lock communication setup



• PC USB Controller

- A PC USB stick is typically used by the professional installer to set up and save a Z-Wave configuration
- Often the network is set up with the USB stick and the stick leaves with the installer
- Popular automation controllers from Leviton Security and Automation and ELK use the Leviton USB stick to setup the Z-Wave network and 2-way communication with the Leviton VRC0P-1LW interface



Z-Wave - Interoperability



- All Z-Wave devices can be learned into all Z-Wave networks; however, that does not mean that all Z-Wave devices are the same and offer the same features
- Z-Wave products are permitted to have their own unique feature sets providing they adhere to the standard set of features
- The most important example of product differentiation in the Z-Wave ecosystem centers around lighting devices. To know if a light is on or off, the controller should poll the device for a status update. Both Leviton and Cooper are unique because they have the ability to tell a controller or keypad that their status has changed without being polled. Please note: only Leviton update messages are compatible with Leviton Security and Automation.
- Since Z-Wave technology is constantly evolving and manufacturers are permitted to offer differentiating features, it is recommended to check compatibility before purchasing products

MiCasaVerde Vera Smart Home Controller

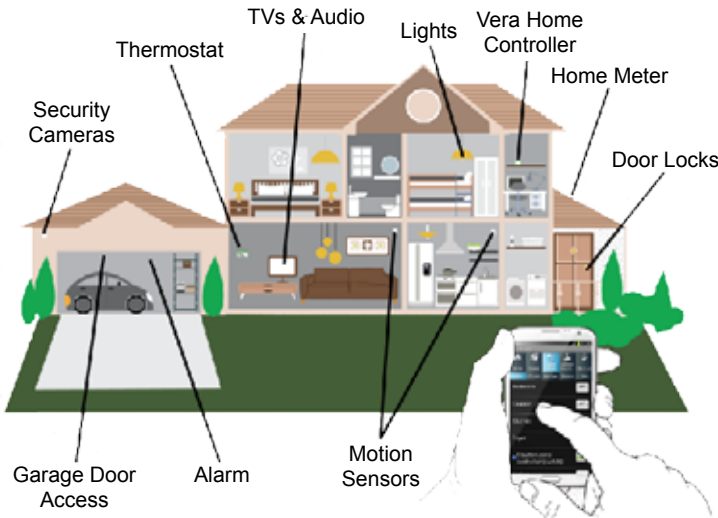

- No Monthly Fee: Secure, remote access from any web enabled device
- MiCasaVerde guarantees compatibility with all Z-Wave devices including locks, scene controllers, sensors, lighting controllers, thermostats, energy metering and more
- Vera's advanced energy metering capabilities allow homeowners to take control of their energy bill and start saving money
- Stream live video from IP cameras; store video footage on MiCasaVerde's secure servers that can be accessed from anywhere
- Bridge multiple Vera controllers over Ethernet, allowing 2 separate Z-Wave networks to operate as a single system
- No broadband connection is needed for local control. Vera can be set-up and configured without an internet connection
- MiOS, Vera's home control engine, has open architecture allowing developers to create new Apps and products that can integrate with Vera
- There is an active Mi Casa Verde community that offers applications that extend the capabilities of a Vera. Examples include weather forecasting, media control, alarm panel integration, and remote live video streaming.

See page 15 for the Intermatic Z-Wave Pool/Spa controller



MICVERALITE



MICVERA3-US

MICVERA3-US	Vera3 smart home controller and network router with 4 LAN ports. Includes 128MB of memory for add-on applications. Built in Wi-Fi.	169.24
MICVERALITE	VeraLite smart home controller. Includes 64MB of memory for add-on applications.	106.02

Z-Wave Interoperability

MiCasaVerde guarantees compatibility with all Z-Wave certified devices

<p>The MiCasaVerde Smart Home Controller</p> <p>The MiCasaVerde Smart Home Controller works with all Z-Wave certified devices</p>	<p>Sensors</p> <p>Z-Wave sensors report activity. Control Z-Wave devices or receive notifications based on sensor activity.</p>	<p>Electronic Locks</p> <p>Lock doors at night or open the door for guests from anywhere in the world. Receive notifications when the door is unlocked.</p>
<p>Wireless Cameras</p> <p>Keep an eye on your home from an iOS or Android mobile phone</p>	<p>Thermostats</p> <p>HVAC systems consume the largest amount of residential electricity. Z-Wave thermostats make saving energy easy.</p>	<p>Lighting Controls</p> <p>Z-Wave technology offers a wide range of control devices to simplify a homeowner's life or save energy</p>

MiCasaVerde Control Modules

MICSMARTSWITCH	Z-Wave Appliance Switch with current monitoring	39.97	
----------------	---	-------	--



- Z-Wave load control
- Great for power consumption measurement and control of larger electrical loads such as Electric Water Heaters and Pool / Spa Pumps
- PMC version adds current measurement
- Current can be read via Z-Wave by MiCasaVerde Vera and other Z-Wave metering class compatible controllers
- Power measurement with +/- 1% accuracy
- 2 – 120, 208, 240 Volt, 30 Amp Contactor Relays
- Local On / Off Control
- LED network status indicator
- Push button switch for network enrollment
- Nema-4X, 6P Enclosure

RCSPC30	Z-Wave Controlled 30 Amp Contactor 120/208/240 VAC	186.41
RCSPMC30	Z-Wave Controlled 30 Amp Contactor 120/208/240 VAC with current sensing	214.52

Note: At the time of the catalog printing, the load reporting features in PMC30 were confirmed to be compatible with the MiCasaVerde Vera

Mobile Application Control

- MiCasaVerde's applications for Android and iOS are free
- There is no charge for accessing Vera from the Internet
- Support for Vera control as well as MiCasaVerde IP cameras

MiCasaVerde IP Cameras



MICVISTACAMSD



MICVISTACAMHD



MICVISTACAMPT

MICVISTACAMSD	640 x 480 Standard Definition Wide Angle Wireless Camera, Microphone, 20' IR Night Vision, SD Card Support	59.41
MICVISTACAMPT	640 x 480 Standard Definition Pan and Tilt Wireless Camera, Microphone with 2-way audio, 20' IR Night Vision, SD Card Support	59.41
MICVISTACAMHD	1280 x 720 High Definition 720p Pan and Tilt Wireless Camera, Microphone with 2-way audio, 35' IR Night Vision, SD Card Support	148.59



Kwikset Locks

One of the hottest technologies in the Z-Wave marketplace is access control. Historically it has been difficult to know if doors are locked at night. In addition, there are times when you would like to open the door for a visitor. Entry set and deadbolt solutions now solve these issues, making it easier to provide access control over Z-Wave and the Internet.

- Motorized Tapered Deadbolt
- Includes SmartKey® Re-key Technology with BumpGuard™ Protection
- Indoor temperature range 32°F to 176°F
- Outdoor temperature range -40°F to 176°F
- Directly supported by 2GIG, MiCasaVerde, and HomeSeer
- Support via the Leviton VRC0P (rev 3) Z-Wave interface with Leviton Security and Automation and ELK
- When using the Leviton VRC0P, it is recommended to use the Leviton VRUSB-1US USB stick (page 12) and the free Leviton RFinstaller software to set up and configure the Z-Wave network

Kwikset



Entry Set



Standard



Contemporary

Looking for ZigBee? See page 64

Kwikset Z-Wave Motorized Deadbolts

BD99100-*** Z-Wave Motorized Deadbolt 168.62

*** Standard Deadbolt
004-Polished Brass, 005-Satin Nickel, 006- Venetian Bronze

*** Contemporary Deadbolt
011-Satin Nickel, 012-Satin Chrome, 013-Polished Chrome, 014-Venetian Bronze

Kwikset Non-RF Motorized Deadbolts

BD99090-*** Motorized Deadbolt (no communication) 168.62

*** Standard Deadbolt
001-Polished Brass, 002-Satin Nickel, 003- Venetian Bronze

*** Contemporary Deadbolt
007-Satin Nickel, 008-Satin Chrome, 0009-Polished Chrome, 013-Venetian Bronze

Kwikset Z-Wave Motorized Lever Locks

BD99120-*** Z-Wave Motorized Lever Lock 168.62

*** 004-Polished Brass, 005-Satin Nickel, 006- Venetian Bronze

Kwikset Non-RF Motorized Lever Locks

BD99110-*** Motorized Lever Lock (no communication) 168.62

*** 001-Polished Brass, 002-Satin Nickel, 003- Venetian Bronze

Baldwin Locks



Baldwin products are built to order. Baldwin is available as a special order.

SOHO Style Boulder Style

- Motorized Tapered Deadbolt
- Elegant Finishes with uncompromising build quality
- Uses a 'C' keyway allowing for easy re-keying
- Indoor temperature range 32°F to 176°F
- Outdoor temperature range -40°F to 176°F
- Directly supported by 2GIG, MiCasaVerde, and HomeSeer
- Support via the Leviton VRC0P (rev 3) Z-Wave interface with Leviton Security and Automation and ELK
- When using the Leviton VRC0P, it is recommended to use the Leviton VRUSB-1US USB stick (page 12) and the free Leviton RFinstaller software to set up and configure the Z-Wave network
- Full handle sets with a motorized deadbolt are available as a special order
- Note, full handle sets are built to order and can take 4-6 weeks for delivery

BD8252003AC3	Boulder Style Z-Wave Motorized Deadbolt: Polished Brass	371.58
BD8252102AC3	Boulder Style Z-Wave Motorized Deadbolt: Oil Rubbed Bronze	352.84
BD8252112AC3	Boulder Style Z-Wave Motorized Deadbolt: Venetian Bronze	352.84
BD8252402AC3	Boulder Style Z-Wave Motorized Deadbolt; Distressed Oil Rubbed Bronze	371.58
BD8285056AC3	SOHO Style Z-Wave Motorized Deadbolt: Lifetime Satin Nickel (salt air/harsh weather)	371.58
BD8285150AC3	SOHO Style Z-Wave Motorized Deadbolt: Satin Nickel	352.84
BD8285260AC3	SOHO Style Z-Wave Motorized Deadbolt: Polished Chrome	352.84
BD8285264AC3	SOHO Style Z-Wave Motorized Deadbolt: Satin Chrome	352.84

Integrating Locks

- **Z-Wave Controllers**
 - Controllers with Z-Wave built-in like 2GIG and MiCasaVerde enroll the lock directly
- **Leviton VRC0P-1LW Serial Interface**
 - Compatible with Leviton Security and Automation, ELK, and other controllers
 - A Leviton USB stick is used with Leviton software to set up and save the Z-Wave configuration
 - Installation videos are available on worthingtonu.com
- **Enrollment Tips**
 - Always use devices that are 'beaming compatible' when expanding the network
 - When learning a lock be certain the lock is close to the controller or USB stick
 - If a Z-Wave device (including the lock) is moved, use the Z-Wave 'rediscover' option in the controller or software



Batteries

UB6AM-6ALK	9V battery for Schlage deadbolts	1.58
UBD5312	AA battery for Schlage deadbolts and entry sets, Yale deadbolts, Kwikset deadbolts and entry sets and Baldwin deadbolts. Priced each, sold in packs of two.	0.40



Don't forget the batteries!



Kwikset/Baldwin/Yale	Requires 4x "AA" batteries - UBD5312
Schlage Deadbolt	Requires 4x "AA" batteries - UBD5312 and 1x "9V" battery - UB6AM-6ALK
Schlage Entry Set	Requires 4x "AA" batteries - UBD5312



- Push button or capacitive interfaces
- Optional keyways
- Indoor temperature range 5°F to 140°F
- Outdoor temperature range 5°F to 140°F
- Directly supported by 2GIG (v1.9), MiCasaVerde, and HomeSeer
- Support via the Leviton VRC0P (rev 3) Z-Wave interface with Leviton Security and Automation and ELK
- When using the Leviton VRC0P, it is recommended to use the Leviton VRUSB-1US USB stick (page 12) and the free Leviton RFinstaller software to set up and configure the Z-Wave network
- Yale deadbolts come standard with a K Keyway
Looking for ZigBee? See page 64



Z-Wave Communicating Deadbolts		
YALD220ZW+	Motorized Z-Wave Deadbolt with capacitive touch keypad	206.08
YALD240ZW+	Keyless Motorized Z-Wave Deadbolt with capacitive touch keypad. No lock cylinder.	206.08
YALD210ZW+	Motorized Z-Wave Deadbolt with pinpad	168.62
(+605-Bright Brass, 0BP-Oil Rubbed Bronze, or 619-Satin Nickel)		

Lever Options for Yale Lever Locks (Norwood Is Standard)		
YALYR05D8+*	Alternate levers for Yale Lever Locks	19.73
+ 2-Cascade, 3-Milan, 4-Marina, 5-McClure, 7-Academy, 8-Norwood * 3-Polished Brass, N-Satin Nickel, K-Oil Rubbed Bronze		



Cylinder Options for Yale Locks		
YALAD200KWKA+	Deadbolt Kwikset Barrel, keyed alike	7.04
YALAD200SCKA+	Deadbolt Schlage Barrel, keyed alike	7.04
YALAD200SCKD+	Deadbolt Schlage Barrel with key	7.04
YALALKWKA+	Lever Kwikset Cylinder, keyed alike	7.04
YALALSCKA+	Lever Schlage Cylinder, keyed alike	7.04
YALALSCKD+	Lever Schlage Cylinder with key	7.04
+ 03-Polished Brass, 26-Chrome		

Keyway Options		
YALAD200KWKA*	Kwikset Barrel for Yale locks, keyed alike	7.04
YALAD200SCKA*	Schlage Barrel for Yale locks, keyed alike	7.04
YALAD200SCKD*	Schlage Barrel for Yale locks, keyed different	7.04
*Use 26 for Satin Nickel and 03 for Brass and Oil Rubbed Bronze		

Z-Wave Communicating Entry Lever Sets		
YALL220ZW+	Motorized Z-Wave Entry Lever Set with capacitive touch keypad	206.08
YALL210ZW+	Motorized Z-Wave Entry Lever Set with pinpad	187.35
(+605-Bright Brass, 0BP-Oil Rubbed Bronze, or 619-Satin Nickel)		

Non-Communicating Locks		
YALD220NR+	Motorized Deadbolt with capacitive touch keypad (no communication)	149.88
YALD240NR+	Keyless Motorized Deadbolt with capacitive touch keypad. No lock cylinder. (no communication)	149.88
YALD210NR+	Motorized Deadbolt with pinpad (no communication)	112.41
YALL220NR+	Motorized Entry Lever Set with capacitive touch keypad (no communication)	149.88
YALL210NR+	Motorized Entry Lever Set with pinpad (no communication)	131.14
(+605-Bright Brass, 0BP-Oil Rubbed Bronze, or 619-Satin Nickel)		

Schlage Locks

- Directly supported by 2GIG (v1.10), and MiCasaVerde
- Support via the Leviton VRC0P (rev 3) Z-Wave interface with Leviton Security and Automation and ELK
- When using the Leviton VRC0P, it is recommended to use the Leviton VRUSB-1US USB stick (page 12) and the free Leviton RFinstaller software to set up and configure the Z-Wave network

Nexia Z-Wave Gateway		
SCHBR100NX	Nexia Home Gateway	59.48
The Nexia Gateway requires an \$8.99 monthly subscription		
Nexia Plug-In Modules		
SCHRP200RNX	Nexia Lamp Module	42.22
SCHRP100RNX	Nexia Appliance Module	42.22
Nexia Z-Wave Sensors		
SCHRS100HC	Nexia Door/Window Sensor with external input	33.29
SCHRS200HC	Nexia Motion Detector	47.09
Nexia Cameras		
SCHWCW100NX	Nexia Indoor Camera	145.32
SCHWCO100NX	Nexia Wireless Indoor Camera	163.59
SCHWCE100	Nexia Wireless Outdoor Camera	145.32



Z-Wave Communicating Deadbolts		
SCHBE469CAM*	Camelot Z-Wave Motorized Touchscreen Deadbolt: *505-Bright Brass, 619-Satin Nickel, 716-Aged Bronze, 625-Bright Chrome	174.96
SCHBE469CEN*	Century Z-Wave Motorized Touchscreen Deadbolt: *619-Satin Nickel, 625-Bright Chrome, 626- Satin Chrome	174.95

Z-Wave Communicating Entry Lever Set		
SCHFE599*	Z-Wave Entry Lever Set with electronic clutch: * 505-Bright Brass, 619-Satin Nickel, 716-Aged Bronze	164.81

Non-Communicating Deadbolts and Entry Sets available. Call for pricing.

Vizia RF +® Dimmers

LEVRI06-1LZ	Vizia RF + 600W incandescent scene capable dimmer, LED locator and brightness display, no neutral required, single pole or 3-way, beaming compatible*	73.35
LEVRI10-1LZ	Vizia RF + 1000W incandescent scene capable dimmer, LED locator and brightness display, no neutral required, single pole or 3-way, beaming compatible*	86.42
LEVVRM1-1LZ	Vizia RF + 1000W incandescent, magnetic low voltage and Mark X scene capable dimmer, LED locator and brightness display, neutral required, single pole or 3-way, beaming compatible*	138.56
LEVRE06-1LZ	Vizia RF + 600W electronic low-voltage scene capable dimmer, LED locator and brightness display, neutral required, single pole or 3-way, beaming compatible*	178.04

White, Ivory, and Light Almond colors included

vizia rf +™



Vizia RF + Dimmers

Vizia RF + Fan Speed Control

LEVRF01-1LZ	Vizia RF + 1.5A quiet fan controller, LED fan speed display, single pole or 3-way, beaming compatible*. White, Ivory, and Light Almond included	122.26
-------------	---	--------

Vizia RF + Switches



Vizia RF + Switches



LEVVRCS2-MRZ

LEVRS15-1LZ	Vizia RF + 15A scene capable switch with LED locator; neutral required, single pole or 3-way, beaming compatible*	81.50
LEVRS05-1LZ	Vizia RF + 5A incandescent scene capable electronic switch with LED locator, no neutral required, single pole or 3-way, beaming compatible*	73.35
LEVVRCS2-MRZ	Vizia RF + dual switch. Each switch 1000W, 1/4 HP, 1000VA, neutral required, beaming compatible*	127.92

White, Ivory, and Light Almond colors included

Vizia RF + Outlet

LEVRR15-1LZ	Vizia RF + Tamper Resistant split 15A Outlet, beaming compatible*	95.77
-------------	---	-------

White, Ivory, and Light Almond colors included

Vizia RF + Wall Controllers

LEVVRCS4-M0Z	Vizia RF + 4-Button Scene Controller: 4 buttons, dim, bright, IR, beaming support	109.55
LEVVRZ4-M0Z	Vizia RF + 4-Button Zone Controller: 4 on/off rockers, dim, bright, IR, beaming support	115.03
LEVVRCS1-1LZ	Vizia RF + 1-Button Scene Controller: virtual switch remote, beaming compatible*	65.97
LEVVRZ1-1LZ	Vizia RF + 1-Button Zone Controller: virtual dimming remote, beaming compatible*	65.97
LEVVRMR1-SG	Vizia RF + IR Handheld Remote Controller	25.38

White, Ivory, and Light Almond Colors Included

Receive free engraving for newly purchased Vizia RF+ 2 and 4 button controllers. Requires completion of an engraving request form. Call for details.



LEVVRZ4-M0Z
LEVVRZ4-MRZ

Zone Controllers

- 4 On / Off Rockers (Left on, Right off)
- Dim / Bright
- IR Receiver
- Control loads On / Off



LEVVRCS4-M0Z
LEVVRCS4-MRZ

Scene Controllers

- 4 Buttons (single push)
- Dim / Bright
- IR Receiver
- Control scenes On / Off

Note: Each button on both Vizia RF + controllers can be programmed for zone or scene control.

Vizia RF + Wall Controls with Load Switching

LEVVRCS4-MRZ	Vizia RF + 4-Button Scene Controller with Switch. 1800W, 1/2HP, 1800VA	168.84
LEVVRZ4-MRZ	Vizia RF + 4-Button Zone Controller with Switch. 1800W, 1/2HP, 1800VA	168.84

White, Ivory, and Light Almond colors included

See page 19 for matching Non-RF Vizia RF + Devices

Convert a Leviton Controller to a Tabletop Controller

LSA138A15-*	Tabletop cradle. Use with Leviton controllers (non-load) *WH-White, BL-Black	30.32
-------------	--	-------

Vizia RF + Plug-In Modules

LEVVRP15-1LW	Vizia RF + 15A scene capable plug-in appliance module, beaming compatible*	70.09
LEVVRP03-1LW	Vizia RF + 300W dimming plug-in lamp module with beaming support	63.57
LEVVRCP0P-1LW	Vizia RF + plug-in Z-Wave interface with beaming support, Use with HAI controllers. Includes HAI RJ-11 and standard serial cable.	89.15 or FREE

Receive a FREE Vizia RF + serial module when purchasing \$500 of Vizia RF +. Call for details.



LEVVRP03-1LW



LEVVRCP0P-1LW

* Mid 2013 Vizia RF + will transition to beaming compatible. Beaming compatibility will be identified on the device and product packaging.

Program Vizia RF +[®] from a PC with Vizia RF + Installer Software

LEVVRUSB-1US	USB adapter for use with the Leviton Vizia RF+ Installer software	69.92
--------------	---	-------

Download the FREE Vizia RF + Installer Software from www.leviton.com/rfinstaller

- Vizia RF + is based on Z-Wave Technology
- The vizia RF+ Installer software is used to set up the Z-Wave network
- A great solution for new construction or retrofit
- Each powered Z-Wave device can repeat signal to create a mesh network
- The more devices the better the coverage
- For applications up to 7,500 sq / ft or 128 devices
- Vizia RF+ Installer Software can enroll Z-Wave thermostats and locks
- Open air Z-Wave range is 75 feet or better. When designing a system, plan on having a Vizia RF + device at least every 30 to 35 feet.

Integrating Vizia RF + with Leviton Security and Automation

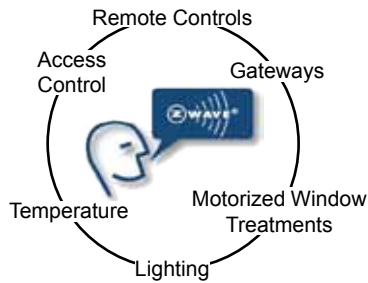

Advantages of Z-Wave

- More than 160 companies participate in the Z-Wave Alliance
- Unlike many other technologies which focus purely on lighting, Z-Wave has been designed to control all of the major sub-systems in a home
- Z-Wave provides interoperability both at the physical level (RF) and the protocol level allowing all Z-Wave products to interoperate
- All Z-Wave enabled devices have baseline connectivity; however, not all

Z-Wave devices are created equal. Look to connectivity partners such as Leviton Vizia RF + with Leviton Security and Automation for fully integrated 2-way communication.



#1: Set up the Vizia RF + network using the Vizia RF+ Installer software or the installation checklist on a primary remote

#2: Enroll a serial interface.

- Using RF+ Installer: Learn each Z-Wave device into the network (including Z-Wave Locks)
- Under Diagnostics choose RS-232 Setup
- Map all of the Leviton devices and locks back to the serial interface

#3: Connect the serial interface to Leviton Security and Automation controller using the supplied black cable. Set the serial port mode to Z-Wave.

#4: Name the Vizia RF + devices using Programming on the 8's. Input the Vizia RF + node IDs into PC Access and download.

Labeling Vizia RF + 4-Button Controllers

LEVVRKIT-0DS	Custom labeling for the VRCS2 2-button Controller / Dual Switch: order form required	FREE
LEVVPKIT-0S4	Custom labeling for the 4-button scene controllers: order form required - per keypad	FREE
LEVVPKIT-0Z4	Custom labeling for the 4-button zone controllers: order form required - per keypad	FREE
LEVVPSLB-S4*	Label kit for the Vizia RF + VRCS4-M0 4-button scene controller	39.31
LEVVPZLB-Z4*	Label kit for the Vizia RF + VRCZ4-M0 4-button zone controller	45.69

*W-White, I-Ivory, G-Gray, E-Black, B-Brown, R-Red, T-Light Almond



When setting up systems with the VRC0P-1LW Serial Interface use the LEVVRUSB-1US with Vizia RF + Installer software

Vizia RF + Handheld Remotes

LEVVRCPG-BSG	Vizia RF + handheld remote controller programmer with thermostat support	142.11
LEVVRCPG-SG	Vizia RF + handheld remote controller programmer with thermostat support and timer. Includes internal astronomical clock, power supply and rechargeable batteries.	155.34
LEVVRMR1-SG	Vizia RF + IR handheld remote controller	25.38



LEVVRMR1-SG



LEVVRCPG-SG

Vizia RF + Hardwire 3-Way Remotes

LEVVP00R-1LZ	Matching dimmer remote with LED indicators and dim/bright, neutral required	17.67
LEVVP00R-10Z	Coordinating dimmer remote with dim/bright, no LEDs, neutral optional	15.09
LEVVP0SR-1LZ	Matching switch remote with LED locator, neutral required	8.93
LEVVP0SR-10Z	Coordinating switch remote, no LED, neutral optional	6.37

White, Ivory, and Light Almond included

Vizia RF + Color Change Kits

LEVVPKIT-MD*	Matching dimmer color change kit: VRI06, VRI10, VRMx1, VRE06, VRF01, and VP00R-1L	1.91
LEVVPKIT-CD*	Coordinating dimmer color change kit: VP00R-10	1.91
LEVVPKIT-MS*	Matching switch color change kit: VRS15-1L, VRS05-1L and VP0SR-1L	1.91
LEVVRKIT-R0*	Color change kit for VRR15-1L (Almond not available)	9.09

*W-White, I-Ivory, G-Gray, E-Black, B-Brown, R-Red, T-Light Almond

Vizia RF + Wall Controller Color Change Kits

LEVVPKIT-MS*	Color change kit for the Vizia RF + VRCS1-1L 1-button virtual switch remote	1.91
LEVVPKIT-MD*	Color change kit for the Vizia RF + VRCZ1-1L 1-button virtual dimmer remote	1.91
LEVVPKIT-S4*	Color change kit for the Vizia RF + VRCS4-M0 4-button scene controller	17.87
LEVVPKIT-Z4*	Color change kit for the Vizia RF + VRCZ4-M0 4-button zone controller	17.87
LEVVRKIT-DS*	Color change kit for the Vizia RF + VRCS2 (see page 8) dual switch	10.44

*W-White, I-Ivory, G-Gray, E-Black, B-Brown, R-Red, T-Light Almond

Z-Wave Dimmers and Switches



- All Evolve devices have Beam Command support
- Recommended for expanding a Z-Wave network that includes locks and 2-way battery devices



EVOLRM-AS*	Evolve Z-Wave 500W incandescent dimmer, LED locator, neutral required, single-pole. See note to the right for 3-way applications.	39.90
EVOLSM-15*	Evolve Z-Wave 15A incandescent and inductive switch, neutral required, single-pole. See note to the right for 3-way applications.	39.90
EVOLFM-20	Evolve Z-Wave in-line fixture module, neutral required, isolated relay rated for up to 20A@120VAC Inductive or Resistive and 960W incandescent	51.90

*Blank-White, A-Almond - Call for availability in BR-Brown and BK-Black

Z-Wave Thermostat

EVOT-100R	Evolve Z-Wave Thermostat, single, multi-stage, or heatpump, common required	132.90
-----------	---	--------

Evolve LCD Screens

Evolve LCD Screens are attractive, backlit Z-Wave keypads that can be mounted in a single gang box or as a tabletop display. Power from 12VDC or an included box mounted power supply. Compatible with TaHoma, Vera and HomeSeer.



EVOLCD-1*	5-button single gang scene controller with LCD display and power supply, backlit button surrounds *(Blank-White, A-Almond)	189.90
EVOLCD-1T	5-button tabletop scene controller with LCD display and power supply, backlit button surrounds, black	199.90

Evolve Virtual 3-Ways

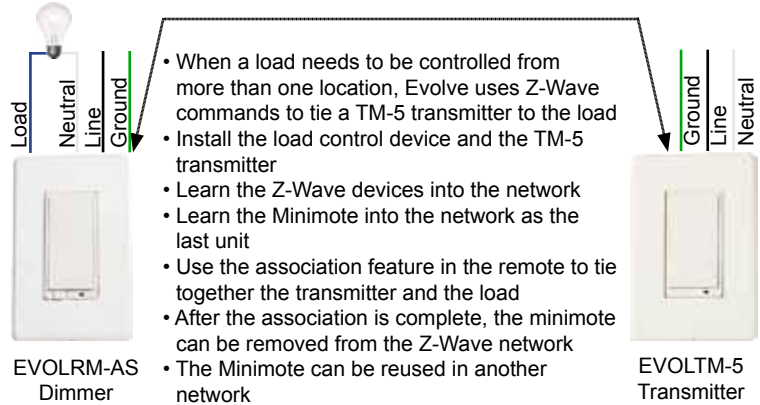

EVOLTM-5*	Evolve Z-Wave transmitter for "virtual" 3-ways, top on / bottom off and hold for dim / bright functions, neutral required, *Blank-White, A-Almond	39.90
AEODSA03202*-US	Minimote, use to create RF 3-way associations between the EVOLTM-5 and Evolve load devices *B-Black or W-White	42.84

Z-Wave Outlet

EVOLOM-15*	Evolve Z-Wave 15A switched outlet, neutral required, top controlled, bottom always on, LED indicator and manual control button on face. See note below for 3-way applications.	39.90
------------	--	-------

*Blank-White, A-Almond

Plug-In Modules

EVOLDM-15	Lamp module, 300W plug-in, dimmable	39.90
EVOLPM-15	Appliance module, 15A plug-in, relay	39.90

Evolve Color Change Kits

EVOTR-RM-*	Color Change Kit for LRM-AS and LRM-1000	4.00
EVOTR-SM-*	Color Change Kit for LSM-15/LTM-5	4.00

*Available in A-Almond, BR-Brown and BK-Black

Z-Wave Motor Control for AC or DC Limit Switch Motors



Electronic Solutions Z-Wave motor control interface provides Z-Wave control of standard limit switch motors. Innovative circuitry allows the interface to provide motor position feedback as well as commands to place the motor in a specific position. Works with all Z-wave devices that can control lighting.



		MAP \$	Dealer
ESIDBMZ908	Z-Wave interface for low voltage (2A@24VDC) 2-wire limit switch motors	217.00	Call
ESIABMHZ115908	Z-Wave interface for 3-wire 115 VAC limit switch motors	259.00	Call
ESIABMHZ230908	Z-Wave interface for 230 VAC limit switch motors	259.00	Call
ESITZ3300908	Z-Wave 5-Channel Remote Control	N/A	85.93

ESI Z-Wave interfaces have MAP price restrictions. Call for your low dealer price.



Dimming LED and CFL bulbs typically require a dimmer with a neutral. Please check compatibility.		GE		JASCO®	
In-Wall Dimmers		Part	Dealer	Part	Dealer
In-Wall Decorator Style Dimmer, 600W Incandescent, beaming compatible, White		JAS45612	37.41	JAS45612WB	33.72
In-Wall Decorator Style Dimmer, 600W Incandescent, beaming compatible, Light Almond		N/A		JAS45612LAB	33.72
In-Wall 3-Way Decorator Style Dimmer Kit (includes 45612 + 45610 remote)		JAS45613	45.84	N/A	
In-Wall Switches		Part	Dealer	Part	Dealer
In-Wall Decorator Style Switch, 960W Incandescent or 15A Resistive, beaming compatible, White		JAS45609	34.91	JAS45609WB	31.22
In-Wall Decorator Style Switch, 960W Incandescent or 15A Resistive, beaming compatible, Lt Almond		N/A		JAS45609LAB	31.22
In-Wall 3-Way Decorator Style Switch Kit (includes 45609 + 45610 remote)		JAS45614	43.72	N/A	
Remotes for 3-Way Circuits		Part	Dealer	Part	Dealer
In-Wall Decorator Style 3-Way dimmer remote, White (use with 45609WB, 45609, 45612WB, 45612)		Use JAS45610WB	11.55	JAS45610WB	11.55
In-Wall Decorator Style 3-Way switch remote, Light Almond (use with 45609LAB, 45612LAB)		Use JAS45610LAB	11.55	JAS45610LAB	11.55

GE Brand in
GE retail packaging

Jasco Brand in
a plain box



GE Keypad
JAS45631

GE Keypad Controller

- Compatible with all Z-Wave certified lighting products
- Battery-powered
- Portable or wall-mount
- Control a light or group of lights
- Must be learned into an existing Z-Wave network via the primary remote



Z-Wave LCD Remote
JAS45633

- Both GE and Jasco branded products support the latest Z-Wave commands, including beaming
- Both brands are recommended for expanding a Z-Wave network that includes locks and 2-way battery devices
- Both product lines feature identical features
- The Jasco product line is less expensive because the packaging is a generic white box
- GE product features the instantly recognizable GE logo which is respected by consumers
- GE product is shipped in a clamshell package suitable for a retail environment
- All GE switches and dimmers are white, Jasco also offers light almond
- GE only allows the components for a 3-way circuit to be purchased as a kit. A JAS45610WB can be used with both GE and Jasco devices to create a hardwired 3-way.



Dimmer/Switch



Plug-in Devices



Outdoor Plug-In Module
JAS45604 or JAS45704



Receptacle

	Part	Dealer	Part	Dealer
Controlled Receptacle				
15A Decorator Style Duplex Receptacle, one controlled outlet	JAS45605	34.72	JAS45705	31.16
Wall-Mount Keypad				
Group/Scene Keypad Controller, wall-mount, battery powered	JAS45631	36.22	N/A	
Portable Remote Control				
Z-Wave LCD Remote with lock support (shipping third quarter)	JAS45633	45.09	N/A	
Plug In Modules				
Lamp Module, 300W Incandescent	JAS45602	35.78	JAS45602WB	31.54
15A Resistive, 960W Incandescent Appliance Module	JAS45603	34.04	JAS45603WB	29.66
Outdoor Plug-In Appliance Module, 960W Incandescent or 15A Resistive	JAS45604	36.16	JAS45704	32.47

Z-Wave Pool Control



INTPE653RC	Z-Wave Pool/Spa Controller Kit. Includes controller and remote.	360.65
INTPE953	Additional Remote Control for the PE653 Pool/Spa Controller	186.30
INTPA122	Water Sensor for the PE653 Pool/Spa Controller	43.60
INT178PA28A	Air Sensor for the PE653 Pool/Spa Controller	42.24
INTPE24VA	24-Volt Valve Actuator for the PE653 Pool/Spa Controller	76.55
INTP4243ME	24-Volt Valve/Pump Switch for the PE653 Pool/Spa Controller	769.52



Z-Wave Pool/Spa Controller:

- Control with the PE935 controller or Vera
- Call to confirm compatibility for other controllers
- Commands two-speed or variable speed pumps
- Add the water sensor for temperature control
- Add the air sensor for freeze protection

ASPIRE RF Climate Control

CWDRFTSTAT02	Multi-stage Thermostat	374.69
--------------	------------------------	--------

ASPIRE RF Occupancy Sensors

CWDRFOSW03	Battery-Powered Wall-Mount Occupancy Sensor	114.10
------------	---	--------

ASPIRE RF Plug-in Modules

CWDRFLDM	300W Lamp Module, beaming compatible	61.96
CWDRFAPM	600W Appliance Module, beaming compatible	56.07



RFTSTAT02

RFOSW03

RFLDM

RFTR9505-T

ASPIRE RF Scene Controller Keypad

CWDRFWC5**	Wall-Mount 5-Scene Controller, engraving is available	122.95
CWDRFWDK**	Engraved 5-button Kit	26.55

** AW- Alpine White, WS-White Satin, DS-Desert Sand, SG-Silver Granite

ASPIRE Software Solutions

CWDRFUSB-PRO	USB Installer Controller w/ CD	313.27
CWDRFUSB-PROX	USB Installer (No Software)	84.59

ASPIRE RF Communication Accessories

CWDRFTCP	System Controller, USB Stick and iPhone license	641.67
CWDRF232	RS232 ASCII Serial Interface	287.21

ASPIRE RF Garage Door Interface

CWDRFBGD	Garage Door Gateway Module, receives commands from the RFKGT or RFWGT and sends Z-Wave Commands	83.61
CWDRFUGR	Garage Door Opener Module, receives commands from the RFKGT or RFWGT and closes contacts to control a garage opener	46.73
CWDRFKGT	Garage Door Key Chain Remote Control, compatible with the RFBGD and RFUGR	41.80
CWDRFWGT	Battery-Powered Outdoor RF Pinpad compatible with the RFBGD and RFUGR	61.96

Cooper ASPIRE Screwless Wallplates

CWD9521**	ASPIRE 1-gang screwless wallplate	1.64
CWD9522**	ASPIRE 2-gang screwless wallplate	2.85
CWD9523**	ASPIRE 3-gang screwless wallplate	4.07
CWD9527**	ASPIRE Wallplate blank insert	1.45

** WS-White Satin, DS-Desert Sand, SG-Silver Granite

Matching Non-RF Cooper ASPIRE Devices and additional screwless wallplates are available. Please call for pricing.

ASPIRE RF Controllers

CWDRFHDCSG	Handheld Controller	184.43
CWDRFTDCSG	Table Top Controller	196.72

ASPIRE RF "No Neutral" Incandescent Dimmers

CWDRF9534**	600W Incandescent Dimmer, beaming compatible	78.69
CWDRF9536**	1000W Incandescent Dimmer, beaming compatible	95.91
CWDRF9542**	3-way non-RF remote with LEDs for "no-neutral" dimmers, beaming compatible	20.66

** AW- Alpine White, WS-White Satin, DS-Desert Sand

ASPIRE RF "Neutral Required" Dimmers

CWDRF9540-N**	600W Incandescent, LED, CFL, Magnetic, Electronic Low Voltage, or Fluorescent Dimmer, Neutral Required, with beaming	78.69
CWDRF9536-N**	1000W Incandescent or Magnetic Low Voltage Dimmer, Neutral Required, beaming compatible	95.91
CWDRF9537-N**	1000W Electronic Low Voltage or Fluorescent Dimmer, Neutral Required, beaming compatible	127.87
CWDRF9542-Z**	RF 3-way RF remote with LEDs for dimmers with a neutral, Neutral Required	56.57

** AW- Alpine White, WS-White Satin, DS-Desert Sand



CWDRFWC5

RFTDCSG

RFHDCSG

Dimmers

ASPIRE RF "Neutral Required" Switch

CWDRF9501**	15A Switch, Neutral Required, beaming compatible	86.07
CWDRF9517**	3-way RF remote for the RF9501 switch, Neutral Required, beaming compatible	56.57

** AW- Alpine White, WS-White Satin, DS-Desert Sand

ASPIRE RF "No Neutral" Incandescent Switch

CWDRF9518**	8A Incandescent Switch, beaming compatible	75.74
CWDRF9520**	3-way non-RF remote for the RF9518 switch	12.30

** AW- Alpine White, WS-White Satin, DS-Desert Sand

ASPIRE RF Battery Powered Transmitter

CWDRF9500**	Battery -Operated transmitter for switches or dimmers with wallplate	93.50
CWDRFBS22	Inner plate for RF9500 multi-gang installs	3.02

** AW- Alpine White, WS-White Satin, DS-Desert Sand

ASPIRE RF Receptacles

CWDRFTR9505-T**	Tamper Resistant 15A Split Control Duplex Receptacle, beaming compatible	98.36
-----------------	--	-------

** AW- Alpine White, WS-White Satin, DS-Desert Sand

Z-Wave Repeater Module

AEODSD37-ZWUS	Plug-in Z-Wave repeater with beaming support, use to extend Z-Wave networks	29.10
---------------	---	-------



DSD37-ZWUS



DSA22101-US



DSA03202W-US



**DSC56101-US
DSD31101-US**

Z-Wave Doorbell

AEODSC56101-US	Wireless doorbell with plug-in chime. Doorbell button to the chime unit is 315MHz. Chime unit can send, repeat and transmit Z-Wave. Choose between multiple chimes (being released in 2013).	TBD
----------------	--	-----

Z-Wave In-Line Load Control Modules

AEODSC10101-US	90-260VAC, 30A, Heavy-Duty Appliance switch with load monitoring, IP43 rated for outdoor applications	82.93
AEODSC53103-US	2 load switch module with load monitoring, 2nd generation, USB connector power	TBD

Window Darkening Film

AEODSC61	Retrofit Film for windows, turns opaque and transparent (being released in 2013)	TBD
----------	--	-----

Z-Wave Micro Energy Interfaces

AEODSC26103-US	Micro Switch module, 10A, 2nd generation	36.60
AEODSC18103-US	Micro Switch module, same as the DSC26103-US with load monitoring	39.09
AEODSC27103-US	Micro Dimming module, 300W, 2nd gen	36.60
AEODSC19103-ZWU	Micro Smart Dimming module with load monitoring, 300W, 2nd generation	39.09
AEODSC14101-US	Micro Motor Controller, 110-240 VAC	41.59
AEODSC35103-US	2 load switch module with load monitoring, 2nd generation, 110-240VAC power, (being released in 2013)	41.59

Micro Energy Touch Panels

AEOAL00**	Capacitive touch keypads for use with Micro Energy interfaces (**1,2 or 4 button, W=White or B=Black)	15.36
-----------	---	-------

Z-Wave PC USB Inclusion Controllers

AEODSA02203-US	Z-Stick, USB to Z-Wave inclusion controller, field upgradable, use with HomeSeer or MiCasaVerde as well as custom software	37.84
AEODSA07203-US	Remote Inclusion Z-Stick Lite USB interface	31.60



HSHSM100



HSHSM100	Multi-Sensor, senses motion, temperature, light level and reports battery level	64.70
HSZ-TROLLER	Z-Troller, Z-Wave serial interface for HomeSeer software or an automation controller, built-in signal monitor	140.51

Z-Wave Handheld Remote

AEODSA03202*-US	Minimote, 4-button scene controller, can be used as an inclusion controller or a primary remote, *B-Black or W-White	42.84
-----------------	--	-------

Z-Wave Keyfobs

AEODSA22101-US	Z-Wave keyfob, controls Z-Wave devices, including locks.	39.09
AEODSA38-US	Z-Wave panic button, controls Z-Wave devices, including locks.	39.09

Z-Wave Sounder

AEODSD31101-US	Wireless push button with plug-in 110dB sounder with battery backup. Push button to the sounder unit is 315MHz. Sounder unit can send, repeat and transmit Z-Wave. The button does not need to be installed. (Being released in 2013).	TBD
----------------	--	-----

Z-Wave Sensors



DSB04100-US



DSB05106-US



DSB05106-US

AEODSB04100-US	Door/window sensor, can be associated to up to 5 devices, powered by CR2 battery	39.09
AEODSB29101-US	2nd generation door/window sensor, can be associated to up to 5 devices, uses AAA (x2) batteries	39.09
AEODSB16	External sensor, accepts digital, analog, pulse or dry contact inputs; uses AAA (x2) batteries or power via a USB connector	44.21
AEODSB45-US	Water sensor, detects 1/32" of water	39.09
AEODSB05106-US	Indoor/Outdoor, four-in-one multi-sensor for motion, temperature, humidity and light	45.34

Z-Wave Plug-in Load Control Modules



DSC06106-US



**DSC24101-US
DSC25101-US**



DSC11101-US

AEODSC24101-US	15A Appliance module with load monitor	44.21
AEODSC25101-US	Lamp module with load monitoring	44.21
AEODSC06106-US	15A plug-in, relay, reports consumption in W or accumulated kWh	44.21
AEODSC11101-US	Z-Wave 15A power strip, 6 outlets, 4 controlled, reports consumption in W or accumulated kWh usage	83.06

Z-Wave Micro Smart Energy Interfaces

AEODSB09104-US	Whole house energy meter, reports wattage and kWh usage with power factoring and flow direction to a Z-Wave gateway	82.93
AEODSB28-US	Same as the DSB09104-US, 2nd generation with more accurate power factoring (being released in 2013)	82.93



Tech Tip: Confirm thermostat compatibility with your Z-Wave controller before ordering



SCHTZEMT400

Trane (sold through sister company Schlage for the Nexia system)

- Supports conventional single and multistage systems as well as heat pumps
- Supports dual fuel systems (Rh and Rc terminals)
- A 24VAC common connection is required



SCHTZEMT400BB3N	Trane Z-Wave thermostat, single, multistage, or heat pump, common required	120.97
-----------------	--	--------



HONYTH8320ZW100

Honeywell

- Supports conventional single and multistage systems as well as heat pumps
- Supports dual fuel systems (Rh and Rc terminals)
- A 24VAC common connection is required
- Remote control set points and mode
- Wi-Fi version also available, call for pricing



HONYTH8320ZW100	Honeywell Z-Wave thermostat, single, multistage, or heat pump, common required, includes a THP9045 wiring interface for 4 conductor installations	137.39
-----------------	---	--------



RCSTZ45

Residential Control Technologies

- Supports conventional single and multistage systems as well as heat pumps
- Supports dual fuel systems (Rh and Rc terminals)
- A 24VAC common connection is required
- Remote control of energy savings mode as well as set points and mode



RCSTZ45	RCS Z-Wave thermostat, single, multistage, or heat pump, common required	139.58
RCSRTS3	Flush remote temperature sensor for RCSTZ45 and EVOT-100R	23.42
RCSRTS4	Surface remote temperature sensor for RCSTZ45 and EVOT-100R	23.42



2GIG-Z-CT100

2GIG Technologies

- Touchscreen for easy control of HVAC
- Supports conventional single and multistage systems as well as heat pumps
- Supports dual fuel systems (Rh and Rc terminals)
- Can run off of 4x "AAA" batteries, a 24VAC common connection is not required
- Beaming compatible Z-Wave devices are required to ensure proper communication



2GIG-Z-CT100	2GIG Z-Wave thermostat, single, multistage, or heat pump, battery option	78.06
--------------	--	-------

FORTREZ Z

Z-Wave Controlled Water Valves



FRTWV01US075

- Professional grade, Z-Wave operated wireless water valve
- Motorized brass ball valve that can be commanded via Z-Wave to turn off the main water supply
- Comes in standard pipe sizes: 1/2", 3/4", 1", and 1 1/4"
- Certified to Z-wave v4.51
- Will qualify for insurance premium discounts for flood protection insurance. (Ask your insurance company for specific details)
- Two switches for manual operation

FRTWV01US075	3/4" motorized water valve, includes valve and wired water sensor. Use with WWA01AA or with a gateway to turn water off/on.	370.02
FRTWV01LFUS075	Same as above, NSF61G certified lead free	421.23
FRTWV01US100	1" motorized water valve, includes valve and wired water sensor. Use with WWA01AA or with a gateway to turn water off/on.	378.13
FRTWV01LFUS100	Same as above, NSF61G certified lead free	434.34

Water valves are also available in 1/2" and 1-1/4". Call for pricing.

Z-Wave Input / Output Module

FRTMIMOLITEUS	1 Input, 1 Form-C Z-Wave Module	67.13
---------------	---------------------------------	-------

Z-Wave Sounders



FRTSSA2US

FRTSSA-02

- 117dB sounder for auditory notification
- 5 LED's for visual notification
- LED's and sounder can be controlled via standard lighting level commands

FRTSSA3US

- Outdoor rated
- Built-in tamper switch



FRTSSA3US

FRTSSA*US	Z-Wave siren/strobe, 12VDC with 9V battery backup. Use with WWA-001 1 - Clear lens, 2 - Red lens	42.47
FRTSSA3US	High Output Outdoor Z-Wave Siren/strobe, 12VDC with 9V battery backup	68.88

Z-Wave Water Sensors

FRTWWA01AAUS*	Water/freeze sensor with 82db buzzer. Pair with a WV-01 to turn off water. Includes 2 AA batteries. *B-Black, W-White	47.77
FRTWWA02AAUS*	Water/freeze sensor with an LED. Pair with a WV-01 to turn off water. Includes 2 AA batteries. *B-Black, W-White	47.77



FRTMIMOLITEUS

- Input: 0 to 24VDC
- Output DPDT. 10A, momentary or latched
- 9-24VDC or 8-18VAC
- 3 3/8" x 2 1/2" x 1 1/4"



FRTWWA01AA

- Remote status monitoring and alerts when the detector is triggered
- Sounder or LED option

Vizia +™ Dimmers

vizia +[®]



LEVVP06-1L

LEVVP06-1LZ	600W incandescent dimmer, LED locator and brightness display	19.21
LEVVPM06-1LZ	600VA (450W) magnetic low voltage dimmer, LED locator and brightness display	37.13
LEVVPM10-1LZ	1000VA (800W) magnetic low voltage dimmer, LED locator and brightness display	46.80
LEVVPE04-1LZ	400W electronic low-voltage, LED locator and brightness display, neutral required	65.05
LEVVPE06-1LZ	600W electronic low-voltage, LED locator and brightness display, neutral required	102.48
LEVVPX10-1LZ	1000VA fluorescent dimmer for Mark 10 [®] Powerline or Tu-Wire [®] ballasts, LED locator and brightness display, neutral required	51.91
LEVVPX12-7LZ	1200VA-277VAC fluorescent dimmer for Mark 10 [®] Powerline or Tu-Wire [®] ballasts, LED locator and brightness display, neutral required	51.91
LEVVPH08-1LZ	8A fluorescent dimmer for Hi-lume [®] or Eco-10 [®] (Eco-Series) ballasts, LED locator and brightness display, neutral required	56.98
LEVVPH06-7LZ	6A-277VAC fluorescent dimmer for Hi-lume [®] or Eco-10 [®] (Eco-Series) ballasts, LED locator and brightness display, neutral required	102.48

White, Ivory, and Light Almond colors included - All dimmers are single pole or 3-way

Vizia + Fan Speed Control

LEVVPF01-1LZ	1.5A quiet fan speed control, LED locator, fan speed display	24.61
--------------	--	-------

White, Ivory, and Light Almond colors included. The fan is single pole or 3-way.

Vizia + Switch

LEVVPS15-1LZ	15A non-dimming electronic switch with LED locator; neutral required, single pole or 3-way, ivory and light almond included	16.46
--------------	---	-------

- When using Vizia RF +, consider non-communicating standard Vizia + devices for a consistent look
- Vizia + devices cover a wide range of electrical applications including electronic low voltage, multi-speed fan control, and dimming fluorescents
- Advanced programming options for energy savings, minimum brightness level, preset ON and OFF, fade rates, almost OFF and LED options

Vizia + 24 Hour Timer

LEVVP24-1PZ	120VAC, 60HZ, 1800W incandescent, 15A resistive/inductive, 1HP, for single pole, 3-way or more locations, with astronomic clock, backlit LCD display, green LED locator, neutral required. White assembled on device, ivory and light almond included.	33.12
-------------	--	-------

Vizia + Color Change Kits

LEVVPKIT-MD*	Matching dimmer color change kit: VPI06, VPM06, VPM10, VPE04, VPE06, VPX10, VPX12, VPH08, VPH06, VPF01, VP00R-1L	1.91
LEVVPKIT-CD*	Coordinating dimmer color change kit: VP00R-10	1.91
LEVVPKIT-MS*	Matching switch color change kit: VPS15, VP0SR-1L	1.91
LEVVPKIT-CS*	Coordinating switch color change kit: VP0SR-10	1.91

*W-White, I-Ivory, G-Gray, E-Black, B-Brown, R-Red, T-Light Almond



Which Would You Rather Have On Your Wall?

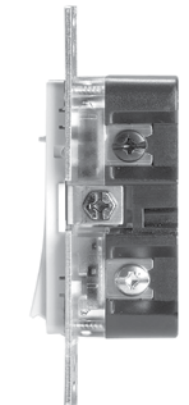

Slimmer profile for easier installation

Vizia + Coordinating and Matching Remotes for Multi-Location Control

LEVVP00R-10Z	Coordinating dimmer remote for 120VAC dimmers / fan speed control for 3-way or up to 10 locations, no led, neutral required except when used with incandescent or magnetic low voltage	15.09
LEVVP00R-1LZ	Matching dimmer remote for 120VAC dimmers / fan speed control for 3-way or up to 5 locations, with led locator and brightness / fan speed display, neutral required	17.67
LEVVP0SR-10Z	Coordinating switch remote for all 120VAC dimmers / fan speed control and VPS15-1L switch for 3-way or up to 10 locations, no led, neutral required	6.37
LEVVP0SR-1LZ	Matching switch remote for all 120VAC dimmers / fan speed control and VPS15-1L switch for 3-way or up to 5 locations, with led locator, neutral required	8.93
LEVVP00R-7LZ	Matching Dimmer Remote for 277VAC dimmers, 3-way or up to 5 locations, with LED locator and brightness, neutral required	17.67

White, Ivory, and Light Almond included

RadioRA 2

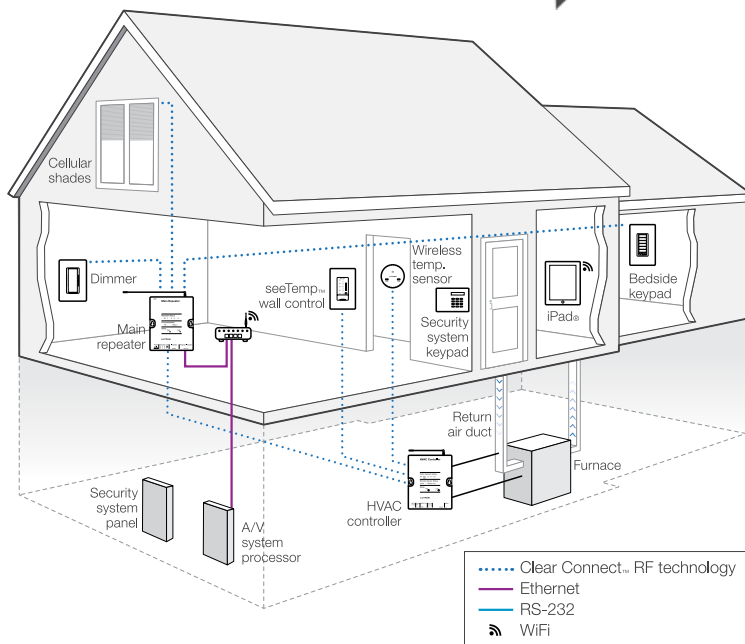

RadioRA 2 is a robust wireless home control system that provides convenient and intuitive control of lights, shades, temperature, and appliances in a single room or throughout an entire home. RadioRA 2 uses standard wiring topography familiar to any electrician, making it perfect for any new or retrofit installation. The system is scalable, programs quickly, and operates with ultimate reliability thanks to Lutron's Clear Connect™ RF Technology.

RadioRA 2 is one of the most exciting lighting systems to enter the automation marketplace. Clear Connect™ RF Technology allows systems to grow from a simple home theater application with a handful of devices to a complete 200 device automated home.



LURRD6DWH



LURRD6DSS



LURRD2ANFWH

Switches

LURRD8ANS*	RadioRA 2 8A neutral wire switch. All load types. Single pole or multi-location applications.	93.05
LURRD8SDV*	RadioRA 2 8A, 120/277V, 2-wire switch for incandescent, magnetic low voltage, and electronic low voltage	124.28
LURDRS*	RadioRA 2 remote switch for 120V 3-way applications	24.98

Gloss: WH-White, IV-Ivory, AL-Almond, LA-Light Almond, GR-Gray, BR-Brown, BL-Black
 Satin: HT-Hot, MR-Merlot, PL-Plum, TQ-Turquoise, TP-Taupe, ES-Eggshell, BI-Biscuit, SW-Snow, PD-Palladium, MN-Midnight, SI-Sienna, TC-Terracotta, GB-Greenbriar, BG-Bluestone, MS-Mocha Stone, GS-Goldstone, DS-Desert Stone, ST-Stone, LS-Limestone

See page 25 for color chips and samples

Dimmers		
LURRD6D*	RadioRA 2 600W Incandescent, magnetic low voltage, halogen dimmer. Two wire.	93.05
LURRD10D*	RadioRA 2 1000W Incandescent, magnetic low voltage, halogen dimmer. Single pole or multi-location.	124.28
LURRD10ND*	RadioRA 2 1000W Neutral wire, incandescent, magnetic low voltage, halogen dimmer. Single pole or multi-location. **LED and CFL Friendly**	124.28
LURRD6NA*	RadioRA 2 600W adaptive dimmer for incandescent, magnetic low voltage, and electronic low voltage. **LED and CFL Friendly**	124.28
LURRD2ANFWH*	RadioRA 2 2A fan speed controller	124.28
LURDRD*	RadioRA 2 remote dimmer for 120V 3-way applications	24.98
LURDRD277*	RadioRA 2 remote dimmer for 277V 3-way applications	37.47

**** LED and CFL Friendly****: refer below for details

LED Dimming Answers

Before you commit yourself or your customer to investing in LED technology you need to understand its limitations, especially when it comes to dimming control compatibility. There are over 4,000 manufacturers of LEDs in the world without a formal manufacturing standard. This makes it very difficult to engineer a dimmer for all of these devices.

Just because a fixture says it is dimmable, that does not mean it will perform well, due to the lack of a formal standard. These manufacturers may not indicate anything about performance; "dimmable" may only pertain to compatibility. This has resulted in dimmable products that do not work as claimed. Some of these issues are lights that never turn off completely, flicker, pop-on, or drop-off.

Visual deficiencies may not be the only problem. In-rush current can greatly damage a dimmer not suited for LEDs. In-rush current can be 10x the operating power of an LED and this occurs every half-cycle or times 120 times per second (60Hz). Simply put, this means 10 LED fixtures operating at 10W each can total 1000W, 120 times per second. The only way to know for sure if a particular LED lamp or fixture will work with a particular dimmer is to test it. Lutron has done extensive testing with many manufacturers and has performance report cards available to ensure exceptional results.

For full details regarding ****LED and CFL Friendly Dimmers**** contact Lutron: www.lutron.com/LED

For additional questions, please call Worthington 800-282-8864



Pico™ Wireless Keypads

- Utilizes Lutron's ultra-reliable Clear Connect™ RF technology
- Easily add a new or additional point of control without the need for new wires
- Use as a handheld control, car visor control, wall-mount, or tabletop control
- Available in 4-button configurations and 5 finish options
- Text and icon labeling options available for lighting and window treatments
- 10-year battery life
- Simple two-step programming



Clear Connect™ RF



LUPJ3BRLGW101

LURRD6DWH

LUPJ2BGWHT01	2-button Pico on/off with light text; white	15.61
LUPJ3BRLGWHI01	5-button Pico with raise lower light icons; white	15.61
LUPJ3BRLGWHT01	5-button Pico with raise lower light text; white	15.61
LUPJ3BRLGBLT01*	5-button Pico with raise lower light text black	15.61

Introduce Lighting Control for Under \$110

Pick any RadioRA 2 dimmer, switch, or plug-in, and add a Pico keypad. For under \$110 you have a perfect 3-way installation but also have planted a seed for lighting control. Your customer now has basic lighting control and these parts can be integrated to a whole house system. The initial devices of a progressive investment have been installed. No training required!

Starter Solution Packages



Plug-in lamp dimmer



5-button Pico



600W Dimmer

LURR1ZONEWWH	Wired Package. Includes (1) 600W dimmer, (1) 5-button Pico controller with raise lower, (1) adapter plate, (1) screwless wallplate	109.29
LURR1ZONELWH	Plug-in Package. Includes (1) 300w Plug-in lamp dimmer, (1) 5-button Pico controller with raise lower, (1) adapter plate, (1) screwless wallplate	109.29

3-Way, No Wires? No Problem!

The Pico wireless keypads can be used to control ANY Lutron RadioRA 2 switch, dimmer, or plug-in device. This allows for a simple way to place an auxiliary or remote switch anywhere in a home.

Programming only takes 12 seconds, easy and fundamental. Simply press and hold the on/off button on the dimmer for 6 seconds. Then press the "Off" button on the Pico controller for 6 seconds. That is it, you are done and your hands are the only programming tools required!

Pico Applications

Adjust lights from anywhere in a space with a Pico wireless controller. This versatile and easy-to-use control requires no wires and is compatible with a wide variety of Lutron lighting and automated window treatment solutions.

All Picos include double-side tape and bracket for these great application ideas:

- Under a granite countertop
- Behind a bed headboard
- Car visor
- Turn lights on when walking to your home at night
- At the bottom or top of the steps
- Lamp behind furniture (use a plug-in module)
- Any retrofit application



Single zone packages listed above, call for 2-zone package details



Actual Pico size shown

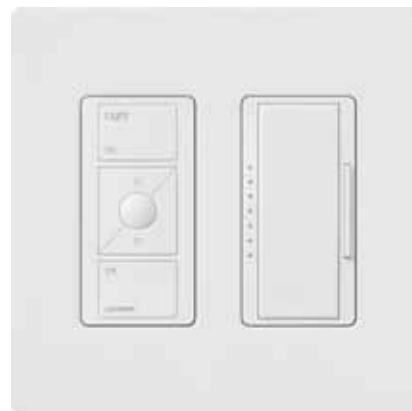

Picos fit in decorator style openings

Plug-In Modules



LURRD3LDSW



LURR3PD1SW



LURR15APS1SW

LURRD3LD*	RadioRA 2 tabletop lamp dimmer 300W incandescent and magnetic low voltage	93.05
LURR3PD1*	RadioRA 2 plug-in dimmer 300W incandescent and magnetic low voltage	93.05
LURR15APS1*	RadioRA 2 plug-in relay 15A/0.5 HP all load types	93.05

* Available in Satin SW-Snow or MN- Midnight

Pico Accessories



Pico with Car Visor Clip



Pico Pedestal Mounted



Pico Mounted with Wallplate Adapter

LULPED1*	Tabletop Pedestal Single Pico	15.61
LULPED2*	Tabletop Pedestal Dual Pico Keypads	18.74
LUPICOFFPADAPT	Pico Wallplate Adapter Kit	15.61
LUPICOCARVISOR	Pico Car Visor Adapter Kit	15.61
A11LV1	Single Gang Retrofit Low Voltage Bracket	0.89

* Available in Gloss WH-White or BL-Black

Lutron Ecosystem

To expand past single room controls, training is available for installers online and throughout the country. Training allows you to obtain the protected software which allows for whole house programming. The Lutron RadioRA 2 platform provides the foundation for an “Ecosystem” of automation. Lutron RadioRA 2 is not only lighting control but provides seamless solutions for thermostats, smart phones, occupancy sensors, garage doors, energy savings, shades, and security.

Basic Training Option

RadioRA 2 Level 1 Training

- Duration: 6-Hours self paced online or 1 day in-classroom
- Online or classroom certification, call for details
- System size: up to 100 devices
- Systems are designed and programmed using RadioRA 2 Essential Software

The RadioRA 2 Level 1 BLAST Training (Basic Lighting and Sales Training) is a live one day course or online self-paced module based course providing a solid foundation with the RadioRA 2 product family. The course starts by discussing the basics of lighting control and the market opportunities for the RadioRA 2 product family. It then proceeds to a discussion of all the parts and pieces that make up the RadioRA 2 system such as the Main Repeater, dimmers, and HVAC controls. The training concludes with a full demonstration of the Essentials software.



Software

Lutron Essentials is some of the finest lighting control software available today. The software follows a logical process of design, programming, and activation. It also allows installers to build a list price quote based on the system design. The software allows for third party integration and configuration of the Home Control+ App.

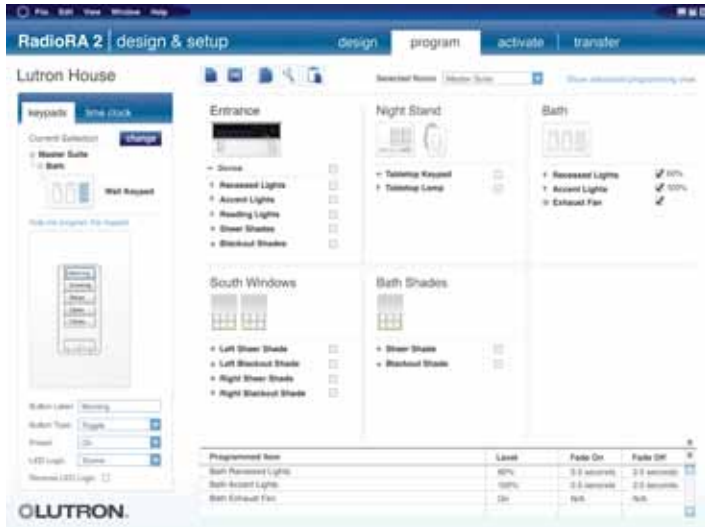

Lutron RadioRA 2 Programming Software

Home Control+ Application

The Home Control+ application can be purchased through iTunes for \$19.99 and is available for Android devices as well. Level 1 software is needed to configure the system to integrate with the application. It is very easy to set up and simply utilizes all of the programming you have done for the house. The application automatically configures itself to the existing setup. End users have full home control of lighting, HVAC, and time clock events.

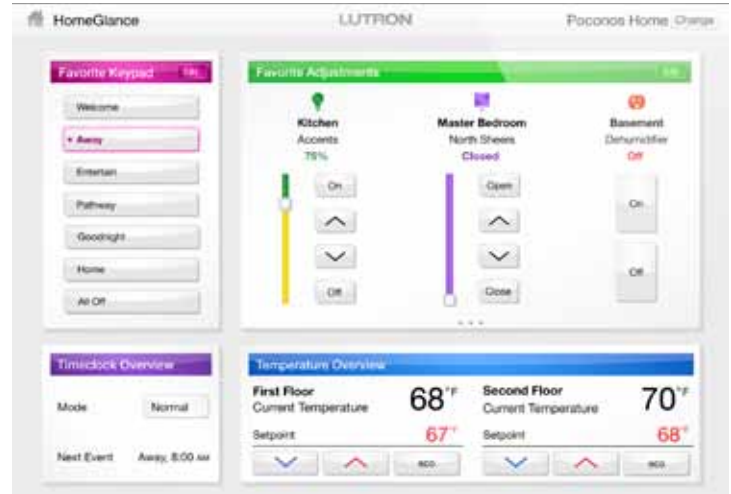

Lutron RadioRA 2 Home Control+ App

Foundation Packages

Foundation packages are a great way to save on cost as well and introduce a basic system that will grow into a whole home system. Choose the adaptive package for future proofing.

LURRFDNINCWH	RadioRA 2 Foundation Incandescent Package. Includes: LURRMAINREPWH (1), LURRD6DWH (3) LURDRDWH (1), LURRDH6BRLWH (1)	717.55
LURRFDNADAPTWH	RadioRA 2 Foundation Adaptive Package. Includes: LURRMAINREPWH (1), LURRD6NAWH (4), LURDRDWH (1), LURRDW6BRLWH (1)	930.51



Advanced Training Options

RadioRA 2 Level 2 Training - 2 Day

- Training requirement: 2-day training at Lutron Electronics Co., Inc.
- System size: up to 200 devices
- Systems are designed and programmed using RadioRA 2 Inclusive Software
- Advanced product and software training
- Hands-on design and programming workshop

Pre-requisites: Completion of the Level 1 Training (live or online).

RadioRA 2 Level 3 Training - 3 Day

- Training requirement: 3-day training at Lutron Electronics Co., Inc.
- System size: up to 200 devices
- The science of selling light and shade control
- System and keypad design methodology
- Project management
- Market expansion strategies

Pre-requisites: Completion of the Level 2 Training

Repeaters

RadioRA 2 uses a fixed repeater network to ensure a smooth, ultra-reliable, error-free lighting system. The core of any whole house RadioRA 2 installation starts with a main repeater. The main repeater uses wireless ClearConnect™ RF technology to talk to any RadioRA 2 device. The main repeater also incorporates a serial and Ethernet port for integration to third party automation systems as well as the MyLutron app.

Main and Auxiliary Repeaters

LURRMAINREPWH	RadioRA 2 Main Repeater	311.63
LURRAUXREPWH	RadioRA 2 Auxiliary Repeater	186.73



Wired and RF Configuration

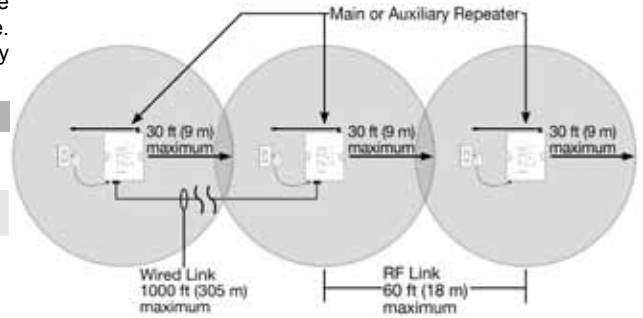

Lutron guarantees communication 30ft in any direction through any construction from a repeater; greater distances are common. To extend the size of a system simply use an Auxiliary Repeater. Up to 60ft from a main repeater, auxiliary repeaters are connected via a wireless RF link. For remote locations up to 1000ft away, simply use 18/2 and 22/2 shielded to hard-wire an auxiliary repeater for full control.

Level 1 certification needed for integration

Keypads

Lutron keypads are at the core of homeowner convenience and technical innovation. Keypads allow full home control or adjustment of lighting loads. Through the programming software, button and LED status can be configured for basic to whole-house scenes. Utilizing a keypad when integrating to a third party controller provides additional functionality such as arming or disarming a security system.

Keypad Types

Lutron RadioRA 2 keypads are composed of two families, standard wall mount and hybrid. A standard wall mount keypad requires nothing but 110VAC. The hybrid keypad is composed of a keypad and a 450W dimmer built into one device! This is great for retrofit applications where a single gang box is only available. They are also wonderful for new construction where wall clutter is a concern.

Button Kits

Do not be concerned about choosing the correct button kit. Lutron's innovative keypads have the same body and all button configurations are interchangeable within each family of keypad. Every keypad comes with a pack of premium clear stickers for temporary use until the homeowner becomes familiar with the system. Each keypad comes with a free engraving certificate to simply change the button configuration, color, and text.



LURRDW6BRLWH



LURRDW6BRLMN



LURRDW3BRLWH



LURRDH3BDSS



LURRDH6RLDWH



LURRDH6BRLDWH

Wall-Mounted Keypads

LURRDW7B*	RadioRA 2 wall-mounted keypad, 7-button	186.73
LURRDW6BRL*	RadioRA 2 wall-mounted keypad, 6-button with raise/lower	186.73
LURRDW5BRLIR*	RadioRA 2 wall-mounted keypad, 5-button with raise/lower and infrared receiving window on insert	186.73
LURRDW3BRL*	RadioRA 2 wall-mounted keypad, 3-button with raise/lower	186.73
LURRDW3BD*	RadioRA 2 wall-mounted keypad dual group, 3-buttons in each grouping	186.73
LURRDW2RLD*	RadioRA 2 wall-mounted keypad dual group, 3-buttons in top button grouping and 2 buttons with raise/lower bottom	186.73

Hybrid Keypads

LURRDH1RLD*	RadioRA 2 hybrid keypad 3-button, 2-button with raise/lower dual group and 450W dimmer	249.18
LURRDH2RLD*	RadioRA 2 hybrid keypad 2-button with raise/lower dual group and 450W dimmer.	249.18
LURRDH3BSRL*	RadioRA 2 hybrid keypad 3-button with raise/lower and 450W dimmer	249.18
LURRDH4S*	RadioRA 2 hybrid keypad 4-button and 450W dimmer	249.18
LURRDH5BRL*	RadioRA 2 hybrid keypad 5-button with raise/lower and 450W dimmer	249.18
LURRDH6BRL*	RadioRA 2 hybrid keypad 6-button with raise/lower and 450W dimmer	249.18

All keypads are available in 26 different colors see page 25

Radio Powr Savr™ Occupancy and Vacancy Sensors

Lutron occupancy sensors are another great solution for standalone applications. Any Lutron RadioRA 2 dimmer or switch can work with any of the following sensors. These sensors can be paired with any RadioRA 2 switch or dimmer just like a Pico controller using a simple two-step button push process.

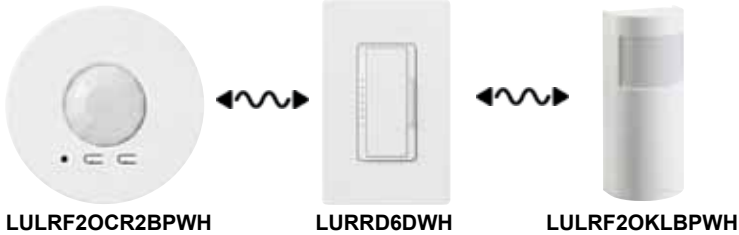

LULRF2OCR2BPWH	Ceiling occupancy/vacancy sensor; white	53.08
LULRF2VCR2BPWH	Ceiling vacancy only sensor; white	53.08
LULRF2OKLBPWH	Corner mount occupancy/vacancy sensor	53.08

Call for additional models

Car Visor Control

One of the most popular add-on sales for RadioRA systems has been the ability to control entry lighting from a car visor. With RadioRA 2, this is easily accomplished by adding a visor transmitter and a receiver. RadioRA 2 Visor Controls allow lights, shades / draperies, and other equipment to be controlled from the car with just a touch of a button on a Visor Control Transmitter or a HomeLink® compatible visor control.



LULR3BHSW	RadioRA 2 Car Visor Receiver	186.73
LURRVCRXWH	RadioRA 2 Car Visor Transmitter	30.60

Security and Integration

RadioRA 2 devices for interior lighting set to FULL ON

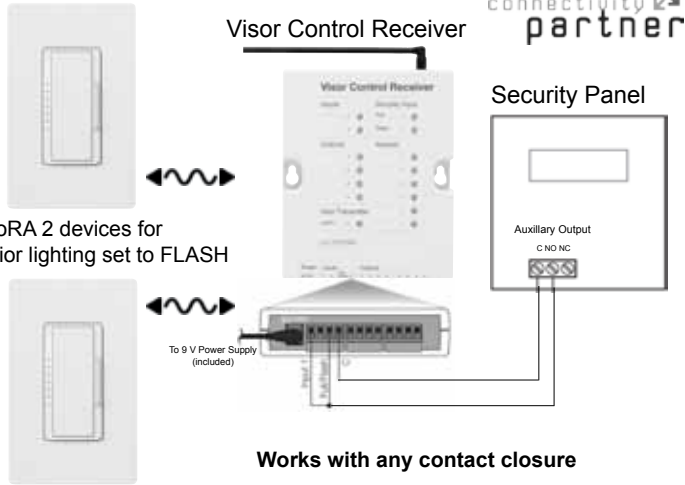

Works with any contact closure

RadioRA 2 is frequently interfaced with other systems within a home, such as security and fire alarm systems. Audible alarms are commonly utilized with these systems; however, the integration of lighting adds an enhanced level of security and peace of mind for the homeowner and their family. Simple programming allows an "ALL ON" feature to scare intruders while flashing exterior lights.

RadioRA 2 Integration Numbers

Device/Zone	Enable For Integration	Integration ID
Dining Room	✓	2
Dining Room - Left - Left Hybrid (RFID-MSL-WH)	✓	12
Dining Room - Left - Left Dimmer	✓	10
Dining Room - Left Side	✓	11
Dining Room - Right - Right Hybrid (RFID-MSL-WH)	✓	15
Dining Room - Right - Right Dimmer	✓	13
Dining Room - Right Side	✓	14
Dining Room - Slave Repeater (C) (RF-ALL-4-400-0H)	✓	1

When programming for HAI integration, simply note the integration ID numbers that are conveniently located in the Lutron Essentials software. Use these numbers as the address for each component in PC access and have full home automation control with one of the lighting industry's premier lighting systems.

Tabletop Keypads

LURRT5RL*	RadioRA 2 tabletop keypad - 5 buttons with raise/lower, corded or cordless capable via 2 AAA batteries	249.18
LURRT10RL*	RadioRA 2 tabletop keypad - 10 buttons with raise/lower, corded or cordless capable via 2 AAA batteries	280.40
LURRT15RL*	RadioRA 2 tabletop keypad - 15 buttons with raise/lower, corded or cordless capable via 2 AAA batteries	311.63

*-Satin: SW-Snow, MN-Midnight



HVAC Control

Lutron offers a number of solutions for controlling HVAC systems. The first method uses the TouchPro™ thermostat which wires directly to the HVAC system and links to RadioRA 2 through Clear Connect.™ The second employs a HVAC controller, wireless temperature sensor, and seeTemp™ decora style wall controller. A stylish hybrid of these two methods is to use the TouchPro™ and the seeTemp™ together. No matter which method is used all are controllable from Lutron's iPhone and iPad application.

LULRHVLVHVAC	RadioRA 2 TouchPro™ thermostat	281.02
LULRDWSTF*	RadioRA 2 seeTemp™ 110VAC wall controller, no HVAC wiring needed	124.28
LULRHVAC1WH	RadioRA 2 HVAC controller	217.95
LULRF2TWRBSW	RadioRA 2 wireless temperature sensor	74.94
LULRHVACPKGWH	RadioRA 2 HVAC package includes LULRDWSTFWH, LULRHVAC1WH, and LULRF2TWRBSW	374.08



LULRHVLVHVAC

LULRHVAC1WH

LULRDWSTFWH
LULRF2TWRBSW

Lutron provides wired relay outputs to control HVAC equipment.



Color Option Samples



With RadioRA 2 you have a large color pallet to choose from along with matching wallplates. Gloss options are traditional colors which work with nearly all other devices in the home. For applications where the customer is looking for that extra touch, look to the Satin Color™

choices. These custom colors allow wall devices to match the decor and room surfaces. The result will please even the most discerning tastes.

LUSCCK1	Sample Satin Color keychain	18.74
LUSCFD1	Sample Satin Color palette	6.24
LUDGCK1	Sample Designer Gloss keychain	18.74

RadioRA 2 Dimmer and Switch Color Change Kits

LURKD**/††	Dimmer color change kit	3.12
LURKD10**/††	Dimmer color change kit, 10-pack	24.98
LURKS**/††	Switch color change kit	3.12
LURKS10**/††	Switch color change kit, 10-pack	24.98
LURKAD**/††	Remote dimmer color change kit	3.12
LURKAD10**/††	Remote dimmer color change kit, 10-pack	24.98
LURKAS**/††	Remote switch color change kit	3.12
LURKAS10**/††	Remote switch color change kit, 10-pack	24.98



LUSCR15HFDUBG



LUSCAR15HFDUSS

Dimmable Outlet Solution

LUCAR15HFDU*	Electrical outlet designed for use with a Lutron dimmer. Half designed for dimming use. Use with a LURP-FDU-10 plug. Gloss	18.11
LUSCR15HFDU*	Same as the LUCAR15HFDU - Satin	20.61
LURPFDU10**	Dimmable Lamp Plug for use with the LUCAR15HFDU (**WH-White, BR-Brown)	12.49

Power Modules and Synthetic Loads

LUPHPMPA120WH	Phase-adaptive power module 120V 16A	206.08
LUPHPMPADVWH	Phase-adaptive power module 120-277V 16A	287.27
LUPHPMSWDVWH	Switching power module 120-277V 16A	156.12
LULUTLBXWH	Synthetic minimum load. Used when a dimmer or switch's minimum load cannot be met.	93.68
LULUTLBXCEWH	Synthetic minimum load. 240V Input.	93.68



LUCWBI

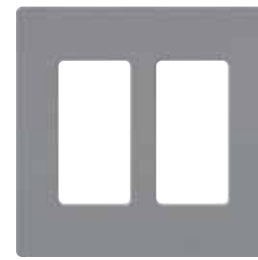

LUCW2GR



LUSC1MN

Claro Designer Gloss Wallplates

LUCW1††	Claro 1-gang screwless wallplate	3.06
LUCW2††	Claro 2-gang screwless wallplate	6.12
LUCW3††	Claro 3-gang screwless wallplate	9.37
LUCW4††	Claro 4-gang screwless wallplate	12.49
LUCW5††	Claro 5-gang screwless wallplate	31.22
LUCW6††	Claro 6-gang screwless wallplate	43.72

Satin Wallplates

LUSC1**	Satin 1-gang screwless wallplate	5.62
LUSC2**	Satin 2-gang screwless wallplate	8.74
LUSC3**	Satin 3-gang screwless wallplate	11.87
LUSC4**	Satin 4-gang screwless wallplate	14.99
LUSC5**	Satin 5-gang screwless wallplate	14.99
LUSC6**	Satin 6-gang screwless wallplate	14.99

Stainless Steel Wallplates

LUCW1SS	Claro 1-gang screwless stainless steel wallplate	6.87
LUCW2SS	Claro 2-gang screwless stainless steel wallplate	12.80
LUCW3SS	Claro 3-gang screwless stainless steel wallplate	18.74
LUCW4SS	Claro 4-gang screwless stainless steel wallplate	24.98

††-Gloss: WH-White, IV-Ivory, AL-Almond, LA-Light Almond, GR-Gray, BR-Brown, BL-Black

**-Satin: HT-Hot, MR-Merlot, PL-Plum, TQ-Turquoise, TP-Taupe, ES-Eggshell, BI-Biscuit, SW-Snow, PD-Palladium, MN-Midnight, SI-Sienna, TC-Terracotta, GB-Greenbriar, BG-Bluestone, MS-Mocha Stone, GS-Goldstone, DS-Desert Stone, ST-Stone, LS-Limestone

Ivalo Finiré LED Fixtures

Finiré eliminates guesswork by ensuring 100% compatibility between LED fixtures, drivers, and controls. This complete solution combines an architectural grade fixture with a high-performance Hi-lume® LED driver designed to work with Lutron RadioRA® 2, HomeWorks® QS, and GRAFIK Eye® QS control systems.



Call for pricing details!

Finiré Downlight

GRAFIK Eye QS

For an easy and efficient way to control both electric light and daylight, look to GRAFIK Eye QS. Fully customizable, GRAFIK Eye QS adjusts lights and shades for any task or activity at the touch of a button. You'll save energy while meeting the aesthetic, functional, and regulatory needs of any project or space.



LUQSGRJ6PTWH



LUQSGRJ6PWH

For other color options visit Lutron.com

LUQSGRJ4PWH	4-zone GRAFIK Eye QS, white cover	693.20
LUQSGRJ4PTWH	4-zone GRAFIK Eye QS, translucent cover	693.20
LUQSGRJ6PWH	6-zone GRAFIK Eye QS, white cover	793.12
LUQSGRJ6PTWH	6-zone GRAFIK Eye QS, translucent cover	793.12

Sivoia® QS Wireless

Sivoia QS Wireless insulating honeycomb shades represent an evolution in Lutron window treatment operation, as they are the first wire-free, battery-powered shading solution. Sivoia® QS Wireless insulating honeycomb shades offer incredible value at an affordable price, backed by the quality of the Lutron brand. With its honeycomb design and extensive fabric offering, this window covering provides a crisp clean look to enhance any décor.



The Opportunity and Market

- \$4 Billion Industry
- 100 Million Existing Homes
- Excellent for wireless retrofit
- Perfect for new hard-wired installations
- Easy way to increase revenue
- Scalable for any application

Are you making window treatments part of your installation?



Uses Lutron's Clear Connect™ Technology

Lutron honeycomb shades offer a simple scalable way to offer precision natural light control. If you are installing a dimmer to control artificial light, why not control natural light? There are approximately 500,000 new homes built every year compared to over 100 million existing homes. This can be a perfect lead-in to call back existing clients for retrofit applications.

Applications



Lutron honeycomb insulating shades are perfect for these applications and more!

- Hard-to-reach windows
- Any retrofit where pulling wire is difficult
- Stairwell windows
- Glass or French doors
- Windows behind a bathtub
- Commercial offices
- Whole house residential
- Home theaters
- Every RadioRA 2 installation



Triathlon Power Technology

Ultra Efficient Standby Power

1/1000W in standby mode, 1W is considered "Green"

Alkaline Battery Power

3 to 5 year battery life with standard "D" or "AA" dependent on window size. This is based on two up and two down movements a day!

Hybrid Drive Design

Shade design utilizes potential energy coupled with ultra-efficient motors



Call for details on hardwired options

Insulating Value



Honeycomb shades are cellular, meaning they have fabric on the front and back to create air pockets. These innovative air pockets trap heat to provide superior insulation. These shades can double the R-Value of most windows!

save energy with Lutron™

Programming

For a standalone installation with a honeycomb shade and Pico wireless controller, simply follow these two steps:

1. Press the shade programming button
2. Press the "Lower" button on the Pico Control

It is just that easy to program! No messy cables or tricks needed. Incorporating multiple shades or Pico controllers is just as simple.

If you are certified RadioRA 2 installer, simply use the Essentials or Inclusive software to program the shades into any lighting scene.

Battery Replacement

Battery replacement is easy!

Lutron's exclusive Tap n' Tilt technology allows almost anyone to change batteries every 3-5 years.

To clean, simply use a feather duster or a vacuum with a brush attachment.



Simply press the release buttons, allowing the headrail to tilt forward;

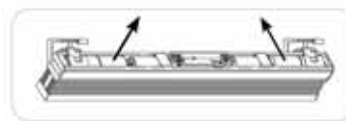

Change the batteries...



And snap the headrail back in place.

Easy Installation

Installing a honeycomb shade is very easy and requires just a drill and tape measure. First mark the bracket location and pre-drill. Then attach the shade brackets using the supplied hardware. Install the shade in the brackets by simply pressing it into the brackets.

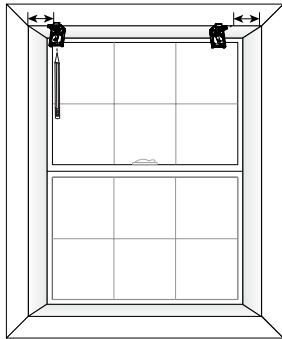

Measure and Pre-Drill

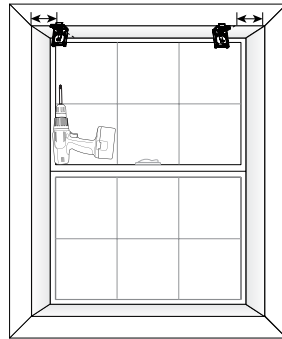

Attach Brackets

Hook Front Edge

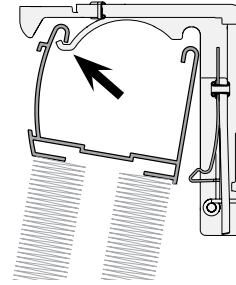

Side View

Press Shade

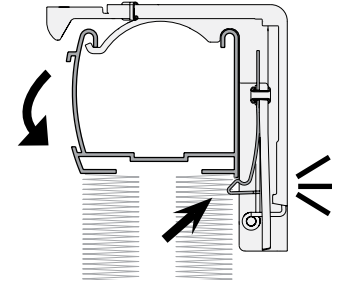

Click Into Place

First Installation Testimonial

We spoke with Dave Mitylmg of Mitylmg Electric and Refrigeration, an industry veteran of over 30 years. "I spent more time reading the directions for what I was supposed to do than actually installing the shades. It only took 10 minutes and my wife just loves them!"

Shade Configuration Tool

Do you feel that keeping track of measurements, fabric styles, and mounting options is difficult? After becoming a certified shade installer, you gain access to Lutron's Shade Configuration Tool, or SCT. This allows you to quote jobs based on protected list pricing with all fabric types and measurements. Easily edit existing quotes for a simple way to show a customer what other options are available, right at your fingertips.

Window Treatments for \$285

Honeycomb shades are very economically priced and the Shade Configuration Tool allows you to make pricing adjustments with a keystroke.

A 3'x5' battery-operated honeycomb shade with pointed bonded fabric can cost as little as \$285. List price on this type of shade is \$450. With list pricing provided by the software, you are sure to stay aligned with the shade market.

Certification Requirements

Certification to install honeycomb insulating shades is online and very simple.

- Step 1: Register with www.lutron.learn.com
- Step 2: Complete online training
- Step 3: Purchase a Honeycomb demonstration kit and binder.

**Want to install other Lutron shading solutions?
Give us a call to learn how to get involved!
Worthington Distribution 1-800-282-8864**



Demonstration Equipment

The Lutron Honeycomb shade demonstration unit is truly one of the finest pieces of demonstration equipment in the industry. It is a fully operational honeycomb shade accompanied with a tabletop Pico controller. The shade is mounted within a stand-up tabletop window frame that easily collapses into a 8"x8"x36" black carrying case embroidered with the Lutron logo. Because the shade is battery-operated, it allows a simple demonstration anywhere, from your customer's kitchen table to a trade show booth.



LUCELLULARBIND

Purchase the demo equipment from Worthington and receive \$50 off your first shade order!

LUCELLULARDEMO	Portable tabletop honeycomb demonstration shade with Pico controller	499.00
LUCELLULARBIND	Complete fabric sample binder. Real fabric samples, all colors and styles included	93.68



LUCELLULARDEMO

PulseWorx is the most reliable lighting control system that utilizes only existing wiring, developed for use in residential and light commercial applications, and is ideal for both retrofit and new construction.

What is Universal Powerline Bus?

Universal Powerline Bus (UPB™) is a highly reliable, cost-effective, 2-way communications technology which enables control products to utilize existing powerlines for both residential and commercial applications. The award-winning UPB™ technology was developed by Powerline Control System (PCS) and has been awarded several patents for its innovation.



Wall Switch Modules

Standard Switch/Dimmers for Incandescent, Fluorescent, Inductive and Magnetic Low Voltage Devices

PCSWS1D-6*	600 watt / 5 amp UPB wall switch/dimmer	74.69
PCSWS1D-10*	1000 watt / 8 amp UPB wall switch/dimmer	87.55
PCSWS1D-15*	1500 watt UPB wall switch, single or 3-way, dimmer or switch (+ see note)	180.27
PCSWS1D-24*	2400 watt UPB wall switch, single or 3-way, dimmer or switch (+ see note)	231.76

+Don't forget to order the matching wall plate when you order the high wattage Dimmers (1500, 2400)

Switch/Dimmers that will also control CFL/LED lights

PCSWS1DL-6-*	600 watt/ 5 amp UPB wall switch/dimmer for LED or CFL	99.92
PCSWS1DL-10-*	1000 watt/ 8 amp UPB wall switch/dimmer for LED or CFL	112.78
PCSWS1DL-15-*	1500 watt UPB wall switch, single or 3-way, dimmer or switch (+ see note)	205.50
PCSWS1DL-24-*	2400 watt UPB wall switch, single or 3-way, dimmer or switch (+ see note)	256.99

+Don't forget to order the matching wall plate when you order the high wattage Dimmers (1500, 2400)

Switch/Dimmers that will control Electronic Low Voltage Loads

PCSWS1E-3*	Electronic low voltage 300VA UPB wall switch, single or 3-way, dimmer/switch	149.88
PCSWS1E-5*	Electronic low voltage 500VA UPB wall switch, single or 3-way, dimmer/switch	179.86



PCSWS1D-10*



PCSWS1D-15*
PCSWS1D-24*



PCSWS1DL-6-*



PCSWS1DL-10-*

Keypads and Auxiliary Switch

PCSRWS-*	UPB remote switch for above devices (for 3- and 4-way applications)	30.90
PCSKPCW-6-*	Wall-mounted 6-button keypad, bright/dim and IR receiver (requires neutral)	138.89
PCSKPCW-8-*	Wall-mounted 8-button keypad, each button is programmable (requires neutral)	138.89
PCSKPLD-6-*	Wall-mounted 6-button keypad with 400 watt load control, bright/dim and IR receiver (requires neutral)	184.85
PCSKPLD-8-*	Wall-mounted 8-button keypad with 400 watt load control, each button is programmable (requires neutral)	184.85
PCSKPLR-6-*	Wall-mounted 6-button keypad with 10 amp relay, bright/dim and IR receiver (requires neutral)	184.85
PCSKPLR-8-*	Wall-mounted 8-button keypad with 10 amp relay; each button is programmable (requires neutral)	184.85

*Specify W-White, I-Ivory, A-Almond (LA-Light Almond, B-Black, G-Gray, BR-Brown are special order)

Plug-In Modules

PCSLM1-4	Lamp Module, 1 channel, 400 watt	64.95
PCSLM2-8	Lamp Module, 2 channel, 800 watt, 2 controlled, 2 continuous outlets	119.90
PCSAM1-12	Appliance Module, 1 channel, 12 amp	64.95
PCSPIMR	UPB Powerline Serial Interface Module	89.93
PCSPIMU	UPB Powerline Interface Module-USB	99.92
PCSOCM	Output Control Module, 2 controlled relays	99.92
PCSICM	Input Module, 2 dry contact inputs	99.92
PCSDBM	Door Bell Module, wired in the doorbell circuit	99.92
PCSTCM	Telephone Control Module, detects ring	99.92
PCSTEC	Timed Event Controller, 20 timed events	149.88
PCSNDS-1111-PW	Network Device Server, use UPStart with a PIM-R over the Internet	298.76



PCSICM



PCSTCM



PCSPIMR



PCSLM2-8

Couplers, Repeaters, and Filters

PCSSPR-1	Split-phase Repeater, HAI Compatible	224.82	PCSPLF-15	Plug-In 15 amp Filter	174.86
PCSTPR-120	3-Phase Repeater, HAI Compatible	324.74	PCSPLF-5	Plug-in 5 amp Filter	79.94
PCSPPC-1	Passive hardwired UPB Phase Coupler	49.96	PCSHLF-20	Powerline Wire-in Filter, 20 amps	236.81
PCSSPR-3	Plug-in Split-phase Repeater, HAI Compatible	224.82	PCSILC	In-Line Choke Filter	14.99

Mi LightStyle Control Solutions

Mi LightStyle is the most flexible and affordable standalone home automation controller solution for PulseWorx or any UPB technology based system. Integrating iPhone, iPad, Android, etc. control has become a necessity, and whether you are a home automation, audio/video or security integrator. Even electricians will enjoy how quickly and easily PulseWorx devices can be configured through Mi LightStyle.



PCSMLS4SK	Mi LightStyle 4-zone starter kit (1) MLS1024-IR, (1) PIP, (1) KPLD-6, (3) WS1D-6, (1) PPC-1	839.37
PCSMLS-4U	Mi LightStyle and Powerline Interface Power Pack with 1024 nodes and IR input	299.76

Devices allow you to create advanced timers, triggers and events based on the status of your devices, time of day, even weather conditions. 1024 series extends the capabilities of Mi LightStyle for extremely large installations.

It also includes a batch feature which allows you to do all the PulseWorx programming before committing the changes to devices. IR series allows you to program your infrared universal remote to control all your PulseWorx UPB devices and scenes.

Control Solution Kits

PCSRCK-2	Remote Car Kit allows control of lights from your car. No batteries to worry about. Includes: (1) wireless transmitter, (1) wireless receiver and (2) 600 watt dimmer/switches	352.52
PCSSIK-4	Security Interface Kit allows any security or automation panel which transmits X-10 to communicate directly to UPB devices. Includes (1) X10 to UPB bridge, (4) 600 watt dimmer/switches and (1) Plug-in Phase Coupler.	435.70



Simple Powerline Communication Lighting Control



Are you looking for a simple-to-set-up lighting control like the X10 systems of the past? No PC or programmer required...ever. A simple button push to learn the device in. You can have one-to-one and one-to-many control.

SimpleWorx is powered by SPC™ (Simple Powerline Communication), a rock solid technology that makes a lot of sense, while offering efficient solutions for remotely turning lights on and off.

SPC provides super reliable one-way control of lights and appliances using the 120v wiring that is already in place and offers significant benefits above older powerline technologies or traditional wired and RF solutions.

Transmitter Modules

PCSSWX-DAT	Digital Astronomical Timer, 4-event Clock	109.91
PCSSWX-KPT4	Keypad Transmitter, Wall Mount, 4-button	59.95
PCSSWX-DKT4	Desktop Keypad Transmitter, 4-button	89.93
PCSSWXWSTAC10*	Wall Switch Transmitter - 120V input w/10A General Load, 800W Incandescent	54.96
PCSSWXWSTAC20*	Wall Switch Transmitter - 120V input w/20A MAX Load	74.94
PCSSWX-DST-AC-*	Desktop Switch Transmitter	74.94
PCSSWXDSTAC10W	Desktop Switch Transmitter - 120V input w/10A General Load, 800W Incandescent, White	74.94
PCSSWX-FMT-AC	Fixture Module Transmitter - 120V input	59.95
PCSSWX-FMT-CC	Fixture Module Transmitter - Contact Closure input	59.95
PCSSWX-FPT-AC	FlatPac Transmitter - 120V input	74.94
PCSSWX-FPT-CC	FlatPac Transmitter - Contact Closure Input	74.94
PCSSWX-PMT-CC	Plug-In Module Transmitter - Contact Closure Input	84.93

*Specify W-White, I-Ivory, A-Almond (LA-Light Almond, B-Black, G-Gray, BR-Brown are special order)



PCSSWX-DAT



PCSSWX-KPT4

Receiver Modules

PCSSWXWSRAC10*	Wall Switch Relay - 120V output 10A General Load, 800 watt Incandescent	55.96
PCSSWXWSRAC20*	Wall Switch Relay - 120V output 20A MAX load	59.95
PCSSWXDSRAC10*	Desktop Switch Relay- 120V output, 10A General Load, 800 watt Incandescent, White	79.94
PCSSWX-FMR-AC	Fixture Module Relay - 120V output, 20A MAX load	59.95
PCSSWX-FPR-AC	FlatPac Relay - 120V output, 20A MAX load	74.94
PCSSWX-PMR-AC	Plug-In Module Relay - 120V output, 15A MAX load	49.96
PCSSWX-PMR-CC	Plug-In Module Receiver - Contact Closure, 8A MAX load	74.94
PCSSWX-RWS*	Remote Wall Switch - Standard - Red LED	30.90

*Specify W-White, I-Ivory, A-Almond (LA-Light Almond, B-Black, G-Gray, BR-Brown are special order)



PCSSWX-WSR-AC10*



PCSSWX-FMR-AC

Complete Dimmer/Switch (Requires Neutral) - White

SAUS11-40-W	UPB Wall Switch, single or 3-way, dimming or switching, 900 watt	74.95
SAUS28BTP-W	UPB 8-button 'Bar Style' Switch/keypad, single or 3-way, dimming or switching, 900 watt	119.95
SAUS28OTP-W	UPB 8-button 'Oval Style' Switch/keypad, single or 3-way, dimming or switching, 900 watt	119.95
SAUCQT-40-W	UPB 4-button 'Oval Style' Scene Controller keypad w/ 4 status LED (no local circuit output)	99.95
SAUSR1-40A-W	Complete Remote Switch (for 3- and 4-way applications)	32.95

- Reliable UPB powerline communication
- Unique dimmer base design
- Keypads can control one or two loads
- Interchangeable faceplates allow the dealer to customize the button layout based on the customer's needs

Controller-Style Faceplates

For use with SAUS240, SAUS22-40 bases

SAZS24B-*	Quad 'Thin Bar' button faceplate	14.95
SAZS26B-*	Quad 'Thin Bar' button with 2 rocker faceplate	24.95
SAZS28B-*	Eight 'Thin Bar' button faceplate	24.95
SAZS24O-*	Quad 'Oval' button faceplate	14.95
SAZS25O-*	Quad 'Oval' button with 1 rocker faceplate	19.95
SAZS26O-*	Quad 'Oval' button with 2 rocker faceplate	24.95
SAZS28O-*	Eight 'Oval' button faceplate	24.95
SAZS24BS-*	Quad 'Thin Bar' button faceplate for SAUCQT-40	24.95
SAZS24OS-*	Quad 'Oval' button faceplate, for SAUCQT-40	24.95

* = Specify W-White, A-Almond, LA-Light Almond, I-Ivory, BK-Black, BN-Brown

Communication Control

SAUCS-01	UPB Controller, Scheduler, RS232	159.95
SAUMC-DB9-W	Plug-in Serial-UPB Power Line Interface Module, serial cable included - White	94.95
SAUMC-USB-W	Plug-in USB to UPB Power Line Interface Module, USB cable included - White	94.95
SAUTR	UPB hard-wired Coupler/Repeater/PIM for 3-phase, serial DB-9 cable included	379.95

Universal Dimmer/Controller Bases

SAUS2-40	900 watt switch/dimmer base. Add faceplate.	79.95
SAUS22-40	550 watt x2 switch/dimmer base. Add faceplate.	179.95
SAUS1-40	900 watt switch/dimmer base. Add faceplate.	71.50
SAUCQT-40	Scene controller base. Add ZS24BS or ZS24OS four button/LED faceplate.	74.95
SAUS28OTP-*	Plug-in 8 oval button tabletop controller (* Specify W-White, BK-Black)	119.95
SAZTP2*	Tabletop base & cord, accepts US240 base & faceplate (* Specify W-White, BK-Black)	24.95
SAUS2TP-*	Plug-in universal tabletop controller US240 base. Add faceplate.	94.95
SAUSQT-*	Plug-in 4 oval button tabletop controller with 4 status LEDs (* W-White or BK-Black)	124.95

Prices shown are Minimum Advertised Prices
Log in or call for actual dealer price

Remote Switch (for 3- and 4-way applications)

SAUSR-40A	Remote Switch Base with dual blue/green LEDs (for 3-and 4-way applications)	24.95
-----------	---	-------

Rocker Style Faceplates

SAZS11-*	Single Rocker faceplate	4.45
SAZS12-*	Dual 'Tall' Rocker faceplate, for use with SAUS240, SAUS22-40 and SAUSR-40A bases	13.95
SAZS22-*	Dual 'Short' Rocker faceplate	13.95
SAZS23-*	Triple Rocker faceplate	19.95
SAZS24-*	Quad Rocker faceplate	24.95

* = Specify W-White, A-Almond, LA-Light Almond, I-Ivory, BK-Black, BN-Brown

Coupling and Repeating

SAZPCI-W	Inverted Coupler-Passive, wires to 220 VAC circuit	69.95
SAZPCI-B	Inverted Coupler-Passive breaker mount, Compatible: Cutler-Hammer, Square D, Murray	69.95
SAZPCI-P30A	Inverted Coupler - Plugs into a 30 amp, 220 VAC outlet (NEMA 10-30 configuration)	79.95
SAZPCI-P50A	Inverted Coupler - Plugs into a 50 amp, 220 VAC outlet (NEMA 10-50 configuration)	79.95

Load Control Modules

SAUML-E-W	2-Prong, plug-in, 300 watt UPB Lamp Module with local sensing - White	64.95
SAUML-20-W	3-Prong, plug-in, 400 watt UPB Lamp Module with local sensing, count-down timer and pass through outlet - White	74.95
SAUMA-E-W	2-Prong, plug-in 12 amp UPB Appliance Module - White	64.95
SAUMA-20-W	3-Prong, plug-in 15 amp UPB Appliance Module with local sensing, count-down timer and pass through outlet - White	74.95
SAUMI-32-W	Plug-in UPB I/O module, 3 input (4-5V AC/DC, 2 closure, 1 audio), 2 output (60V AC/DC) - White	94.95
SAUFR-30	UPB In-line 12 amp Fixture Relay Module, built in count-down timers - White	84.95
SAUFD-30	UPB In-line 300 watt Fixture Dimming Module, built in count-down timers - White	84.95
SAURD-30-*	UPB top controlled outlet, 12 amp, bottom on, built in count-down timers (* Specify W-White, A-Almond, I-Ivory, LA-Light Almond)	94.95

Noise Filtering and Isolation

SAZNF10A-P	Plug-in 10 amp, blocks noise above 4 kHz	32.85	SAZNF10A-W	Wire-in 10 amp, blocks noise above 4 kHz	24.95
------------	--	-------	------------	--	-------

Decora Wallplates

	White	Ivory	Light Almond	Ebony/Black	Brown	
	LEV80401-W	LEV80401-I	LEV80401-T	LEV80401-E	LEV80401	0.37
	LEV80409-W	LEV80409-I	LEV80409-T	LEV80409-E	LEV80409	0.76
	LEV80411-W	LEV80411-I	LEV80411-T	LEV80411-E	LEV80411	1.15
	LEV80412-W	LEV80412-I	LEV80412-T	LEV80412-E	LEV80412	4.68
	LEV80423-W	LEV80423-I	LEV80423-T	LEV80423-E	LEV80423	7.77
	LEV80436-W	LEV80436-I	LEV80436-T	LEV80436-E	LEV80436	9.74
	LEV80405-W	LEV80405-I	LEV80405-T	LEV80405-E	LEV80405	0.76
	LEV80421-W	LEV80421-I	LEV80421-T	LEV80421-E	LEV80421	2.29
	LEV80431-W	LEV80431-I	LEV80431-T	LEV80431-E	LEV80431	4.50

Decora Plus Screwless Wallplates

	LEV80301-SW	LEV80301-SI	LEV80301-ST	LEV80301-SE	LEV80301-SO	4.52
	LEV80309-SW	LEV80309-SI	LEV80309-ST	LEV80309-SE	LEV80309-SO	9.04
	LEV80311-SW	LEV80311-SI	LEV80311-ST	LEV80311-SE	LEV80311-SO	13.58
	LEV80312-SW	LEV80312-SI	LEV80312-ST	LEV80312-SE	LEV80312-SO	18.10

Decora Nylon Wallplates

	LEV80401-NW	LEV80401-NI	LEV80401-NT	LEV80401-NE	LEV80401-N0	0.47
	LEV80409-NW	LEV80409-NI	LEV80409-NT	LEV80409-NE	LEV80409-N0	0.95
	LEV80411-NW	LEV80411-NI	LEV80411-NT	N/A	LEV80411-N0	1.44
	LEV80412-NW	LEV80412-NI	LEV80412-NT	N/A	LEV80412-N0	4.73

Standard Wallplates

	LEV80701-W	LEV80701-I	LEV80701-T	LEV80701-E	LEV80701	0.27
	LEV80709-W	LEV80709-I	LEV80709-T	LEV80709-E	LEV80709	0.56
	LEV80703-W	LEV80703-I	LEV80703-T	LEV80703-E	LEV80703	0.27
	LEV80705-W	LEV80705-I	LEV80705-T	LEV80705-E	LEV80705	0.60
	LEV80414-W	LEV80414-I	LEV80414-T	LEV80414-E	LEV80414	2.46
	LEV88033	3-gang box mount blank plate for the 3-gang repeater box-White only				2.79

Give us a call about wallplate configurations that are not listed above

Studio Series Decorator Wallplates



ONQWP5001



ONQWP5002



ONQWP5003



ONQWP5004

ONQWP5001-**	Single Gang	4.08
ONQWP5002-**	Two Gang	7.14
ONQWP5003-**	Three Gang	10.19
ONQWP5004-**	Four Gang	12.90

**Color - AL-Aloe, BD-Bordeaux, CP-Cameo Pink, CM-Cement, CT-Citrus, CZ-Cozumel, CY-Cyan, GB-Gloss Black, KK-Khaki, LA-Light Almond, MS-Moss, NV-Nirvana, SD-Sand, SP-Spanish Red, TP-Taupé, TI-Titanium, WH-White

Centralite offers a range of keypads. The Classica and Europa series are the original and most cost effective options. Ultra and Mystique offer a more elegant look at a middle of the road price. Finesse features backlit, engraveable buttons for the ultimate look.

Standard Key pads

CL3271031-U*	Classica 1-Button Keypad	11.99
CL3271032-U*	Classica 2-Button Keypad	23.98
CL3271033-U*	Classica 3-Button Keypad	35.97
CL3271034-U*	Classica 4-Button Keypad	47.96
CL3271020-U*	Classica Kit, Includes 5 4-button, 5 3-button, 5 2-button, 2 1-button keypads	509.59
CL3271002-*	Europa 2-Button Keypad	21.98
CL3271004-*	Europa 4-Button Keypad	42.97
CL3271006-*	Europa 6-Button Keypad	64.95
CL3271010-*	Europa Kit, Includes 3 6-button, 6 4-button, 7 2-button keypads	474.62

*W-White, I-Ivory, A-Almond, LA-Light Almond, B-Black

Classica is our most popular keypad model. It offers a simple and clean matte finish look at a great price. The Classica kit is the best value and makes ordering easy. Classica keypads now have RJ-45 jacks and IDC 110 punch terminals on them and can be wired with CAT 5 using either terminal.



Classica



Europa

Wiring

Elegance XL Wiring:

- All Centralite keypads are wired using Cat5 cable. This wiring method can support a maximum of 7 buttons on a single keypad.
- From the MCP to any output (load panel, FSC, LVRB, HVRB) run Cat5
- From the MCP to SuperStars, run Cat5

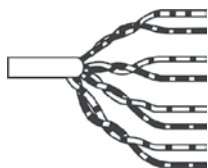

See pages 189-190 for wire and cable.

Related Parts

WAV5E04URBK1	Cat5e cable, 1000' box, variety of colors available	69.94
CARSC100A	Carlson new-work single-gang mud ring	1.10
A1ILVMB1	Arlington new-work single-gang mud ring	0.67

Finesse Premium Backlit Key pads

Order 1 Plate and 1 Assembly per complete keypad

CL1410101-(1,2,7)	Finesse 2-Button Keypad Plate	21.98
CL3412102-*	Finesse 2-Button Keypad Assembly	84.93
CL1410102-(1,2,7)	Finesse 4-Button Keypad Plate	21.98
CL3412104-*	Finesse 4-Button Keypad Assembly	84.93
CL1410103-(1,2,7)	Finesse 6-Button Keypad Plate	21.98
CL3412106-*	Finesse 6-Button Keypad Assembly	84.93

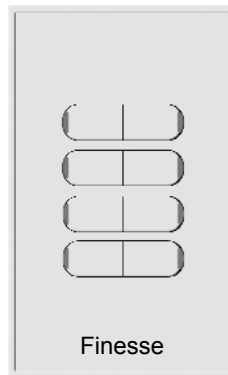

Finesse keypad buttons are backlit with a soft blue light. The light shows through the text when buttons are engraved.

Plate Options: 1-Black, 2-White, 7-Light Almond

*Assembly Color Options: BW-Black Button/White Frame, BB-Black Frame/Button, WB-White Button/Black Frame, WW-White Frame/Button, BL-Black Button, Light Almond Frame, LB-Light Almond Button, Black Frame, LL-Light Almond Button/Frame

Premium Key pads

CLULT-2B-2LB-*	Ultra Mercedes 2-Button Keypad	31.97
CLULT-4B-4LB-*	Ultra Mercedes 4-Button Keypad	47.96
CLULT-6B-6LB-*	Ultra Mercedes 6-Button Keypad	58.95
CLMERC30001-*	Ultra Mercedes Wallplate	6.00
CLMERC30060	Ultra Mercedes Subplate	5.00
CL1382101-*	Mystique Mercedes 1-Button Keypad	44.96
CL1382102-*	Mystique Mercedes 2-Button Keypad	54.96
CL1382103-*	Mystique Mercedes 3-Button Keypad	64.95
CL1382104-*	Mystique Mercedes 4-Button Keypad	74.94

*W-White, I-Ivory, A-Almond, B-Black
Call for additional color options.



Ultra Mercedes



Mystique Mercedes

Custom Button Engraving

All Centralite keypads ship with blank buttons. Engraving is available for \$3.50 (\$25 minimum order). We recommend hand-labeling the blank buttons for your customer for the first 30 days or so until they are comfortable with them. At that point the customer should know exactly what labels they would like. Engraving adds the professional touch to your work.

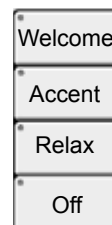

A great fit for 48 load and larger lighting jobs.

Elegance XL provides the ultimate in speed, reliability, and ease of installation. Simply wire all keypads with Cat5 and all loads with Romex back to the dimmer panels. Next, name the loads and keypad buttons. Work with your customer to create scenes that work for them. Finally, assign loads or scenes to the keypad buttons and you have a complete system!

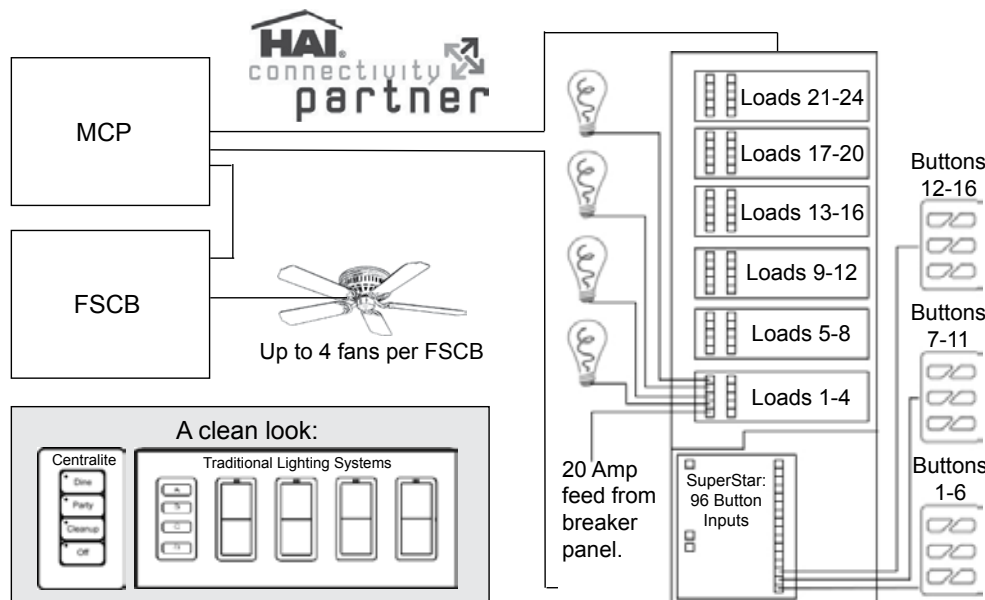

Elegance™ XL

- Controls lighting, ceiling fan, and high-current loads
- Dimmers support incandescent, magnetic, LED, CFL, and light motor (bathroom fan) loads
- Hardwired infrastructure provides incredible reliability and speed

How do I spec an Elegance XL system?

1. Start with an MCP-every system needs one
2. Add up to 8 output modules (24 load panels FSC, LVRB, HVRB)
3. Add enough SuperStars to support the number of buttons you need

What connections are on the MCP?

- (8) output drivers (24 load panels FSC, LVRB, HVRB)
- (4) SuperStar drivers
- (3) Serial Ports, 1 for programming, 2 for integration

A note on SuperStars:

The easiest approach to the SuperStar is to use the CL7252024 24 load panel with a SuperStar included. If keypads are wired to a separate location than loads, use the CL7252024-NS 24 load panel and separate SuperStars in their own enclosures.

System Components

CL3152096	MCP (Master Control Panel), one required per system, requires rough-in box, supports 192 loads	1099.12
CL1252300	Rough-In Box for MCP, required to mount MCP	49.96
CL7252024	24 Load Dimmer Panel with SuperStar input, supports 24 lighting loads and 96 button inputs	1748.60
CL7252024-NS	24 Load Dimmer Panel, supports 24 lighting loads	1476.82



CL3152096

SuperStars (Keypad Inputs)

CL4152040	SuperStar Board Only, 96 button inputs, can mount in bottom half of CL7252024NS	539.57
CL4252241	SuperStar mounted in enclosure, 96 total button inputs	649.48
CL4252202	STAR Pak, includes (2) STAR input boards mounted in enclosure, 192 total button inputs	419.66
CL4252203	STAR Pak, includes (3) STAR input boards mounted in enclosure, 288 total button inputs	554.56
CL4252204	STAR Pak, includes (4) STAR input boards mounted in enclosure, 384 total button inputs	689.45



CL7252024

System Options

CL3321005	Keychain Remote Kit, includes (2) remotes and a receiver, wires to SuperStar like a keypad button	134.89
CL1320500	Extra Keychain Remote, use with above kit	37.97
CL4152001	Fan Speed Controller (FSC), connect up to 4 ceiling fans, provides low/medium/high/off control	484.61
CL4252311	(1) Fan Speed Controller in enclosure	619.50
CL4252312	(2) Fan Speed Controllers in enclosure	1074.14
CL3152080	Low Voltage Relay Board (LVRB), 16 relays, use for landscape lighting, window treatments, etc.	484.61
CL4252411	(1) Low Voltage Relay Board in enclosure	619.50
CL4252412	(2) Low Voltage Relay Boards in enclosure	1074.14
CL3152070	High Voltage Relay Board (HVRB), 16 relays, great for motor loads, heavy loads, etc.	484.61
CL4252511	(1) High Voltage Relay Board in enclosure	619.50
CL4252512	(2) High Voltage Relay Boards in enclosure	1074.14

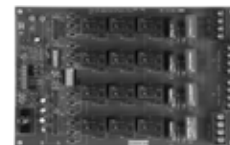

CL4152001



CL3152080



CL3152070

Questions? Give Worthington a call today.

JetStream - Wireless Lighting from Centralite



With JetStream there are no external repeaters, antennas, base stations, or separate controllers required. Any button can control any scene, event, or load, from anywhere in the house! To configure the system, simply discover all devices, create scenes, and assign scenes or loads to buttons.

Pro Pak

Includes everything needed to get a system up and running

CL6255006-SCW	(5) 3-Button Dimmers, (1) RS-232 Bridge, Includes White and Light Almond colors	505.84
---------------	---	--------

Dimmers & Switches

CL3385001-SC*	1-Button 800W Dimmer	69.94
CL3385003SC-*	3-Button 800W Dimmer	79.94
CL3385001-RSC*	1-Button 8 Amp Relay Switch	69.94
CL3385003-RSC*	3-Button 8 Amp Relay Switch	79.94

*=W-White, I-Ivory, LA-Light Almond, B-Black

Accessories

CL4255003	Car Remote	53.96
CL4255008	8-Button Tabletop Controller, White	98.92
CL4255050	Plug-In Lamp Module, White	64.95
CL3155000	RS-232 Bridge with Time Clock	158.87
CL3155002	USB Bridge - required for system setup	128.90

Screwless Wallplates

Not Included with Dimmers/Keypads

CL1071001-*	Single-Gang Wallplate	3.00
CL1071002-*	Double-Gang Wallplate	5.00
CL1071003-*	Triple-Gang Wallplate	6.99

JetStream uses the popular ZigBee™ wireless communication. Nodes (any device on the system) act as repeaters to create a true self-healing mesh network. Dynamic routing algorithms in each device ensure that signals take the quickest and most efficient route from point A to point B. All this adds up to higher reliability and fewer callbacks.

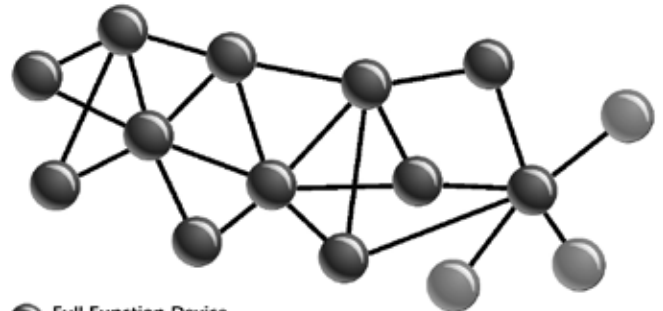

- Full Function Device (performs network routing functions i.e. dimmers, keypads, bridges, etc.)
- End Device (i.e. Car Remote)

JetStream Features:

- 200+ devices in network
- 100 scenes
- 50 timed events (with RS-232 bridge)
- Soft On / Off
- 512 dim levels
- Adjustable LED intensity on buttons
- Configuration is stored in each device, plus a backup is made on PC
- Custom engraving available

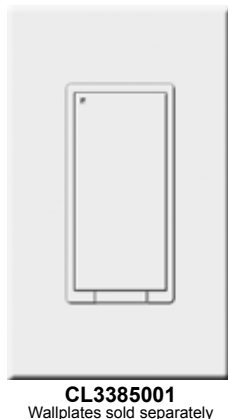

JetStream setup software (above) is free to dealers and is a quick and powerful tool used to configure systems. First, add all devices to the network and name them. Next create scenes with input from your customer. The only thing left then is to assign scenes or loads to buttons. JetStream allows you to group loads by room for easy scene configuration.

USB Charger with Tamper-Resistant Receptacle



LEVT5630-W

LEV47112-W

Leviton's T5630 offers a combined 2.1A of charging power and a 15A/125V Tamper-Resistant Receptacle. It allows you to charge 2 USB devices at once, while still leaving the receptacle open for further charging needs. The LEV47112 hangs in an adjacent Decora port to give your customer a place to hang their device while charging.

LEVT5630-*	2.1A Dual USB Charger with 120VAC Receptacle	18.87
LEV47112-*	Decora Mobile Device Station	7.44
* Specify color: W-White, T-Light Almond		

Wall-Mount Devices with Built-In Night-Lights



LEVX7592

LEV6526-W

LEV6527-W

Leviton offers a wide range of wall-mount devices with night-lights. These products are easy to install and the bright LED provides great pathway lighting.

LEVT6525-*	Decora Tamper-Resistant Receptacle with LED Guide Light, 15A-125VAC	7.87
LEVX7592-*	15A-125V Receptacle, Tamper-Resistant Duplex GFCI/Guide Light with LED indicator	19.66
LEVX7892-*	20A-125V Receptacle, Tamper-Resistant Duplex GFCI/Guide Light with LED indicator	21.72
LEV6526-*	Decora Single Pole Switch/LED Guide Light, 15A-120VAC, 1/2 HP	16.59
LEV6527-*	Decora Full LED Guide Light, 1W-120VAC	16.71
* Specify color: W-White, T-Light Almond, E-Black		

Evr-Green Residential Vehicle Charging Stations

Leviton offers a complete solution for residential, commercial and public plug-in electric vehicle (PEV) charging: the Evr-Green™ line of electrical vehicle supply equipment (EVSE). Evr-Green products are compliant with all industry standards and compatible with all major auto manufacturers' electric vehicles which are SAE J1772 compliant.

16A Level 2 Chargers



LEVEVB22-3PT

Leviton's "Level 2" Home Charging Station provides up to 3.8kW (16A @ 240V) "quick-charging" of any SAE J1772™ Compatible Electric Vehicle. The intuitive user interface and automatic features make the charging process extremely simple. Leviton's patent pending mounting system allows for a do-it-yourself installation when used with an EVK02-M installation kit.

LEVEVB22-3PT	160 Level 2 240V 16 Amp Charger, 18' cable, plug-in	748.15
LEVEVK02-M	Installation Kit for 160 Charging Station. Includes Safety Cover and Wall Mount Bracket	53.34

32A Level 2 Chargers



LEVEVB32-8ML

Leviton's Evr-Green™ 320 Charging Station enables fast-charging of any SAE J1772™ Compatible Electric Vehicle. Leviton's patent pending mounting system allows for a do-it-yourself "plug-in" installation when used with an EVK05-M installation kit.

LEVEVB32-5ML	320 Level 2 240V 32 Amp Charger, 25' cable, plug-in	981.44
LEVEVB32-8ML	320 Level 2 240V 32 Amp Charger, 18' cable, plug-in	981.44
LEVEVK05-M	Installation Kit for 320 Charging Station. Includes Safety Cover and Wall Mount Bracket	63.90

Portable Charging Station and Evr-Green Accessories

Leviton's Evr-Green Portable Charger provides the most flexibility for charging your electric vehicle. The 12" supply cord can be plugged into any standard 15A receptacle found in just about any house, building or public facility. You won't need to worry about limiting the distance of your trip based on the range of a single charge! It features an 18' charge cord with a J1772™ Compliant Charge Connector which securely docks in the unit when not in use. The selectable charge rate, either 12A or 7A, can be used to minimize the risk of circuit overload. The unit also has an Auto-Restart function which enables charging to restart following a minor fault, thereby reducing the chance of being stranded with a low state of battery charge. Built-in communication verifies proper connection to the vehicle and electrical connections before charging can begin.



LEVEVC11-300



LEV7591-PEV



LEVDS30-AX

The T7591-PEV GFCI Receptacle features a guide light that is photo-sensor controlled, which makes it easier to locate the receptacle in the dark. It meets NEC Code Requirements for use with electric vehicle charging systems and also features SmartLockPRO which includes: Line/Load reversal indicator, "End-of-Life" Indication, and "Surge-Hardened" electronics to offer superior resistance to surges and over voltages.

LEV7591-PEV	GFCI Receptacle with LED Guide Light 15A	20.47
Safety disconnect switches provide secure protection with Evr-Green electric vehicle supply equipment. They can safely cut power to the circuit for equipment servicing.		
LEVDS30-AX	30 Amp Non-Fused Safety Disconnect Switch	194.51
LEVDS60-AX	60 Amp Non-Fused Safety Disconnect Switch	264.88

LEVEVC11-300	120 Portable Charging Station 120V 7A/15A. Selective charge rate	498.35
--------------	--	--------

Looking for commercial solutions, including charging stations which accept credit cards? Call for details.

Occupancy Sensors - Simple Lighting Automation

One of the simplest ways to offer your customers lighting automation is to use one of Leviton's occupancy sensors. Occupancy sensors add a simple level of automation where it is needed without adding the cost of a whole home control by providing automatic ON/OFF switching of lighting loads for enhanced convenience, security and long-term energy savings. See the below examples for some of the most common uses of occupancy sensors.

Scenario #1 - Bathroom



LEVROSS10-IDW

The Need: A way to provide light in a bathroom without your customer having to find a light switch in the middle of the night.

The Solution: A night-light wall switch occupancy sensor. This product can replace an existing light switch and provides a soft, low wattage LED light to allow your customer to safely find their way into the room at night.

LEVOSNLI-ID*	800W incandescent or 1200VA fluorescent, and 180 degree view, auto on/off	47.74
LEVROSS10-ID*	800W incandescent or 1200VA fluorescent, and 180 degree view, manual on/auto off, Title 24	47.74

* Specify color: W-White, I-Ivory, T-Light Almond

We carry Leviton's full line of occupancy sensors, which are designed to fit a wide range of applications including outdoor and commercial installations.

Please call us for more information or for pre-sales design assistance (800) 282-8864.

Scenario #2 - Laundry Room



LEVODC0S-I1W

The Need: A way to turn on the light in a laundry room while your customer has a basket of laundry in their hands.

The Solution: A ceiling-mount self-contained sensor. This product will turn on the light when they enter the laundry room and will turn it off after they leave.

LEVODC0S-I1W	1000W incandescent or 1000VA fluorescent, 360-degree view	79.01
--------------	---	-------

Scenario #3 - Foyer

The Need: A way to conveniently ensure that your customer doesn't walk into an unlit home.

The Solution: A wall-mount occupancy or vacancy sensor mounted by the entrance way.

LEVIPS05-Z	5A relay occupancy sensor. Single pole, 180 degree view, 900 sq. ft. coverage.	25.98
LEVIPS15-Z	15A relay occupancy sensor. Single pole & 3-way, 180 degree view, 900 sq. ft. coverage.	28.09
LEVIPSD6-Z	Occupancy detector and dimmer. 180 degree view, Single Pole & 3-Way, 600 Watt Incandescent, 150W Dimmable LED & CFL.	39.34
LEVIPV05-Z	5A relay vacancy sensor. Single pole, 180 degree view, 900 sq. ft. coverage.	25.98

EZ-MAX Hardwired Lighting Control System by Leviton

Now you can offer simple energy management systems that pay for themselves, sometimes in as little as one year. If you're like many installers in our industry, your business has been affected by the economy. Although we focus on residential systems integration here at Worthington, our goal is to help you branch out into related areas of business that can help keep you in the black in these trying times. With energy costs on the rise, many commercial building managers are exploring energy saving options. Although residential energy management can be difficult to justify to a homeowner from a cost perspective, on the commercial side, energy management offers proven savings. EZ-MAX from Leviton is one of these products that we would like to introduce. It's a flexible lighting control cabinet that lends itself to timer and dusk to dawn lighting applications and even area lighting when local keypads are attached. See the scenarios below for a better idea of where EZ-MAX is a good fit.

EZ-MAX Relay Panels and Relay Cards

LEVRELAY-L30	1-pole, NO/NC relay card, 30A, 120-277V	28.14
LEVRELAY-2PL	2-pole, NO relay card, 20A, 208-480V	37.97
LEVR08BD	8 Relay Panel, (8) NO relays	481.31
LEVR08BD-L04	8 Relay Panel, (4) 30A NO/NC relays	617.51
LEVR08BD-L08	8 Relay Panel, (8) 30A NO/NC relays	742.03
LEVR08BD-208	8 Relay Panel, (8) 2-Pole NO relays	836.37

EZ-MAX Accessories

LEVPCOUT	Outdoor Photocell for EZ-MAX	174.86
LEVLVS-2W	2-button low-voltage switch	37.77
LEVLVS-5W	5-button low-voltage switch	37.77



LEVRELAY-2PL



LEVR08BD

Features:

- Easy programming using an offline editor or wizard-driven LCD display and oversized buttons
- Easy standard programming configuration
 - Occupancy sensors: manual-ON or auto-ON applications
 - Photocells: interior or exterior application modes
 - Photocell light level trip points: on or off
- Integrated astronomical time clock
- Time clock and scheduler
- Sunrise/sunset time clock events
- Integrated astronomical time clock
- Accepts input from momentary, maintained or toggle switches as well as low-voltage input from photocells and occupancy sensors for a comprehensive yet easily installed energy management solution

Scenario:

This could range from a small fabrication shop to a section of a large warehouse. EZ-MAX takes simple scheduling to the next level. Include wall-mounted low voltage switches to provide users with local control and add occupancy sensors for even more energy savings. EZ-MAX will evaluate the status of the schedule, switches, and sensors to determine the power state of a load for maximum energy savings.

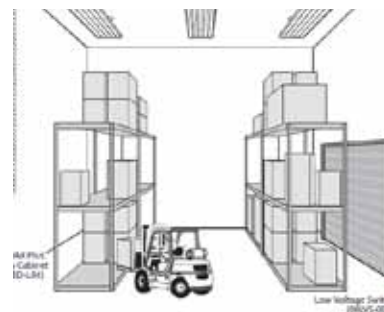

The Complete Surge Protection Solution



With more and more “smart” devices, homes of today are more susceptible to damage caused by surges than ever before. Many consumers have no surge protection and most who employ some form of surge protection have an inadequate amount. Even a single surge on the main line coming into the home can cause tens of thousands of dollars in damage.

Be a hero to your customers: educate them on proper surge protection and give them a complete solution with Leviton’s surge protective devices (SPDs). Leviton’s SPDs are designed to be used as a surge protection network, knocking down large surges at the panel to make them manageable by smaller SPDs at the point-of-use.



Ask yourself, “What am I doing to protect my installations?”

Type 1 - Secondary Surge Arresters



Typically mounted on the service side of the main service panel, Leviton’s Type 1 SPDs prevent large, external transient spikes from entering into the home’s electrical wiring. Listed models have a status LED so your customer can tell at a glance if their home is still protected.

LEV51120-3R	120/240V Single Phase Panel Protector in a NEMA 3R Enclosure	248.05
LEV55240-ASA	120/240V Parallel Wired Surge Arrester, NEMA 3R Rated	128.00

Type 2 - Panel Mount Surge Protectors



Installing a panel-mount surge protector is an important step in preventing damage to your customer’s expensive electronics. In most cases, a panel-mounted surge protector is the only defense against transient voltage for line voltage devices, such as automated lights. Any automated lighting installation isn’t complete without some form of whole-house surge protection.

LEV51110-1	Panel-mounted surge protection for power, includes surface-mount brackets & flush-mount cover, 120/240VAC, 48kA max surge current rating, status line 1 & 2 with LEDs.	49.89
LEV51110-PTC	Panel-mounted surge protection for power, cable/satellite & 2 pair telephone, includes surface-mount brackets & flush mount cover, 120/240VAC, status line 1 & 2 with LEDs.	133.92
LEV51120-1	Panel-mounted surge protection device for power, 120/240VAC, status line 1 & 2 w LEDs, compatible with powerline carrier (PLC).	187.59
LEV32120-1	Panel-mounted surge protection device, 120/240VAC w/ LEDs, use with generators.	368.11



Type 3 - Point Surge Protection - Power Strips and Receptacles

Protecting a circuit breaker panel may not be enough to stop a surge. Point-to-point surge protection is a must to feel confident that valuable electronic devices are protected.

Leviton’s surge protection strips provide superior protection for everyday use in professional work areas and home offices, protecting computers, peripherals, and other electronic devices from damaging surges, voltage transients and noise spikes.

Part No.	Protects	Recommended App.	Note	Price
LEVS1000-PS	6 Outlets	Power	6 Standard Outlets	17.71
LEVS1000-PTC	6 Outlets	Power+Telco/Coax	6 Standard Outlets	22.41
LEVS2000-PS	9 Outlets	Power	6 Standard + 3 Wide Outlets	28.31
LEVS2000-PTC	9 Outlets	Power+Telco/Coax	6 Standard + 3 Wide Outlets	34.21
LEV5505-190	19” rack mount protector	12 receptacles	Breaker, switch & LEDs	92.30
LEV5280-*	Dual receptacle	Receptacle	Fault LED	29.73

* W-White, I-Ivory, B-Blue, GY-Grey, T-Light Almond, blank-Brown



For customers who worry about having bulky power strips or for installations where space is a concern, Leviton offers a line of surge protection receptacles. The low cost of these receptacles, combined with their ease of installation, means they can be placed anywhere you have a standard electrical outlet. So with a small investment, your customer can have the assurance that their equipment is well-protected. This is an excellent solution for recessed TV boxes, structured wiring cans, or a computer in a home office.

Leviton’s “True Whole-House Surge Protection” Limited Warranty

The Leviton “True Whole-House Surge Protection” program provides connected equipment coverage on the panel-mount (51110 and 51120) Service Entrance SPD-up to \$10,000 to repair or replace residential “standard white appliances” that sustain surge damage. A standard white appliance is defined as a washer, dryer, stove, refrigerator, freezer, dishwasher, HVAC unit, etc. The 51120-PTC will provide \$10,000 coverage for residential standard white appliances as well as \$25,000 coverage for protected dial-up telephone, satellite receiver and CATV equipment ports. Please contact us for a copy of the warranty.

Green Power Surge and UPS

The ECO-UPS System connects to your computer's USB port. When your computer shuts down or enters standby, the UPS waits three minutes to make sure your computer is not rebooting or temporarily unable to communicate, then Green Outlet technology automatically cuts power to the designated energy-saving outlets. Cutting power to the energy-saving outlets prevents idle devices from wasting electricity. The battery-backup outlets and surge-only outlets remain powered, supporting always-on devices like routers and broadband modems. When your computer starts up again, Green Outlet technology automatically restores power to the energy-saving outlets and your entire system is ready to use.

**TRLECO350UPS****TRLECO650LCD****TRLTLP76MSG****TRLAV550SC**

TRLECO350UPS	UPS 350VA, 180 Watts, 3 UPS supported outlets; 3 surge only outlets, 2 are designated Eco outlets	56.83
TRLECO550UPS	UPS 550VA, 300 Watts, 4 UPS supported outlets; 4 surge only outlets, 3 are designated Eco outlets	76.19
TRLECO650LCD	UPS 650VA, 325 Watts, 4 UPS supported outlets; 4 surge only outlets, 4 are designated Eco outlets	86.81
TRLTLP1210SATG	12 Outlet Surge, 2-line coax, 1-line RJ11/RJ45 Home/Business Theater Surge Suppressor	84.93
TRLTLP76MSG	6 individually controlled eco outlets plus 1 always-on outlet, 1080 joules Home/Business Surge Suppressor	26.85
TRLAV550SC	Structured Wiring UPS 550VA, mounts in can or on a wall. Regulated 12VDC output for 4 devices, 4 110VAC Outlets.	147.38
TLRBC11A	UPS Replacement Battery Cartridge Kit. 4 batteries for major brand UPS systems. Call for compatibility.	302.76

Power Distribution Units

Switched power distribution units offer advanced network control and monitoring with the ability to turn on, turn off, recycle or lock-out power to each individual receptacle, monitor site electrical conditions and remotely monitor output power consumption. The software interface supports custom notification via e-mail and can control outlets in real-time to remotely reboot unresponsive network hardware.

TRLPDUMH15NET	16 switched outlets, 15 Amp 120V, horizontal, 1U rack-mount, built-in web/network interface, visual load meter	404.68
TRLPDUMV15NET	16 switched outlets, 15 Amp 120V, vertical mount, built-in web/network interface, visual load meter	531.70
TRLPDUMH20NET	16 switched outlets, 20 Amp 120V, horizontal, 1U rack-mount, built-in web/network interface, visual load meter	455.26
TRLPDUMV20NET	16 switched outlets, 20 Amp 120V, vertical mount, built-in web/network interface, visual load meter	555.31



New Rack Mount UPS's

**TRLSMART1000RM1****TRLSMART1500RM2****TRLSU1000RTLX2U****TRLSU2200RTLX2U**

TRLSMART1000RM1	UPS 1000VA/640 Watts, Line Interactive Sine Wave, 1U rackmount, 6 Outputs	567.05
TRLSMART1000RM2	UPS 1000VA/700 Watts, Line Interactive Sine Wave, 2U rackmount, 6 Outputs	499.60
TRLSMART1500RM2	UPS 1500VA/1000 Watts, Line Interactive Sine Wave, 2U rackmount or tower, 8 Outputs	651.98
TRLSU1000RTLX2U	UPS 1000VA/900 Watts, Interactive LCD display, 2U rackmount or tower, 6 Outputs	623.25
TRLSU2200RTLX2U	UPS 2200VA/1800 Watts, Interactive LCD display, 2U rackmount or tower, 7 Outputs	1166.57

Audio Video Line Conditioners/Surge Suppressors

**TRLHTSWIVEL6****TRLAV810****TRLAVBAR6****TRLAV3500PC**

TRLHTSWIVEL6	6 rotatable outlets for limited space locations. Surge/spike protected outlets, 1-line 2.2GHz coax, 1-line telco/modem protection.	23.73
TRLAV810	8-outlet. Surge and spike protection, 2-line 2.2GHz coax, 1-line telco/modem protection.	33.72
TRLAVBAR6	6-outlet. Surge and spike protection, EMI/RFI filtering. Metal housing, 2-line 2.2GHz coax, 1-line ethernet.	54.96
TRLAV3500PC	A/V Isobar Power Conditioning Center, 8 Surge/spike protected outlets, 3-line 2.2GHz coax, and 1-line telco/modem protection.	158.62

Worthington Distribution has access to Tripp-Lite's full line of UPS products. If you don't see a model on this page, just call and ask!

The Profit Potential of Motorized Window Treatments

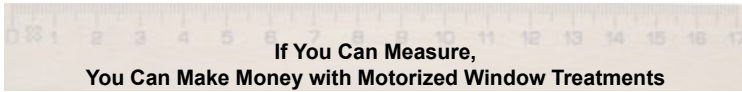

Worthington Distribution has been in the motorized window treatment business for almost a decade. In that time, we've discovered that with the right help, anyone who can use a tape measure is qualified to specify and install window treatments. Draw on our knowledge the next time you are quoting a lighting solution, and discover just how simple natural lighting control can be.

Open the Window to New Revenue



- If a window treatment is inaccessible due to its height or location, it is a prime target for motorization
- If there is a projector or flat screen television, natural light needs to be controlled for better viewing
- The average house has 17 windows; that translates to 17 up-sell opportunities
- Are you letting another trade profit from window treatments? Why not you?



Worthington Distribution is behind you during every step of the motorized treatment ordering process. From pre-sale design assistance to after-sale installation and programming walkthroughs. The resources we provide allow you to sell motorized natural lighting control solutions with confidence. The only way to make sure you don't make money with motorized solutions is to not offer them to your customers.

Motorized Solutions from Worthington Distribution

We offer a wide variety of motorized solutions. From small, battery-powered roller shades hung in a hard-to-reach place to sun-blocking awnings for a patio, we carry it all. Below you will find a brief description of each type of motorized solution. See each treatment type's respective pages for more details. If you have any questions, please feel free to send an email to shades@worthdist.com or call us, 1-800-282-8864.

Drapery Tracks



Motorized drapery tracks are a great solution for large windows, doorways, or even in front of the display in a home theater to provide a movie theater experience. Built-in touch control engages the motor when someone pulls on the fabric, preventing damage to the motor if they don't realize that the treatment is motorized.

Drapery track solutions are on page 42.

Retrofit Motors for Tilting Blinds

Blinds create living environments that are comfortable, energy efficient and add an element of convenience and luxury to any interior space. Chances are, most homes you walk into will already have blinds installed. Worthington Distribution offers a solution to use your customer's existing tilting blinds to create a motorized solution and control natural light without changing their décor.



Retrofit blind motor solutions are on page 42.

Motorized Awnings



Patio and deck awnings can be mounted on a wall, under a soffit, or on your roof. This offers a neat, clean look whether the awning is extended or retracted. There are no unsightly poles and no costly seasonal put up and take down.

Motorized awning solutions are on page 43.

Roller Shades



Roller shades are the most common treatment and are available in a wide variety of styles, including transparent and blackout fabrics. Motorized roller shades provide a traditional, clean look to any room, with the added convenience of touch-free control. In addition to providing privacy, roller shades offer the best UV (ultraviolet) protection for the home, which can reduce fading of painted walls, carpeting, and furniture. One of the easiest sales opportunities with motorized treatments is to offer your customer a solar-powered, wireless-controlled shade with no batteries to replace.

Roller shade solutions are on pages 40 and 41.

Honeycomb Shades

In addition to their clean appearance, honeycomb shades provide the best privacy, sound absorption, and energy efficiency. Honeycomb shades are an attractive and versatile window treatment solution with a wide variety of colors as well as several levels of light control, from light filtering to blackout. These are the easiest solution to install. The installation and programming of these shades take only a few minutes. Maintenance of the honeycomb shades is also simple, after several years of normal operation, D-cell batteries can be replaced with the press of two catches located in the headrail.



Honeycomb shade solutions are on pages 26 and 27.

Motorized Treatment Integration Program

We have the experience to make your projects easy. Browse to: www.worthingtondistribution.com/shades For color samples, free training, and to request a quote.

RTS - Motorized Window Treatment Control Simplified



Radio Technology Somfy® (RTS) is Somfy's exclusive control platform which enables users to adjust motorized interior window coverings and motorized exterior products such as awnings from virtually anywhere inside or outside the home. Simply press a button on a remote control or wall switch and motorized interior or exterior treatments move with ease. RTS receivers are built directly into the motors, with no need to run communication wires to window locations. Using battery power options ensure an entirely wire-free installation, making Somfy RTS the perfect solution for any retrofit or new-home installation.



Radio Technology Somfy®

The key benefits to using Somfy RTS controls:

- Flexible control options: Control multiple shades from one transmitter, or control one shade from multiple transmitters.
- Omnidirectional RF control: There is no need to point the transmitter at the shade, allowing your customer to operate their treatment without having line-of-sight to the treatment.
- Long range control: Transmitters have an effective range of up to 65 feet with the option of adding a repeater for treatments located in remote areas of the home.

Somfy RTS Transmitters and Accessories

SOM1810632	1-channel Telis Pure Remote. Up/down control plus one preset position.	54.73
SOM1810633	5-channel Telis Pure Remote. Channels 1 through 4 and all channels.	71.04
SOM1811081	16-channel Telis Pure Remote.	226.59
SOM1810813	DecoFlex 5-channel Wireless In-wall Controller.	133.89
SOM1810791	RTS Repeater. Limit one per system.	184.13

Worthington Distribution offers the entire Somfy line of RTS transmitters. Please call for additional options.



SOM1810633



SOM1810813

Power Solutions for Roller Shade and Blind Motors

Somfy's Solar Pack - Bringing New Light to Motorized Window Treatments
The new WireFree™ solar pack harnesses renewable solar energy to power motorized window coverings. The low-profile photo-voltaic panel is easy to conceal while reducing the need for battery replacement for at least 5 years. Be sure to purchase a SOM9015781 charging kit with your first solar pack to pre-charge the batteries and ensure optimum performance.



SOM9015575 - Installed

SOM9015575

SOM9015575	WireFree Solar Pack	82.40
SOM9015624	Replacement Rechargeable Battery	53.05
SOM9015781	Pre-installation AC Charger	87.64

Other Power Options

SOM9014020	Reloadable Battery Tube (Batteries not included)	20.47
SOM9014834	8 AA Lithium Battery Package	27.15
SOM9015580	Battery Tube Harness	1.77
SOM1822192	12VDC Plug-in Power Supply, 25' cable (white)	78.08

Other Control Options

HAI offers support for Somfy RS-485 and ILT motors. The integration is 2-way and there is support for both direct motor control as well as group commands. In addition, the HAI can control shades via contact closure or speak RTS through Somfy's URTSII.



SOM1810872	16-channel Universal RTS Interface (URTSII)	405.82
SOMHAI CBL	6' cable, connects an HAI with the URTSII	9.99
SOM1810493	RTS Transmitter with Three Dry Contact Inputs	69.34

Somfy can speak Z-Wave or ZigBee, too. Simply add on one of the following adapters and learn the shade into your network.



Z-Wave and ZigBee Adapters

SOM1870171	Add Z-Wave to an RS-485 or ILT motor	219.73
SOM1870202	Plug-in Z-Wave to RTS Wireless interface	446.39
SOM1870220	Add ZigBee HA Profile to an RS-485 or ILT motor	199.84

The most popular control solution for Somfy motors is RTS, however, there are many other control options. For contact closure, or Somfy Digital Network (RS-485 or ILT) control options, please visit our website: www.worthingtondistribution.com/shades or give us a call at (800) 282-8864

Ordering Complete Motorized Shades

Use the Following Chart to Determine the Price of Your Motorized Shade*
Find the height and width of the treatment you will be ordering.
Round up to the nearest height/width.

		Maximum Width Of Shade (Inches)													
		24"	30"	36"	42"	48"	54"	60"	66"	72"	78"	84"	90"	96"	
Maximum Height Of Shade (Inches)	36"	344	349	355	357	361	382	383	395	397	417	425	439	452	
	42"	347	351	358	360	365	387	390	401	403	425	439	452	464	
	48"	349	353	361	362	368	393	395	406	407	439	452	464	479	
	54"	350	354	363	366	369	398	400	411	413	452	463	479	488	
	60"	352	357	368	369	373	404	405	418	419	463	479	488	494	
	66"	353	359	369	371	377	409	410	423	424	479	488	494	500	
	72"	355	362	372	373	380	415	416	428	429	488	494	499	505	
	78"	356	364	375	377	383	420	421	433	Larger sizes available with non-battery motors, call for a price quote.					
	84"	359	366	378	379	387	426								
90"	361	369	382	383	390	431									
96"	367	376	393	394	397	448									
3" Fascia	21	25	26	30	34	38	42	45	49	53	57	60	64		



* Control options sold separately (page 40). Pricing includes a 12VDC RTS motor with solar powered battery, add \$42 for a quiet 24VDC RTS motor with power supply. Additional motor options also available, please call or e-mail shades@worthdist.com for a quote.

Exploring Fabric Options

Sheer/Transparent	Light Filtering/Translucent	Blackout/Opaque
<ul style="list-style-type: none"> Natural light and glare control Provides some UV protection Provides a clear view through the fabric 	<ul style="list-style-type: none"> Natural light filtration Increased UV protection Diffused view through fabric 	<ul style="list-style-type: none"> Fully blocks natural light Full UV protection Provides privacy
Examples: Alkenz Sunshadow 3000 Net 10% Open Mermet E Screen 10% Open Phifer Sheerweave 1000	Examples: Alkenz Sunshadow 3000 Net 5% Open Mermet E Screen 5% Open Mermet A Screen	Examples: Mermet Edessa Mermet Geneva
<p>For a full listing of fabric styles and colors, browse to www.worthingtondistribution.com/shades. Some premium fabrics carry additional costs. Fabric samples are available for \$10 per each swatch.</p>		

Window Treatment Automation Accessories

Looking to control your motorized shades based on a schedule or even on the amount of light or heat in the room? We have your solutions! Also compatible with RTS drapery tracks and motorized tilting blinds.

Automation Accessories from Somfy

SOM9013707	Sunis Indoor WireFree™ RTS Transmitter. Use to open or close window treatments based on natural light levels. Can be mounted directly on the window.	197.06
SOM9013708	Thermo Sunis Indoor WireFree™ RTS. Same as SOM9013707, but adds temperature sensing to control window treatments.	226.59
SOM1805176	Chronis Comfort RTS Timer. 7-day scheduler. Program up to four events (up/down commands) per day.	179.81

We carry the entire line of Somfy RTS transmitters. Please call for more options.



SOM9013708



SOM1805176

Motorized Drapery - Glydea

Motorized draperies add distinction to any living space and are great for home theaters, too. Somfy's Glydea™ is the most innovative motorized drapery solution available today. This powerful yet quiet solution will elevate your experience with motorized draperies so that you can effortlessly create a comfortable and convenient interior.

- Extremely quiet drapery system (<44dBA)
- Integrated power supply, just plug into 110VAC
- Touch Motion: Pull the fabric, the motor begins to move
- The Glydea 60 motor can pull up to 132 lbs./19.6 ft of fabric
- Reversible mount allows the motor side to be changed in the field

Need help determining drapery rod length?

If you need to order a motorized drapery rod based on the viewable opening in the fabric, you will need to account for the fabric "stack." Browse to our website www.worthingtondistribution.com/shades for resources to determine the correct measurement.

Maximum Width	5'	6'	7'	8'	9'	10'	11'	12'	13'	14'	15'	16'	17'	18'	19'
Brackets Needed	3			4			5			6			7		
Pinch Pleat: Center - 3 carriers/ft	645	661	675	692	709	743	758	780	795	815	831	864	883	900	935
Pinch Pleat: Side - 3 carriers/ft	639	654	668	686	703	737	752	774	788	809	825	858	877	894	929
RippleFold 80%: Center - 5 carriers/ft	675	697	717	740	763	803	824	852	873	899	921	960	985	1,008	1,049
RippleFold 80%: Side - 5 carriers/ft	669	690	710	734	757	797	818	846	866	893	914	954	979	1,002	1,043
RippleFold 100%: Center - 6 carriers/ft	684	707	729	753	779	820	843	873	895	923	946	987	1,014	1,039	1,082
RippleFold 100%: Side - 6 carriers/ft	678	701	722	747	772	814	837	867	889	917	940	981	1,008	1,033	1,076
RippleFold 120%: Center - 7 carriers/ft	692	717	741	767	794	837	862	893	917	947	972	1,015	1,043	1,070	1,114
RippleFold 120%: Side - 7 carriers/ft	686	711	735	761	788	831	856	887	911	941	966	1,009	1,037	1,064	1,108

Pricing above is for a Somfy Glydea 60 motorized drape motor with carriers and track. Control is via contact closure. Shipping and brackets are not included. All lengths 108" and longer will be broken down for shipping and will need to be reassembled on site (instructions included). The Glydea drapery system is available to 36' long. In addition, curved tracks are available. Call for pricing on tracks not listed above.

Motor Upgrade options	RTS Wireless - \$74.16	RS-485 - \$84.24	Z-Wave Wireless - \$156	ZigBee HA Pro - \$156
-----------------------	------------------------	------------------	-------------------------	-----------------------



See page 40 for RTS control solutions.

Call for RS-485 control solutions.



See pages 9-17 for Z-Wave control solutions.

Call for ZigBee HA control solutions.



Drapery Bracket Options - Not Included in Pricing Above		
SOM1780907	One Touch Ceiling Bracket	2.25
SOM1780906	Swivel Ceiling Bracket: less rod/ceiling light gap	1.05
SOM1782054	4.5" - 6" Adjustable Wall or Ceiling Bracket Kit	6.89
SOM1782053	8.75" - 10.25" Double Wall-mount Bracket Kit	10.21

Glydea Drapery Motor Accessories		
SOM9154205	IR receiver for the Glydea motor	39.15
SOM1870133	IR remote - use with the 9154205 IR receiver	27.33
SOM9014599	Limit tool for the Glydea Drapery Motor	25.00
SOM9014793	Cable for use with SOM9014599	15.16

Retrofit Motorization Options for Existing 2" Blinds



The Most Cost-Effective Solution: Automate Existing Window Treatments

If you have a customer who balks at the prospect of replacing their horizontal tilting blinds with all new window treatments, adding a motor to the blinds they already own is a terrific solution. This allows you to add natural lighting control without changing the customer's décor. The motor replaces the existing drive system while remaining out-of-sight in the headrail and is compatible with any Somfy RTS transmitter for control. Add a solar-powered battery solution for a completely wire-free retrofit solution your customer will love.

Motor and Headrail Adapter and Remotes

SOM1000678	Tilt Motor, 12VDC, lift up to 30 lbs., black	84.33
SOM9014529	Headrail Adapter for 2" x 2 1/4" Headrail	4.43
SOM9014528	Low Profile Adapter for 1.5" x 2 1/4" Headrail	4.43
SOM1810765	Telis 5-channel RTS Remote for Tilt Motors - Pure	141.10
SOM1810974	Telis 1-channel RTS Remote for Tilt Motors - Pure	99.90



Tilt Motor and 9014528 Headrail Adapter

Wondering if your blind is too large? The SOM1000678 motor can tilt materials weighing up to 30 lbs.

Optional Shaft Adapters

To ensure that your tilting blind can be motorized:

- The headrail must be between 1.5" and 2 1/4" high.
- Look at the main shaft in the headrail of the blind and choose a matching adapter (if the shaft is 1/4" square no adapter is needed).

SOM9014535	5.6mm Hexagonal Adapter	1.11
SOM9014536	D Rod Adapter	1.11
SOM9014540	4mm Square Adapter	1.11



9014535



9014540



9014536

Silhouette Motorized Awnings

The Silhouette awning line offers total customization to harmoniously blend with your customer's décor. Select from Sunbrella's wide color palette of 100% solution dyed, marine grade fabrics to express your customer's design needs. Silhouette awnings can be mounted to a wall, under a soffit, or even on the roof.[†]

Silhouette awnings are available up to 40 feet wide with five projection ranges up to 13 feet. The twin PVC coated arm cables and internal cold wound, high carbon arm springs exert almost 900 lbs of outward force in each arm to provide you a superior looking awning that is designed to last.



Use the Following Chart to Determine the Price of Your Motorized Awning*
Find the width and projection of the treatment you will be ordering.
Round up to the nearest width/projection.

		Maximum Projection Of Awning (Feet and Inches)					Hood Option
		6'7"	8'2"	10'0"	11'6"	13'0"	
Maximum Width of Awning (Feet)	9'	1,633					205
	10'	1,658	1,714				223
	11'	1,678	1,803				240
	12'	1,744	1,905	2,043			258
	13'	1,805	1,927	2,073			282
	14'	1,830	1,954	2,107	2,287		297
	15'	1,857	1,985	2,148	2,376	2,575	310
	16'	1,974	2,114	2,236	2,500	2,645	327
	17'	2,004	2,144	2,308	2,562	2,735	352
	18'	2,087	2,236	2,377	2,610	2,796	374
	19'	2,111	2,269	2,406	2,733	2,886	387
20'	2,229	2,360	2,544	2,795	2,986	408	

The optional aluminum, powder-coated SunStopper hood matches the frame color and will greatly reduce the elements from affecting your awning when retracted. The protective hood is highly recommended for all roof mounting and wall mounting applications when no direct overhead protection exists.

Awnings available in widths up to 40'. Please call for a price quote.
[†]Roof-mount brackets carry additional costs.

*** Pricing includes 110VAC RTS motors with manual override, hand crank, 13' plug-in cord, and a single channel hand-held remote.**
Pricing includes mounting hardware.
Pricing valid on all awning fabrics. Browse to www.sunbrella.com/showroom for fabric options.

Awning Accessories

Mood Lighting System

The SunStopper Mood Lighting System is a UL listed, incandescent lighting system that is securely attached to the backside of an Eclipse Awning's front bar. It provides your customer just enough light without overpowering them with brightness or attracting insects. The mood lights can be operated with either an in-line switch or they can be incorporated into a wireless remote control which operates the awning.



Mood Lighting Option - starts at 5' length \$101 base price +\$7/ft.

Infrared Heater

Ideal for outdoor heating of any outdoor living area that may need more warmth for outdoor comfort. This safe, compact, effective and energy efficient heat source allows control of the amount of heat desired at the touch of a button. This 1500 watt heater is available in black or white and can mount either to the awning framework or on a wall. The 15' long heater power cord plugs into an outdoor outlet and has a variable heat controller.



Solar Beam Electric Infrared Heater Option \$456

Drop Shade



The SunStopper Drop Shade option allows you to extend a vertical shade from the front bar up to 39 inches, making it a practical solution for early morning or late afternoon sun exposure. Drop Shades are available in both solid acrylic fabric or in an open weave mesh. This easy-to-operate unit can be driven manually or with a motor, making it another touch of the button solution. Pricing varies greatly, so please contact us for a quote.

Drop Shade Option Varies

Exterior Shades



The SunStopper Zip Screen retractable shading system features high performance fabrics that are secured inside vertical tracks creating a side seal from the outdoor environment.

Please call us or browse to our website: www.worthingtondistribution.com/shades for more details and to request a quote.

**Have a project with AC or DC limit switch motors?
Use these Z-Wave or RS-232 options from Electronic Solutions Inc.**

Z-Wave Motor Control for AC or DC Limit Switch Motors

Electronic Solutions Z-Wave motor control interface provides Z-Wave control of standard limit switch motors. Innovative circuitry allows the interface to provide motor position feedback as well as commands to place the motor in a specific position. Works with all Z-Wave devices that can control lighting.

		MAP \$	Dealer	
ESIDBMZ908	Z-Wave interface for low voltage, 2-wire limit switch motors	217.00	Call	ESI Z-Wave interfaces have MAP price restrictions. Call for your low dealer price.
ESIABMHZ***908	Z-Wave interface for 3-wire AC limit switch motors	259.00	Call	
ESITZ3300908	Z-Wave 5-Channel Remote Control	N/A	85.93	*** = select voltage 115 - 115VAC, 230 - 230VAC

Serial Motor Controllers for AC or DC Limit Switch Motors

Motor control with Electronic Solutions, Inc. is not limited to just controlling window treatments. The line-level RQ interface boards are rated to handle up to 9.8 amps to give you control of motorized projection screens, television lifts, skylights, awnings, and even motorized pool covers. Both the AC and the DC control boards use current sensing to learn the limits of the motor which allows the integrator to send commands to the motor to go to any intermediate position reliably to within 1/16 of an inch with position feedback confirmation through ASCII.

ESIRQBRIDGE	RS-232 or RS-422 Serial Interface. Converts ASCII strings to RQ commands.	56.39
ESIRS232ADAPTER	RS-232 Adapter. Use to connect RS-232 source to the ESIRQBRIDGE.	11.28
ESIJP12	12" Modular Cable. Used to connect the ESIRS232ADAPTER or to connect multiple motor controllers together.	2.15
ESIRQ60AUMH115	4-wire, AC motor control board. For use with line voltage, limit switch motors.	97.00
ESIRQ60DUM	2-wire, DC motor control board. For use with low voltage, limit switch motors.	80.56

Replacing an existing ESI serial motor controller? Order the following parts to simplify your installation.

ESIT24S	24-channel IR Handheld Remote Control. Use to program the address and teach the motor limits to an RQ or RP controller.	38.67
ESIOVERLAY0004	24-channel Overlay for ESIT24S	5.91
ESIRE2FT	IR Receiver with 2' Modular Cable. Plugs into RQ/RP bus to program the replacement motor.	8.59

For installations which require the control of multiple motors, Electronic Solutions, Inc. will mount, pre-wire, pre-program, and label the interface boards within an enclosure based on your specifications. Select any of the RQ motor controllers and accessories above, and add in the correct custom panel based on the number of RQ controllers. Because of the materials and processes used, these enclosures are UL listed.



ESI CUSTOM PANEL

ESICUSTOMPANEL1	UL-Listed Custom Panel for up to 4 RQ or RP Motor Controllers	257.29
ESICUSTOMPANEL2	UL-Listed Custom Panel for up to 8 RQ or RP Motor Controllers	321.62
ESICUSTOMPANEL3	UL-Listed Custom Panel for up to 10 RQ or RP Motor Controllers	450.89
ESICUSTOMPANEL4	UL-Listed Custom Panel for up to 16 RQ or RP Motor Controllers	527.08
ESICUSTOMPANEL5	UL-Listed Custom Panel for up to 20 RQ or RP Motor Controllers	678.83

**Worthington Distribution has access to Electronic Solutions, Inc.'s entire product line.
If you don't see a product listed on this page, please call (800) 282-8864 for pricing and availability.**

ESiRule - Smart Phone Integration with ESI Motor Controllers

ESISMRTPHNEWIFI

ESI's new ESiRule Solution is easy to set up and use. This affordable solution effectively controls your RQ network from your mobile device. This solution bundles all the hardware someone needs to connect and set up a smart phone or tablet in order to control an ESI RQ network through a Wi-Fi configuration or LAN.

ESISMRTPHNEWIFI	Smart Phone Wi-Fi Bundle. Includes: Global Cache WF2SL adapter, RQ Bridge, 12" jumper cable, and an RS-232 adapter.	221.07
ESISMRTPHNELAN	Smart Phone LAN Bundle. Includes: Global Cache IP2SL adapter, RQ Bridge, 12" jumper cable, and an RS-232 adapter.	196.72

See page 47 for more iRule solutions.

ESISMRTPHNELAN

LauchPort - Portable iPad Wall and Tabletop Mount with Inductive Charging



iPad2 PowerShuttle shown on desktop BaseStation (left) and near WallStation (right). Both stations are magnetic to hold the iPad, provide inductive charging, and allow portrait/landscape rotation while docked.

LauchPort is the world's first portable iPad wall docking solution with inductive charging. The LaunchPort for iPad consists of three parts. The Power Shuttle is a low profile case that plugs into the charging port of the iPad. It also has the round inductive charging port on the back. There are two docking options. One is a desktop stand and the other is a wall mount. Both are magnetic to hold the iPad to the base and provide inductive charging to the iPad. The wall mount attaches to a 2-gang wall box. It includes wire and a 1-gang plate that can be cut in above an existing power outlet. The included AC adapter plugs into the outlet and the new plate and powers the charger.

Now Available for iPad 4 and mini!



DAN70167



DAN70141



DAN70142

DAN70181	iPad PowerShuttle - Black, fits iPad4	105.00
DAN70182	iPad PowerShuttle - White, fits iPad4	105.00
DAN70166	iPad PowerShuttle - Black, fits iPad2 and iPad Gen. 3	105.00
DAN70167	iPad PowerShuttle - White, fits iPad2 and iPad Gen. 3	105.00
DAN70175	iPad PowerShuttle - Black, fits iPad mini	99.00
DAN70176	iPad PowerShuttle - White, fits iPad mini	99.00
DAN70171	Travel Stand - Black, tabletop stand	14.00
DAN70172	Travel Stand - White, tabletop stand	14.00
DAN70170	iPad WallStation - Black, everything required to get power from a nearby outlet to the station	140.00
DAN70142	iPad WallStation - White, everything required to get power from a nearby outlet to the station	140.00
DAN70141	iPad Tabletop BaseStation, includes power supply	140.00

ControlMount - iPad/iPod Touch Wall Mount with Power

The Control Mount from iPort is a permanent, flush wall mount for iPad, iPad2, and iPod Touch. It includes all the required mounting hardware as well as everything needed to power the device while mounted. Control Mount includes a white plastic bezel that is textured to allow it to be painted. It offers a very low profile extending from the wall as well as a very thin bezel for an elegant look. Painting the bezel makes it almost disappear on the wall. If you are looking for a way to permanently mount an iPad, Control Mount is your answer.



DAN70093	Control Mount for all iPad models	240.00
DAN70094	Control Mount for all iPad mini	199.00
DAN70092	Control Mount for iPod Touch 4th gen	150.00

IW Series - In-Wall iPod Docks

IW iPod docks from iPort are the industry standard for integration. They are supported by all major integration systems. They send their signals over Cat 5 to the included wall plate that is installed near the system head-end. IW docks are adjustable to fit most models of iPods. They always charge the iPod while it is docked. The included white bezel is paintable to match customers' decor.



DAN70127	IW-20 In-Wall Audio Dock for iPod	120.00
DAN70128	IW-21 In-Wall Audio Dock w/ IR for iPod	240.00
DAN70129	IW-22 In-Wall Audio Dock w/ RS-232 for iPod	360.00

FS Series - Free-Standing iPod Docks

FS iPod docks from iPort are the industry standard for integration. They are supported by all major integration systems. All docks have a USB port for PC connection and will bring up iTunes by pressing the iPort logo button. They all have audio and component video outputs as well.



DAN70115	FS-21 Free-Standing Audio Dock for iPod w/ IR	120.00
DAN70116	FS-22 Free-Standing Audio Dock for iPod w/ RS-232	240.00
DAN70117	FS-23 Free-Standing Audio Dock for iPod w/ on-screen navigation	270.00



iTach Wi-Fi Family of Products

GCWF2IR	Wireless to IR, control IR devices over Wi-Fi, 3 emitters, 1 blaster, power supply	109.91
GCIP2IR	Wired to IR, control IR devices over IP, 3 emitters, 1 blaster, power supply	91.18
GCIP2IR-P	PoE wired to IR, control IR devices over IP, 3 emitters, 1 blaster	117.41
GCWF2SL	Wireless to serial, control serial over Wi-Fi, power supply	109.91
GCIP2SL	Wired to serial, control serial over IP, power supply	91.18
GCIP2SL-P	PoE Wired to serial, control serial over IP	117.41
GCWF2CC	Wireless to contact closure, power supply	109.91
GCIP2CC	Wired to contact closure, power supply	91.18
GCIP2CC-P	PoE wired to contact closure	117.41

Note: iTach Series adapters can have multiple communication sessions



GCIP2IR



GCIP2CC



GCIP2SL



GCWF2IR



GCWF2CC



GCWF2SL

Wirelessly connect, monitor, and control infrared devices over a network and the Internet. The iTach provides flexibility, enabling device networking without wiring. The product is based on open systems and industry standards for easy integration and compatibility.

iTach Flex™ Family of Products

Flex Link Network Interfaces

GCFLEX-IP	Ethernet Flex Link network interface	77.90
GCFLEX-IP-P	Power Over Ethernet Flex Link network interface (being released in 2013)	TBD
GCFLEX-WiFi	Wi-Fi Flex Link network interface	90.89

Note: iTach Series adapters can have multiple communication sessions

Flex Link Cables

GCFLEX-T3	Routed infrared cable for Flex Link: 3 ports	3.21
GCFLEX-BL	Infrared blaster cable for Flex Link	9.70
GCFLEX-SL	Bidirectional serial cable for Flex Link	19.45

Infrared Emitters

GC-BL2	Infrared blaster for the GC-100 and iTach	41.94
GCFLEX-E	Infrared emitter for Flex Link, GC-100 and iTach	3.21

Sensors



GC-SC1

GC-SV1

GC-SP1

GC-SV1	Video Out Sensor: Detects video sync signal on composite or component video out.	41.94
GC-SP1	AC/DC Voltage Sensor: Detects AC/DC voltage 1.5-24V. Optically isolated for circuit protection.	29.95
GC-SC1	Contact Closure Sensor: Detects open and closed status on contacts or devices.	26.95

Infrared Interfaces

GC-IRL	IR Learner: Full spectrum (30 to 500 KHz), used with PC to learn IR codes. Free PC utility software included.	71.92
GC-IRE	IR Extender: Digitizes IR signals from IR receivers to RS232. IR can now be used as input devices.	53.93
GC-RG1	IR Receiver: Capture IR frequencies from 30KHz to 72KHz. Use with GC-IRE.	47.94



GC-RG1

GC-IRL

GC-IRE



GCFLEX-WiFi with GCFLEX-E

GCFLEX-IP



GCFLEX-T3

GCFLEX-BL

GCFLEX-T3

- The iTach Flex is the size of a pack of gum
- Choose from an Ethernet or Wi-Fi configuration
- Add the IR, Routed IR, IR Blaster, or Serial communication cable
- Comes with a mounting plate
- On board web server and memory allow limitless applications and features

GC-100 Network Adapters

GC-100-06	1 male DB9 RS-232, (3) 3.5mm IR output/sensor inputs. Emitters included. 6" unit.	127.36
GC-100-12	2 male DB9 RS-232, 3 relays, (6) 3.5mm IR output/sensor inputs. Emitters included. 12" unit.	239.77
GC-100-18	2 male DB9 RS-232, 3 relays, (6) 3.5mm IR output/sensor inputs. Emitters included. 18" unit.	277.24
GC-100-18R	GC-100-18 with GCRM-18 rack-mount kit	299.72
GCRM-18	Rack-mount kit for GC-100-18, unit sold separately	37.43

Note: GC-100 Series adapters only support single sessions



GC-100-06



GC-100-12

Interface Cables

GC-CGX	Converter: Connects a GC-100 IR output to a Xantech distribution box IR input. Optically isolated for circuit protection. 6 ft, 3.5mm stereo plug.	29.95
GC-CXG	Converter: Connect a Xantech IR output to a GC-IRE for IR digitizing. Optically isolated for circuit protection. 6 ft, 3.5mm stereo plug.	29.95

Audio and Video Extension Cables

GC-CES-06	6ft, 3.5mm stereo extension cable	7.77
GC-CES-12	12ft, 3.5mm stereo extension cable	7.77
GC-CES-25	25ft, 3.5mm stereo extension cable	10.17
GC-CEV-06	6ft, shielded RCA video extension cable	7.77
GC-CES-12	12ft, shielded RCA video extension cable	7.77

iRule Dealer Portal



- Maintain all iRule customers' accounting and projects in a single location
- Add credit to an account by contacting Worthington Distribution or use Paypal directly in the Portal
- Customer's accounts can be activated or deactivated (short term or permanently)
- Contact Worthington Distribution (800-282-8864) to have your iRule Dealer Portal account created

IRUCREDIT Add credit to an iRule account for licenses Varies

iRule Automation Module

Combine Home Theater, HAI and Z-Wave in a Custom Interface



HAI and Z-Wave Lighting



HAI and Z-Wave Temperature



HAI Security

- Home Theater Control
- Lighting: HAI, Z-Wave Vera and Lutron
- HVAC: HAI, Z-Wave, Vera and Lutron
- Locks: HAI and Z-Wave
- Security: HAI

Browse to www.worthingtonu.com or www.iruleathome.com for training

IRUAUTOMATE Add HAI, Lutron, ISY, Z-Wave (via Leviton VRC0P-1LW or Vera), or Radio Thermostat of America Wi-Fi Control to an iRule Handset 25.00

iRule is typically not ordered by part number, add credit to your account

iRule iTunes Module



- Use iTunes as a media server
- Supports Music, Audio Books, Podcasts (both audio and video) and Movies in iTunes
- Use AirPlay to send content to AirPlay compatible devices such as AppleTV and AirPort Express
- Add to an iRule handset in seconds

IRUITUNES Add iTunes Module to an iPad iRule Handset 25.00

iRule is typically not ordered by part number, add credit to your account

Additional iRule Modules

IRUINTEGRA Add Integra Module to an iRule Handset 15.00

IRUSONOS Add Sonos Module to an iRule Handset 25.00

iRule is typically not ordered by part number, add credit to your account

Mobile Device Mounting Solutions



iPort Weighted Table Base



iPort Wall Mount Inductive Charger



See page 45 for the complete line of iPort mounting and charging solutions for iPort



iPort Wall Mount



Custom Interfaces for iOS and Android

and many others.....

IRUPROBUILD iRule Builder License with 5 Handsets, 2-way feedback interfaces, iRule community access, quick device replace, hide the navigation bar 90.00

IRUBASICBUILD iRule Builder License with 3 Handsets 45.00

iRule is typically not ordered by part number, add credit to your account

iRule Builder

- iRule puts the 'Custom' back in 'Custom Integrator'
- Create custom interfaces to control a customer's home theater and include control of automation devices by adding the automation module
- Use Global Cache modules for legacy connections such as infrared, serial, contact closure, and sensor inputs
- Setup and configure projects using a modern web browser
- Projects are stored and configured in the cloud
- Projects can be backed up locally
- Internet connectivity is only needed during setup and configuration changes
- Use built-in wizards for quick configuration or use the iRule Builder to customize a project to meet your customers' interests and life styles
- Graphics, IR code, and IP/Serial protocol libraries are included
- The Pro License gives access to the iRule Community; the ability to publish and use interfaces and device libraries from other iRule users



iRule Handsets



- iRule allows multiple devices in a project to share the same handset interface
- A new handset interface only needs to be created when an interface will be written for a new type of hardware or if the interface is different for a user
- In this example, one Pro License is being used on nine individual devices with five unique interfaces

IRUHANDSET Add a handset to an iRule project 15.00

iRule is typically not ordered by part number, add credit to your account

The BitWise System

Do you want to offer your customers a robust remote control solution on their iPhone, iPad, or Android device? If so, take a look at BitWise Controls. They offer hardware and software that allows dealers to create rich user interfaces that provide intuitive and reliable control of home theater and media devices.



New Feature:
Update your customers' GUI via email - no need to travel to their site.

Visit worthingtonu.com for complete BitWise training.



Control Home Theater and Home Automation from any Web-Enabled Device

BitWise Setup Steps

- Install the BC4 Controller
- Create a new project in the Project Editor software and add the IR and Serial devices to be controlled
- Create macros to launch activities or power the entire system up or down
- Create the user interface. We recommend purchasing the Template Pack to speed this process.
- Assign device codes to buttons in the interface
- Send the interface to the customer's device

BC4 Controller



BC4 Features

- Built-in IR Library
- 4 Zoned IR ports
- Built-in IR blaster
- 2 GPIO (general purpose input/output)
- 2 SPDT relays
- Bi-directional RS-232
- Power via 12VDC or PoE
- Logic (IF INPUT1 is ON, Send Power)

Tip: Don't limit yourself to a single BC4 per job. Add more if more than four IR zones are required, or if you are controlling more than one set of equipment.

Project Editor Software

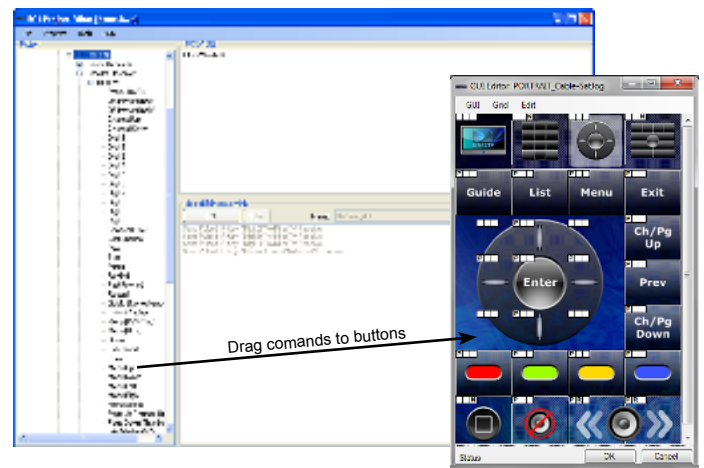

Project Editor is where it all happens. From here, dealers find BC4s on the network, add components, and design or configure GUIs. Devices are easy to add thanks to the comprehensive built-in IR library, but IR learning is possible as well. Whether you design your own GUI or hit the ground running with the template pack, use Project Editor to drag IR codes to the corresponding button. A simple click from here loads your GUI onto the handheld device.

iPhone and iPad Template Pack



C3 Xenon Templates

Blackman Signature Designs Templates

The award-winning Template Pack is a great addition to an installer's toolbox. It offers many advantages. First, it lets you get started right away without having to take the time to design a graphical interface from scratch. It is also a great starting place if you do want a custom interface since you can make any changes desired.

Dealers purchase the Template Pack once, it is not required to purchase one per installation.

Parts

Prices listed are MSRP -
Call or go online for your dealer price.

BITBC4	Controller, IR, serial, Ethernet, GPIO, relay	549.00
BITBD-COMBO	Blackman Signature Designs Template pack for iPhone, iPod Touch, and iPad	499.00
BITBDANDROID	Blackman Signature Designs Template pack for Android	350.00
BITIOSANDROID	Blackman Signature Designs Template pack for all IOS and Android	750.00
BITC3XENONIOS	C3 Xenon Template pack for iPhone, iPod Touch, and iPad	499.00
BITBCIRI	IR to Serial Converter, receives an IR code and converts to serial string, great for initiating BC4 macros	149.00

The BCIRI is a great addition to any BitWise system. It receives an IR code from any standard remote. The BC4 can then initiate macros based on that input. It allows customers to keep their existing remotes in addition to using their iPhone/iPad for control.

Xen 802.11n Wi-Fi Access Points

Luxul Xen™ Makes Any Installer Look Like a Network Technician

More and more home systems include multiple wireless devices: laptops, game systems, smart phones like the iPhone; or increasingly Wi-Fi remotes and Touch Panels. In our wirelessly-connected world, many installers overlook the chance to provide a networking solution. Luxul Xen simplifies Wi-Fi installations with superior coverage, pre-configured and modular solutions, and a wide range of powered-over-ethernet (PoE) access points. Easy to install and manage, with pleasing form factors, every one of your projects should include a Luxul Xen network.

Outdoor 802.11n Wireless Solutions

LUXXAP-1040	Surface-mount, 10,000 square foot directional coverage, great for providing WiFi coverage to an outbuilding by placing two units in bridge mode. PoE compliant (includes PoE injector), includes gimbal mount and weatherproof Cat 5 connector.	449.64
LUXXAP-1050	Same as above, but includes a 30W PoE pass-through. Pair it with an XAP-1040 in bridge mode to connect a PoE IP camera for remote security in outbuildings.	533.95



LUXXAP-1040/1050

PoE IP Camera Solutions from Everfocus

Looking for a camera which is compatible with a Luxul XAP-1050? Check out Everfocus' line of PoE compliant cameras. Their line includes bullet or dome cameras with built-in IR for day or night operation. They also have high resolution cameras, up to 3 megapixel.

See page 115 for more details

Indoor 802.11n Wireless Solutions



LUXXAP-1010



LUXXAP-1020

LUXXAP-1010	Mounts in 2-gang box (included) for a flush appearance, 10,000 square foot coverage, PoE compliant (includes PoE injector)	413.11
LUXXAP-1020	Surface-mount (wall or ceiling), 10,000 square foot coverage, PoE compliant (includes PoE injector)	413.11

Luxul Xenmaster App

A Free Smartphone Application to Simplify Installation of Luxul Xen™ Networking Solutions

Use your iOS, Android or virtually any other smart device to automatically discover and configure Luxul Xen networking devices in minutes. Designed to simplify the network installation process for Luxul Xen installers, Luxul XenMaster gives you easy network setup, intuitive configuration, and access to network performance testing tools.

Using Luxul XenMaster is incredibly simple. Download the app, open it up and all Luxul Xen products will automatically be listed and made available for setup. With just a few taps, you can quickly and efficiently configure an entire residential or commercial network.

Requires Luxul firmware v3.0.0 or later.



LUXXAP-1030



LUXXAP-1032

LUXXAP-1030	Surface-mount metal enclosure, 10,000 square foot omnidirectional coverage, great for placement central to coverage area, PoE compliant (includes PoE injector),	413.11
LUXXAP-1032	Surface-mount metal enclosure, 20,000 square foot directional coverage with dual antennas (10,000 sq ft coverage each), great for L-shaped structures or place central to large structure with antennas facing away from each other, PoE compliant (includes PoE injector)	525.52

Network Backbone Products



LUXXBR-2300



LUXXGS-1008



LUXXGS-1024



LUXXMS-1024



LUXXMS-1008P

LUXXBR-2300	Dual-Wan Router, provides automatic switch- over to secondary provider if primary fails, 3 LAN ports, built-in VPN server, bandwidth control, rack mountable	151.75
LUXXGS-1024	24-port Gigabit Ethernet Switch, unmanaged, rack mountable	210.77
LUXXGS-1008	8-port Gigabit Ethernet Switch, unmanaged, desktop	53.39
LUXXMS-1024	24-port Gigabit Ethernet Smart Switch, XenSmart management, rack mountable	345.66
LUXXMS-1008P	8-port Gigabit Ethernet PoE Smart Switch, XenSmart management, rack mountable. Great for powering Xen access points, HAI OmniTouch 5.7e screens, and more	300.70
LUXXFS-1084P	8 Port Ethernet Switch, 4 ports PoE enabled	73.04

The Case for Sillites

Sillites are an elegant upgrade to any new home. The system is made up of receptacles that install directly into the windowsill and lights that plug into them.

Many homes use welcome lights year-round to create a warm look from the exterior. As the lighting control and automation system installer, you are the perfect contractor to offer Sillites to the homeowner. Instead of window candles that are always on or each have a photocell, you can offer a more intelligent option that is part of the lighting system. Your customers can have the Sillites on a daily or holiday schedule and their lights do not have to be on all night as they would be if using a photocell.



Layout and Installation

The Sillites receptacle is ETL-listed and does not require any back box - it's referred to as the self-contained receptacle (SCR). It is also tamper-resistant to meet all new codes. Its clever design provides two termination points so that each one is a feed-through.

If you are also installing a lighting control system in the home, run the Sillites feeds to a switch or dimmer on the system and you now have full control of them. The switches can be hidden in a closet or utility area.

Even if you are not installing a full lighting system but are providing some type of automation or security system with a scheduling feature, it is still a good idea to have that system control the Sillites.



Pre-Wire



SCR
Wiring

Self-Contained Receptacles

SILSCRW	Self-contained receptacle, white, 125V, 15A & TR rated for use with 12/2 or 14/2 cables	12.94
SILSCRMB	Self-contained receptacle, black, 125V, 15A & TR rated for use with 12/2 or 14/2 cables	12.94
SILSCRBR	Self-contained receptacle, brown, 125V, 15A & TR rated for use with 12/2 or 14/2 cables	12.94
SILRR9W	Remodel receptacle, white, 125V, 15A rated with 9' of 14/2 NM wire attached	16.74



Using the SCR for Window Treatment Installations

The SCR is the ideal prewire solution for powering 110 volt motorized window treatments. It can easily be wired and discreetly installed in the jamb near the top of the window. This allows the treatment to be powered

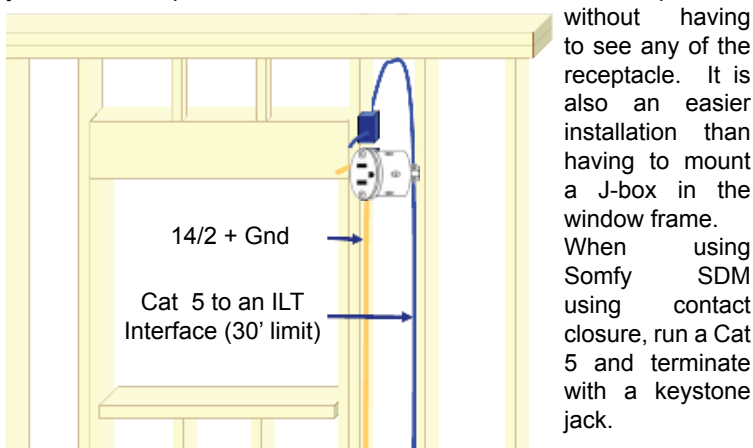

Sillite Candles



The Sillites candles have a base with a standard 3-prong electrical plug in the bottom. This allows them to plug securely into the self-contained receptacle. They are available in two sizes and four finishes.

SILSL7*	7" tall candle with lamp, drip cap, and white PVC sleeve	37.97
SILSL9*	9" tall candle with lamp, drip cap, and white PVC sleeve	43.96

* AB - Antique Bronze, PB - Polished Brass, BN - Brushed Nickel, MB - Matte Black

Candle Sleeves



Beeswax sleeves simply slide over the PVC candlestick that comes with the candles to provide a more classic look. Note: part numbers below are for the beeswax sleeves only and do not include the plug or bulb.

SILGBS7	Golden beeswax sleeve for SILSL7	9.09
SILGBS9	Golden beeswax sleeve for SILSL9	9.09
SILIBS7	Ivory beeswax sleeve for SILSL7	9.09
SILIBS9	Ivory beeswax sleeve for SILSL9	9.09

Stand-Alone Timer



If you sell a Sillites job without lighting control or automation, it's still good practice to wire all the candles back to a timer. The LEVVPT24-1PZ is great for the application. It allows you to set the lights to come on and off based on sunrise and sunset.

LEVVPT24-1PZ	Decora wallbox timer, digital display, dusk-to-dawn function	33.12
--------------	--	-------

ELK PRODUCTS, INC. M1 Gold	ELK PRODUCTS, INC. M1 EZ8	DSC 1832	Simon XT Inferlogix	GO Control 309 technologies	Vera3 greenleaf 3.com	Omni LTE LEVITON Security & Automation	Lumina LEVITON Security & Automation	Omni IIe LEVITON Security & Automation	LuminaPro LEVITON Security & Automation	OmniPro II LEVITON Security & Automation	
Y/Y	Y/Y	Y/Y	Y/Y	Y/Y	Y/Y	Y/Y	Y/Y	Y/Y	Y/Y	Y/Y	Upload/Download
Y	Y	Y	Y	Y	Y	Y	Y	Y	Y	Y	Internet Control
16	16	O 4	Y	4	232	4	4	4	64	64	Thermostats
Y	N	Y	Y	Y	N	Y	N	Y	N	Y	FCC/UL Security
16 (208)	8 (200)	8 (32)	2 (40)	2 (48)	N/A (232)	16 (32)	16 (48)	16 (48)	16 (176)	16 (176)	Zone/Inputs (max)
Y (500+)	N	O (256)	Y (128)	Y (254)	N	Y (550)	Y (550)	Y (550)	Y (550)	Y (550)	Vocabulary (words)
13 (205)	12 (204)	2 (14)	2 (2)	2	O (232)	8 (8)	8 (8)	8 (8)	8 (136)	8 (136)	Outputs (max)
Y	Y	N	Y	Y	O	Y	Y	Y	Y	Y	Touchscreen
16	16	8	5	4	N/A	4	8	8	16	16	# of Consoles
O 48	O 48	O 32	40	48	O 232	O 16 (64)	O 16 (64)	O 16 (64)	O 128	O 128	Max Wireless
Y	Y	N	N	Y	Y	Y	Y	Y	Y	Y	Astronomical Clock
Y	N	O	Y	Y	N	Y	Y	Y	Y	Y	Phone Access
O	O	O	N	N	Y	Y	Y	Y	Y	Y	Ethernet Port
1 (8)	0 (7)	0 (1)	0 (0)	N/A	2 (8)	5	5 (6)	5 (6)	5 (6)	5 (6)	Serial Ports (max)
Y	Y	N	N	N	P	Y	Y	Y	Y	Y	UPB Support
P	P	N/A	Y	Y	Y	Y (4)	Y (4)	Y (4)	Y (16)	Y (16)	Lock Support
Y	Y	N	Y	Y	Y	Y	Y	Y	Y	Y	Z-Wave Support
Y	Y	N	N	N	Y	Y	Y	Y	Y	Y	Vizia-RF+ Support
N	N	N	N	N	P	Y	Y	Y	Y	Y	ZigBee Support

Y=Yes; N=No; O=Optional; P=Pending; N/A=Not Applicable

The information in this chart was gathered from manufacturer websites, tech support and literature. Confirm specs with manufacturer prior to ordering. Worthington Distribution's knowledgeable staff can help with any questions you may have. Call today!

Five Questions when Choosing an Omni Controller

1. How many security points or automation inputs will your installation require?

- Greater than 48 - OmniPro II or Lumina Pro
- 48 or less - Omni Ile, Lumina, OmniPro II, or Lumina Pro
- 16 hardwired (32 with wireless) or less - Omni LTe



2. Will you be connecting to a third party distributed audio system such as Russound, Xantech or Proficient?

- Yes - OmniPro II or Lumina Pro



3. How many thermostats will your project require?

- Greater than 4 - OmniPro II or Lumina Pro
- 4 or less - Any of the controllers



4. How much lighting will your project require?

- Greater than 64 loads/8 rooms - OmniPro II or Lumina Pro
- 64 loads/8 rooms or less - Omni Ile, Lumina, OmniPro II, or Lumina Pro
- 32 loads/4 rooms or less - Any controller



5. Does your project require security in the controller?

- Yes - Omni LTe, Omni Ile, or OmniPro II
- Using DSC Power Series security - Lumina or Lumina Pro
- A security system other than DSC Power Series is installed - Omni LTe, Omni Ile, or OmniPro II

Connectivity Partners

Connectivity Partners	Products	Page	
Irrigation	WGL & Associates	Rain 8	187
	Leviton	Vizia rf +: Z-Wave	12-13
Lighting	CentraLite	JetStream, Elite XL	32-34
	PCS	Pulseworx	28-29
	Lutron	RadioRA 2	20-27
	Cooper	Aspire RF: Z-Wave	16
	GE and Jasco	Z-Wave Devices	15
	Evolve	Z-Wave Devices	14
	Simply Automated	UPB Devices	30
Interfaces	iRule	Customizable Interfaces for iOS and Android	70, 71, 47
Large Load Control	RCS	Z-Wave 30 Amp Contactor	17
Access Control	Seco-Larm	Deadbolts, Magnetic Locks, Door Strikes	107
	GE	Wireless Devices	96
Communicating Locks	Kwikset & Baldwin	Deadbolts and Entry Sets: Z-Wave and ZigBee (Kwikset only)	10
	Yale	Deadbolts and Entry Sets: Z-Wave and ZigBee	11
	Schlage	Deadbolts and Entry Sets: Z-Wave	11
Security	DSC	Power Series	91
Wireless Sensors	Ion	Wireless transmitters compatible with the LSA42A00-2 GE Receiver	60, 99
	Resolution Products	Wireless transmitters compatible with the LSA42A00-2 GE Receiver	60, 99
Wireless Networking	Luxul Wireless	Enhanced antenna solutions for Wi-Fi access points	49
Water Detection	Winland	Waterbug	104
	GRI	Water Sensor	103
Water Shutoff	GreenField Direct	KZValve	72
Structured Wiring	Leviton	Leviton Integrated Networks	164-168
	Legrand	OnQ and Greyfox	
Whole House Audio	Russound	MCA-C5, MCA-C3, CAA66, CAS44, CA4	119-122
	Proficient	M4, M6	132
Window Coverings	Somfy	Controls / Motors for window treatments featuring Z-Wave	169-175
	ESI	Motor Controls	44
	Lutron	Motorized honeycomb shades controlled by RadioRa 2	26-27
Vehicle Detection	Cartell	Vehicle Detection Probes	82
	Dakota Alert	Hardwired and Wireless Sensors	83
Pool / Spa	Jandy	Aqua-Link	72
Temperature Control	RCS - Z-Wave	RCSTZ45 thermostat	18
	Evolve	EVOT-100R thermostat	18
	2GIG	2GIG-Z-CT100 thermostat	18
	Trane	SCHTZMT400 thermostat	18
	Honeywell	YTH8320ZW thermostat	18



Russound, Proficient, Xantech, Audio Integration	Yes	No	No	Yes	No
Hi-Fi 2 Audio Integration	Yes	Yes	Yes	Yes	Yes
Communicating Thermostats	64	4	4	64	4
Inputs - On Board / With All Expansion	16 / 176	16 / 48	16 / 32	16 / 176	16 / 48
Voltage Outputs - On Board / With All Expansion	8 / 136	8 / 8	8 / 8	8 / 136	8 / 8
Consoles	16	8	4	16	8
Supported IP Touchscreens (5.7e, OmniTouch Pro)	16	16	16	16	16
Serial Ports - On Board / With All Expansion	5 / 6	5 / 6	5 / 6	5 / 6	5 / 6
Flash Firmware Upgrade	Yes	Yes	Yes	Yes	Yes
Ethernet Port	Yes	Yes	Yes	Yes	Yes
2-Wire Smoke Loops *	4	4	4	No	No
User Codes	99	16	16	99	16
Access Control Cards / Keytags	99	16	16	99	16
Access Control Readers	16	4	4	16	4
ZigBee and Z-Wave Lock Support	16	4	4	16	4
Programming Lines	1500	500	300	1500	500
Vocabulary	550	550	550	550	550
Custom Vocabulary	Yes	No	No	Yes	No
Maximum Auxiliary Current	1 Amp	1 Amp	1 Amp	1 Amp	1 Amp
Maximum Bell Current	1 Amp	1 Amp	1 Amp	1 Amp	1 Amp
Driver Support for DSC Power Series	No	No	No	Yes	Yes
UL Listed for Residential Burglary and Fire	Yes	Yes	Yes	No	No
Reporting Formats: Contact ID, 4/2, 3/1	Yes	Yes	Yes	No	No
Removable Terminal Strips	Yes	Yes	Yes	Yes	Yes
Warranty	3 years	2 years	2 years	3 years	2 years

Lighting Options and Capacities

UPB	Home Lighting Control (HLC)	31 Rooms**	8 Rooms**	4 Rooms**	31 Rooms**	8 Rooms**
	Simply Automated - Simply Brilliant	256 Addresses	64 Addresses	32 Addresses	256 Addresses	64 Addresses
	PCS - Pulseworx	256 Addresses	64 Addresses	32 Addresses	256 Addresses	64 Addresses
Z-Wave	Leviton - Vizia RF + (2-Way)	30 Rooms**	8 Rooms**	4 Rooms**	30 Rooms**	8 Rooms**
	Standard Z-Wave	64 Devices	64 Devices	32 Devices	64 Devices	64 Devices
Zigbee	Centralite - JetStream	200 Devices	64 Devices	32 Devices	200 Devices	64 Devices
	ZigBee Plug-In Modules	256 Addresses	64 Devices	32 Devices	256 Addresses	64 Devices
Lutron	RadioRA	64 Devices	64 Devices	N/A	64 Devices	64 Devices
	RadioRA 2	200 Device	64 Devices	N/A	200 Devices	64 Devices
X10	Leviton DHC, ACT	256 Addresses	64 Addresses	32 Addresses	256 Addresses	64 Addresses
Hardwired	Omni-Bus	192 Devices	64 Devices	32 Devices	192 Devices	64 Devices
	KNX Interface	192 Devices	64 Devices	32 Devices	192 Devices	64 Devices
	Centralite Elegance XL	192 Devices	64 Devices	32 Devices	192 Devices	64 Devices
	Schneider Electric C-Bus	256 Devices	64 Devices	32 Devices	256 Devices	64 Devices

* Worthington recommends wiring for 4-wire smokes with Omni controllers.

** A Room = 8 devices (Programming on the 8s). The controller tracks devices in a room and offers room status in addition to individual device status.

OmniPro II

- "Top Dog" of Omni controllers
- Hi-Fi 2, Russound, Xantech, and Proficient Distributed Audio Support
- Integrated Ethernet port for connectivity
- Expandable for up to 176 security / automation points
- Plug and play with Omnistat thermostats
- Full support for numerous lighting systems
- Ethernet access using Snap-Link, PC Access or WebLink II
- Up to 6 serial ports for integration with third party systems

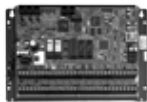

The OmniPro II and Lumina Pro offer the greatest number of third party drivers



LSA20A00-2***	OmniPro II controller in enclosure, RJ-31x, manuals, lock, keys, requires 7Ah battery, 24/40VA transformer	1262.11
LSA20A00-8***	OmniPro II controller on a Leviton, Open House, Legrand, and UStec structured wiring plate, RJ-31x, manuals, wiring diagram decal, requires 7Ah battery, 24/40VA transformer	1262.11
LSA20A00-5	OmniPro II commercial controller in an enclosure, RJ-31x, manuals, lock, keys, requires 7Ah battery, 24/40VA transformer	1367.02
LSA20A00-21***	OmniPro II controller board only (order resistors separately), requires 7Ah battery, 24/40VA transformer	1209.47

*** See note at the bottom of the page for language options

Worthington Distribution OmniPro II Packages



LSAKIT15



LSAKIT15S

LSAKIT15 OmniPro II in Enclosure Kit 1479.99

OmniPro II controller in enclosure, 16 zone expander, surface-mount console, flush-mount kit, temperature sensor, serial cable, RJ-31x, manuals, lock and key, **includes free transformer and battery!**

1479.99

LSAKIT15S OmniPro II for Structured Wiring

OmniPro II controller on a Leviton, Open House, Legrand, and UStec structured wiring plate, 16-zone expander, surface-mount console, flush-mount kit, temperature sensor, serial cable, RJ-31x, manuals, **includes free transformer and battery!**

Lumina Pro

- A Lumina Pro is an OmniPro II with security features removed
- Instead of arming and disarming, Lumina offers automation modes
- The Lumina Pro typically does not require a security installation license
- To integrate security with a Lumina, add a DSC PowerSeries™ panel using a DSC PC5401 or DSC IT-100 serial interface (page 91) and an LSA36A05-4 serial cable
- Lumina controllers ship with a console, transformer and battery

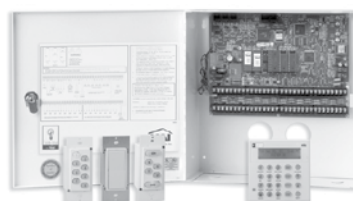

LSA38A04



LSA33A00-19

LSA44A00-2	Lumina Pro in enclosure, LCD console, UPB PIM, coupler, cable & manuals	841.05
LSA44A00-4	Lumina Pro on a Leviton, Open House, Legrand, and UStec structured wiring plate, LCD console, UPB PIM, coupler, serial cable & manuals	841.05
LSA44A00-22***	International Lumina Pro in enclosure, LCD console, serial cable, manuals	1051.39
LSA44A00-23***	International Lumina Pro on a Leviton, Open House, Legrand, and UStec structured wiring plate, LCD console, serial cable, manuals	1051.39

*** See note at the bottom of the page for language options

Lumina and Lumina Pro Accessories

LSA33A00-19	Lumina 20-button LCD console	128.46
LSA33A00-20	Lumina 20-button LCD console, w/ speaker & mic	154.00
LSA33A00-25	International Lumina 20-button LCD console	124.89
LSA33A00-26	International Lumina 20-button LCD console, with speaker and microphone	154.00
LSA33A00-3	Flush-mount kit for LSA33A00-19 & LSA33A00-20	21.00
LSA38A00-3	Mode control keypad	135.79
LSA38A04*	6-button mode controller keypad color change kit	3.23
LSA1111	Lumina Programming Software	47.37
LSA44A01-1	Lumina Telephone connection interface: RJ-31x	16.58

*-WH-White, LTA-Light Almond, IV-Ivory, AL-Almond, BL-Black, BR-Brown, GR-Gray

Miscellaneous Accessories

At Worthington, we understand how important it is to have the right equipment in the field. We recommend adding a self-resetting transformer, 7Ah backup battery and interior and exterior sounder to your Omni controller.

ELKTRG2440	Transformer, 24VAC, 40VA, auto-resetting, grounded, use with OmniPro II & 17A00	14.14
UB1270	Battery, rechargeable, 12V, 7Ah	12.79

*** Other Languages are available, call for pricing: SPA = Latin American Spanish, SPE = European Spanish, IT = Italian, CAT = Catalan, FR = French, CHT = Traditional Chinese, CHS = Simplified Chinese, GER = German, POR = Portuguese, AR = Arabic, HE = Hebrew, RU = Russian

Lumina

- A Lumina is an Omni Ile with security features removed
- Instead of arming and disarming, Lumina offers automation modes
- The Lumina typically does not require a security installation license
- To integrate security with a Lumina, add a DSC PowerSeries™ panel using a DSC PC5401 or DSC IT-100 serial interface (page 91) and an LSA36A05-4 serial cable
- Lumina controllers ship with a console, transformer and battery



LSA44A00-1	Lumina in enclosure, LCD console, UPB PIM, coupler, cable & manuals	630.53
LSA44A00-3	Lumina on a Leviton, Open House, Legrand, and UStec structured wiring plate, LCD console, UPB PIM, coupler, serial cable & manuals	630.53

See the Lumina Pro section for keypads, software and additional consoles

Lumina Integration with DSC

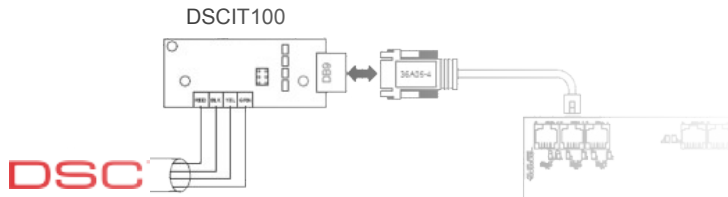

Connect the RJ11 end of the serial connectivity adapter (LSA36A05-4) to a serial port on the Lumina/Lumina Pro (LSA44A00-1 or LSA44A00-2). Connect the DB9 end of the LSA36A05-4 to the DSC serial adapter (DSC PC5401 or IT-100 - page 91). Connect the DSC PC5401 or DSC IT-100 to the keypad bus of the DSC PowerSeries™ panel.

Omni LTe

- Integrated Ethernet port for connectivity
- Hi-Fi 2 by Distributed Audio Support
- Expandable for up to 32 security / automation points
- Plug and play with Omnistats
- Full support for numerous lighting systems
- Ethernet access using Snap-Link, PC Access or WebLink II
- Up to 6 serial ports for integration with third party systems



LSA20A00-70	Omni LTe controller in enclosure, RJ-31x, manuals, lock, keys, requires 7Ah battery, 24/40VA transformer	457.80
LSA20A00-72	Omni LTe controller on a Leviton, Open House, OnQ, and UStec structured wiring plate, RJ-31x, manuals, wiring diagram decal, requires 7Ah battery, 24/40VA transformer	457.80
LSA20A00-73	Omni LTe controller board only, requires 7Ah battery, 24/40VA transformer	430.26

Miscellaneous Accessories

ELKTRG2440	Transformer, 24VAC, 40VA, auto-resetting, grounded, use with OmniPro II & 17A00	14.14
ELK1280	Battery, rechargeable, 12V, 8Ah	26.49

Omni Ile

- The workhorse of the Omni family. Excellent value!
- Hi-Fi 2 by Distributed Audio Support
- Integrated Ethernet port for connectivity
- Expandable for up to 48 security / automation points
- Plug and play with Omnistats
- Full support for numerous lighting systems
- Ethernet access using Snap-Link, PC Access or WebLink II
- Up to 6 serial ports for integration with third party systems

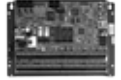

The Omni Ile features an Ethernet Port and support for Hi-Fi 2 Distributed Audio

LSA20A00-50	Omni Ile controller in enclosure, RJ-31x, manuals, lock, keys, requires 7Ah battery, 24/40VA transformer	768.16
LSA20A00-52***	Omni Ile controller on a Leviton, Open House, OnQ, and UStec structured wiring plate, RJ-31x, manuals, wiring diagram decal, requires 7Ah battery, 24/40VA transformer	768.16
LSA20A00-53***	Omni Ile controller board only (order resistors separately), requires 7Ah battery, 24/40VA transformer	735.76

*** See note at the bottom of page 54 for language options

Worthington Distribution Omni Ile Packages



LSAKIT12ES



LSAKIT12ES

LSAKIT12E Omni Ile in Enclosure Kit 934.99
Omni Ile controller in enclosure, surface-mount console, flush-mount kit, temperature sensor, serial cable, RJ-31x, manuals, lock and key, **includes free transformer and battery!**

LSAKIT12ES Omni Ile for Structured Wiring 934.99
Omni Ile controller on a Leviton, Open House, OnQ, and UStec structured wiring plate, surface-mount console, flush-mount kit, temperature sensor, serial cable, RJ-31x, manuals, **includes free transformer and battery!**

OmniStat Thermostats



- An important addition to any Omni installation
- Available in single stage, heatpump or mult-stage
- Humidification and de-humidification options
- Hardwire communication or use the ZigBee HA version for wireless communication

LSARC1000WH	Thermostat: conventional single stage, heat pump and dual fuel systems	149.62
LSARC2000**	Thermostat: conventional 2 stage, 3 stage heat pump, dual fuel systems, humidity and dehumidification	197.49

** -BL-Black, SL-Silver, WH-White

See the complete listing of Omnistats on page 61

4-Wire Smoke Detection (12VDC 4-wire smoke loop)

ESL541NBXT	4-wire smoke, fixed temp & rate-of-rise heat	35.77
ESL541NCSXT	4-wire smoke, fixed temp, rate-of-rise & sounder	39.77
ESL541NCSXTE	4-wire, smoke, heat, sounder, & end-of-line relay	41.84

4-Wire Smoke Detection Accessories

ESL405-05	4-wire, Polarity Reversal Module, forces all 4-wire smokes with sounders to sound	24.51
ESL204-12/24V	4-wire Smoke Loop Power Supervision Relay	12.47



SEN5815NT ESL Smoke Detectors ESL281 SEN5820A-W

2-Wire Smoke Detection (12VDC 2-wire smoke loop)

ESL511C	2-wire basic smoke detector	23.18
ESL521BXT	2-wire smoke, fixed temp & rate-of-rise	26.35

Heat Detection (12VDC systems, 4-wire loop)

ESL104-13	Heat detector - 135°, fixed temp & rate-of rise Great for Kitchens	8.66
ESL282B-PL	Heat detector - 194°, fixed temp & rate-of rise Great for an Attic	Call
ESL104-15	Heat detector - 135°, fixed temp Great for a Garage	8.66
ESL284B-PL	Heat detector - 194°, fixed temp Great for a Furnace Room or Desert Garage	7.18

Glass Break Sensors (12VDC, 4-conductor wire)

SEN5812NT	ShatterPro 3 glass break, form A, rectangular	26.22
SEN5815NT	ShatterPro 3 glass break, form C, round	29.13
SEN5820A-W	ShatterPro II, 1" recessed mount glass break	38.02

CO and Gas Detection

ESL260-CO	"Safeair" carbon monoxide detector with test/hush	54.81
MCGD2A	Combustible gas detector, 12 or 24V, 2 relays	101.14

Water Sensor

GRI2600	Powered (4 wires) water sensor. Uses 12VDC Aux and wires into a zone loop	12.38
GRI2600T	Powered (4 wires) water sensor with 2 probes. Uses 12VDC Aux and wires into a zone loop	19.93

Occupancy

SNCM-9-R	12VAC/VDC Occupancy Sensor, 30 seconds to 20 min., SPDT relay, 13mA draw	82.43
----------	--	-------

Vehicle Detection

Annunciation Options
 • Post a Keypad Message
 • Add an ATW Sounder

ATWPB-005

Out 1 GND

Enhance your automation installation with Vehicle Detector.

Hardwired - Cartell page 82
 Wireless - Dakota Alert page 83
 Leviton Wireless - page 60

+12VDC GND Z+ Z-

Magnetic Contacts

SEN1058-N	1/4" recessed contact, 12" lead, 1/2" gap, NC	4.15
SEN1125W-N	3/8" recessed contact, 12" lead, 3/4" gap, NC	1.26
SEN1075W-N	3/8" recessed contact with terminals, 1/4" gap, NC	2.12
SEN1085T-N	Surface-mount contact, terminals, 3/4" gap, NC	1.21
SEN1085W-N	Surface-mount contact, terminals, 1/2" gap, NC	4.37
GRI7377-W	3/8" stubby with terminals and 1K resistor for use with Omni Controllers, 3/4" gap. 1 per zone loop	3.81
SEN1078CW-N	Recessed 3/4" steel door con, leads, 3/4" gap, NC	6.73
SEN2315A-L	Overhead Door Contact, Form A (normally open)	26.29
SEN2505A-L	3" surface mount contact for overhead doors and fences, normally closed	22.01



SEN2315A-L: In many homes a customer would like to know if the garage door is down when they go to bed. Use the SEN2315A-L and wire into a zone. Include in the night mode a message if the garage door is left open.



Speed up installations by using the GRI7377-W with a built-in EOL resistor. Each contact contains a built-in 1K resistor and screw terminals. Simply attach 2-conductor wire to the contact and connect the other side of the wire to the Omni Zone terminals. The loop is correctly supervised for a professional installation.

Motion Detectors (12VDC, 4-conductor wire)

SEN6540UPI	PIR, 30 lb pet, NC, 40' x 90°	10.22
SENAP100PI	Mirror Optic PIR, 44 lb pet, NC, 33' x 90°	12.02
SEN6255FM-W	Sureshot Flush mount PIR, NC, 30' x 90°	39.13
SENRCR-PET	Range controlled radar PIR, 80 lb pet immune, form A	29.63
SEN6550U	Sharpshooter fresnel lens PIR, form C	11.72
SENAP669	Ceiling-mount dual element PIR 60' diameter, form C	89.50
OXLX402	Outdoor PIR motion detector, form C relay	79.94



ESL260-CO SENAP100PI SEN6255FM OXLX402 SEN6540UPI

Sounders and Strobes

MPMPI-47	Surface-mount sounder: 175mA, 106dB	16.90
MPMPI-47B	Wall-mount sounder: 175mA, 106dB	11.24
MPMPI-47C	Ceiling-mount sounder: 175mA, 106dB	11.24
MPMPI-47E	Enclosure-mount sounder: 175mA, 106dB	11.24



MPMPI-47 MPMPI-47B MPMPI-47E MPMPI-47C ATWDOBERMAN

ATWDOBERMAN	Surface-mount sounder and strobe, 180mA, 105dB, 90mA strobe only	16.61
-------------	--	-------

The maximum sounder output for Omni and Lumina controllers is 1 Amp for interior and exterior outputs combined.

Zone Expansion



Hardware		Zones	Outputs
	Main Controller *	1 - 16	1 - 8
10A06	16 Zone Expander - up to 2	17 - 48	N/A
45A00-1	64 Transmitter Receiver: up to 2	49 - 176	N/A
42A00-2	64 Transmitter Receiver: up to 2	49 - 176	N/A
17A00	16 Zone, 16 Output Expansion enclosures up to 8. Requires battery, transformer	49 - 176	9 - 136



Hardware		Zones	Outputs
	Main Controller*	1 - 16	1 - 8
10A06	16 Zone Expander - up to 2	17 - 48	N/A
45A00-1	64 Transmitter Wireless Receiver	33 - 48	N/A
42A00-2	64 Transmitter Wireless Receiver	33 - 48	N/A



Hardware		Zones	Outputs
	Main Controller*	1 - 16	1 - 8
45A00-1	64 Transmitter Wireless Receiver	17 - 32	N/A
42A00-2	64 Transmitter Wireless Receiver	17 - 32	N/A

* Zone 15 is often the outdoor temperature sensor. Output 8 and Zone 16 are used for thermostat communication. Zones 1-4 can be used for 2-wire smokes. Worthington recommends 4-wire smoke detectors starting on Zone 5. 4-wire smokes can be wired to all 48 zones.



Wireless receivers and transmitters are available on page 60

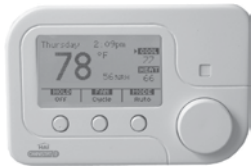

Thermostats - page 61

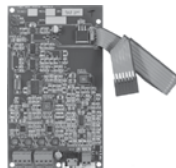

LSA10A11

Popular Add-on Items

ATWBLOODHOUND	Flush-mount sounder, 90mA, 104dB	8.99
ATWDOBERMANPLUS	Piezo siren with strobe, surface-mount, outdoor, 104dB, 180mA	17.36
LSARC1000WH	Thermostat: conventional single-stage, heat pump and dual fuel systems	149.62
LSARC2000WH	Thermostat: conventional 2-stage, 3-stage heat pump, dual fuel systems, with humidity	197.49
LSA31A00-7	Enhanced Extended Range Indoor/Outdoor Temperature Sensor with bracket	46.32
LSA31A00-8	Enhanced Extended Range Indoor/Outdoor Temp/Humidity Sensor with bracket	89.49
LSA10A11	2-way Voice Board	98.50
LSA36A05-4	RJ-11 to DB-9M connectivity cable. Use with Russound, Lutron, RadioRA 2, Jandy & Centralite.	9.47

Zone Expanders

LSA10A06	16-zone expansion module with accessory kit, maximum of 2 per OmniPro II, Omni IIe, Lumina or Lumina Pro system. For zones 17 - 32 and zones 33-48	98.75
LSA17A00	16-zone/16 output expansion enclosure, lock and key, max 8 per OmniPro II or Lumina Pro system, requires 7Ah battery, 24/40VA transformer	248.67
LSA17A00-9	16-zone/16 output expansion on a Leviton, Open House, Legrand, and UStec structured wiring plate, max 8 per OmniPro II or Lumina Pro, requires 7Ah battery, 24/40VA transformer	262.44
LSA17A00-8	16-zone/16 output expansion board only, max 8 per OmniPro II or Lumina Pro system, requires 7Ah battery, 24/40VA transformer, no mounting hardware included	226.67



LSA10A06

LSA17A00

LSA17A00-9

Expansion Enclosure Battery and Transformer

ELKTRG2440	Transformer, 24VAC, 40VA, auto-resetting, grounded, use with all controllers & 17A00	14.14
ELK1280	Battery, rechargeable, 12V, 8Ah	26.49

System Consoles

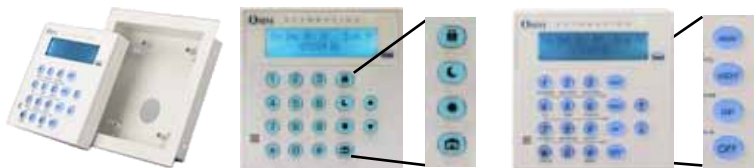

LSA33A00-1 with LSA33A00-3

International Versus Traditional Icons

LSA33A00-1	LCD surface-mount console, silk-screen front	119.29
LSA33A00-23	International version of the LSA33A00-1: uses icons instead of text on the arming buttons	128.46
LSA33A00-4	LCD surface-mount console with speaker and microphone, silk screen front, connector kit	151.58
LSA33A00-24	International version of the LSA33A00-4: uses icons instead of text on the arming buttons	154.00
LSA33A00-3	Flush-mount kit for LCD keypads	21.00

2-Way Voice

LSA10A11	2-way Voice Board: Features a line level output and relay. Includes a 12VDC trigger for speech over a Russound CAV6.6, MCA-C5, or Hi-Fi 2.	98.50
LSA28A00-1	Speaker and microphone for 10A11, surface-mount enclosure, maximum 2 per installation	25.00
LSA28A00-2	Speaker and microphone for 10A11, flush-mount enclosure, maximum 2 per installation	21.05

Custom Interfaces On a PC - Automation Studio



Software



Audio Source



Russound E/C Interface

Automation Studio is design software which allows dealers to create and modify the interface on third party PCs running OmniTouch Pro Software. Within the software are basic programming elements used to modify Omni's base template. There is no scripting required. The entire customization process is drag and drop. Automation Studio allows dealers to add JPEG image feeds from IP cameras or DVRs. For A/V control, add the Home Theater Extender (LSA86A00-2) to a project and assign IR commands to buttons. With Automation Studio, Leviton has closed the gap between them and the top end systems in the marketplace. For more information on Automation Studio, please view our free training on www.worthingtonu.com.



LSA1126	Automation Studio configuration software	209.47
LSA1131	OmniTouch Pro Software - software which allows Automation Studio to work with third party touchscreens - XP, Vista, Win 7	62.11

Home Theater Extender 2 (HTX2)



- Provides Home Theater control from the iOS SnapLink Interface
- Control Home Theater devices from touchscreens using Automation Studio software (LSA1126)
- Built in RS-232 serial, (2) I/O ports, (2) relays, (4) Infrared (IR) outputs, and an IR learning port
- Power via the supplied power supply or Power over Ethernet (POE)
- Includes a built-in A/V Library containing over 300,000 IR codes
- Omni graphic templates are included



- When the HTX2 is used with SnapLink Mobile for iOS a new Remote Control icon appears
- Pressing the new icon jumps to the interface created in the HTX2 Mobile Design Software (included)
- A 'back button' feature allows the user to jump back to SnapLink mobile

LSA86A00-2	HTX2 power supply & 4 IR flashers	576.89
LSA62A08-1	IR Flasher with 6' cord	9.82

Wall-Mounted iPad Solutions



iPort Weighted Table Base



See page 45 for the complete line of iPort mounting and charging solutions for iPort



iPort Wall Mount Inductive Charger



iPort Wall Mount

- Mobile devices such as the iPad offers installers and customers an endless supply of apps for home control
- Mounting solutions from iPort provide elegant portable or permanently mounted solutions for the iPad
- The inductive wall-mounted base combined with the table top base gives customers the option to store the iPad on the wall or on a table
- The iPort wall-mount system permanently mounts an iPad to a wall allowing dealers to take advantage of a Retina quality screen combined with iPad apps to create an exceptionally high value wall-mounted touchscreen

Custom Interfaces for iOS and Android



See page 47 and 72 for more information and pricing for iRule with Omni controllers

- iRule puts the 'Custom' back in 'Custom Integrator'
- iRule is compatible with iOS and Android devices
- Simply drag and drop Leviton Security and Automation icons to control lighting, HVAC, security and locks

Create custom interfaces to control a customer's home theater A/V devices, and seamlessly include control of Leviton Security and Automation lighting, HVAC, access control, and security. Building the interface is completely drag and drop.

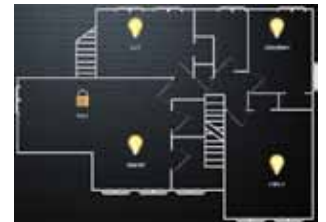

Floorplan Layout



Lighting



Security



Temperature

IRUPROBUILD	iRule Builder License with 5 Handsets, 2-way feedback interfaces, iRule community access, quick device replace, hide the navigation bar	90.00
IRUAUTOMATE	Add HAI, Lutron, ISY, Z-Wave (via Leviton VRC0P-1LW or Vera), or Radio Thermostat of America Wi-Fi Control to an iRule Handset	25.00

iRule is typically not ordered by part number, add credit to your account

Project "Notifier"



Leviton Security and Automation controllers are known for their flexibility and rock solid reliability. One feature that is requested regularly is an add-on solution that will allow a home owner to be e-mailed based on specific activities in the controller. At press time Worthington Distribution is working towards a solution. Please give us a call for pricing and availability.

Leviton Security and Automation Video Storage Server



**Coming in
2013**

The Video Storage Server features real time monitoring with local recording and playback. It has a built-in web server and network interface that is used for monitoring real time high resolution video, scheduling, searching, and playing recorded video. The Video Storage Server is designed to work with the OmniTouch 7 Touchscreen and composite analog cameras.

Specifications:

- 4-channel D1 high resolution digital video recorder
- Compact – Fits into a Leviton Structured Media Enclosure
- High Resolution Video: D1 (720 x 480) at 120 Fps
- H.264 Video Compression
- Real Time Monitoring with Local Recording and Playback
- Supports PTZ (Pan/Tilt/Zoom)
- Built-in Web Server and Network Interface
- Pentaplex Operation: Live, Playback, Record, Archive, and Remote
- Alarm Inputs and Output; BNC and VGA outputs; 2 USB
- Recording: Manual, Continual, Schedule, Motion, and Alarm
- Supports up to 2TB HDD

LSA68A00-2 Video Storage Server TBD

* Specifications and images were not finalized at press time, final images and specification are subject to change

Power over Ethernet (PoE IEEE 802.3af)



Model	Description	Price
LSA90A00-1	PoE Injector: Use with the OmniTouch 7	51.73
LUXXFS-1084P	8 Port Ethernet Switch, 4 ports PoE enabled	73.04
LSA91A00-1	8 Port (8 PoE) 10/100 Mbps Ethernet Switch	251.12
LSA91A00-2	8 Port (8 PoE) 10/100 Mbps Ethernet Switch on a Leviton, Open House, Legrand, and UStec structured wiring plate	314.66

Touchscreen Battery Backup

• When using an IP touchscreen for security, the entire network chain from the router to the controller and the touchscreen, must be on battery backup

TRLBC350	UPS 350VA, 180 watts, 3 UPS supported outlets; 3 surge only outlets	50.58
TRLAV550SC	Structured Wiring UPS 550VA, mounts in can or on a wall. Regulated 12VDC output for 4 devices, 4 110VAC outlets.	147.38

OmniTouch 7 In-Wall Touchscreen

The new capacitive touch glass-front Touchscreen from Leviton Security & Automation. Features a 7" diagonal viewing area high resolution screen for control of your security, energy, and entertainment settings. No setup required other than entering the automation controller's IP address and adjusting the port and encryption keys. Designed for the OmniPro II, Omni IIe, Omni LTE, Lumina Pro, and Lumina automation systems.

New 7" In-Wall Touchscreen For Leviton Security and Automation Controllers



Home Screen



Lighting



IP Cameras



Temperature Control

Specifications:

- Large 7" diagonal viewing area with minimal black or white surround
- Glass-front high resolution capacitive touchscreen
- Modern, easy to use interface with swipe capability
- PoE connection provides all power and communication
- Optional 12VDC power can be used if not utilizing PoE
- Firmware updates via Ethernet
- 2 watt mono digital amplifier and speaker
- Two digital MEMS microphones for improved noise and echo cancellation
- Light sensors allows automatic dimming of display backlight
- An installation which features the OmniTouch 7 Touchscreen must contain a standard LCD console

LSA99A00-* Ethernet-enabled 7" PoE In-Wall Touchscreen 525.08
(*1 - White, 2 - Black)

LSA99A10-1 Trim kit for replacing a 5.7, 5.7e or 3.9 touchscreen TBD

* Specifications and images were not finalized at press time, final images and specification are subject to change

Mobile SnapLink Compatible DVRs



- EverFocus DVRs are compatible with Leviton touchscreens, SnapLink (iOS and Android), iRule, and OmniTouch Pro
- EverFocus includes a free DDNS service
- Simultaneous live, recording, playback, archiving and remote viewing
- Built-in web interface with live view, playback and configuration
- Adding an EverFocus DVR to Automation Studio or a mobile interface is the same
- Confirm Mobile viewer is enabled in the DVR
- Choose 'Add a Camera'
- Enter the user name and password
- Camera URL: http://xx.xx.xx.xx/m/camera1.jpg change "camera1.jpg" for additional cameras
- Change the camera type to jpeg

EFECOR2644D2500 4-Channel, 500GB, 120 FPS, DVD burner 312.25

EFECOR2648D21T 8-Channel, 1TB, 240 FPS, DVD burner 562.05

See page 112 for more EverFocus ECOR DVRs

Supervised Wireless

LSA45A00-1	64 Transmitter wireless receiver, compatible with transmitters	131.53
LSA46A00-1	3-zone door and window transmitter, mercury tilt switch for garage doors, supports remote sensor	38.68
LSA48A00-1	Wireless 4-button keyfob, each button is learned as a separate zone and can be assigned any function	36.47
LSA69A00-1	Wireless 4-button keypad, each button is learned as a separate zone and can be assigned any function	54.74
LSA63A00-1	Wireless driveway sensor	186.42
LSA56A00-1	Wireless recessed door contact	42.00
LSA47A00-2	Wireless quad pet immune motion detector	93.95
LSA57A00-1	Wireless vanishing contact	59.05
LSA58A00-1	Wireless surface mount mini door contact	42.00
LSA50A00-1	Wireless pendant panic alert	36.47
LSA61A00-1	Wireless glassbreak	93.95
IONMICRA-HA	45A00-1 compatible window sensor	24.98
IONPLUNGER-HA	45A00-1 compatible door sensor	24.98



LSA45A00-1



Supervised Wireless Receiver + Interlogix Compatible Transmitters



Compatible Wireless



LSA42A00-2

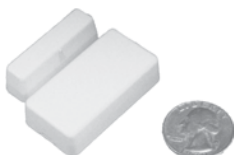

ITI6068895

Note: See page 96 for the cross list between Caddx and ITI part numbers



Wireless vehicle detection is available for both HAI by Leviton and Interlogix wireless receivers.

When using LSA63A00-1 use LSA45A00-1

When using Interlogix wireless (LSA42A00-2) use RESRE104



ITI6087395

ITI6063995R

ITITX4014012

LSA42A00-2	64 transmitter wireless receiver, compatible with GE, Caddx and ITI wireless	272.34
ITI6067095R	White transmitter, 2 AA batteries, built-in reed switch	30.64
ITI60499103195	Slimline crystal transmitter - white - 0.31" x 4.94" x 0.88"	38.29
ITI6068895	Micro crystal transmitter, white - 1.75" x 0.4" x 0.5"	33.70
ITI606881195	Brown micro transmitter, built-in reed switch	33.70
ITITX1510011	Recessed crystal transmitter - 5/8" x 3.5" hole required	37.47
ITI60362N103195	White crystal transmitter, remote contacts 1.57" x 3.16" x 1"	33.70
ITI6064195	White transmitter, longer life version of ITI60362N103195	36.78
ITI60362N113195	Brown transmitter, longer life version of ITI60362N103195	33.70
ITITX1010011	Designline Slim Door/Window - white - 1" x 2.4" x 0.35"	37.47
ITI60606319.5	4-button Crystal keychain remote	35.75
ITI6045710319.5	Double-button Crystal panic sensor, prevents false alarms	34.14
ITI600106495R	2-button SAW keychain remote	24.36
ITITX8010-01-1	Designline tilt-switch garage door sensor, white	37.47
ITITX8300011	Designline tri-zone wireless 3-in-1 sensor, white	46.84
ITI60607319.5	2-button crystal keychain remote	30.64
ITI600106495R	Designline 4-button Keyfob	24.36
ITI605781095	Pendant panic transmitter - Crystal	37.79
ITI6063995R	Wireless PIR motion transmitter, 35' x 40' area	80.79
ITI6080795R	Wireless 40 lb pet immune PIR motion SAW transmitter	74.55
ITI6088095	Wireless PIR Motion Detector, 33-50' range	86.63
ITI6063995ROD	Outdoor PIR Motion Detector, SAW	101.38
ITI6087395	Wireless ShatterPro glass break transmitter, 20' range	73.00
ITI60462103195	Crystal glass guard shock sensor, White	54.07
ITITX6010011	Wireless smoke alarm with sounder	67.46
ITITX6310011	Wireless carbon monoxide gas sensor	88.53
ITI6074495R	Water detection SAW transmitter	45.06
ITI6074295R	Freeze transmitter, 40° F, crystal-White	39.82

Interlogix Compatible Resolution Products Transmitters

RESRE120	Interlogix wireless repeater - can solve supervisory issues	64.95
RESRE104	Vehicle Detector, compatible with GE receivers	94.92
RESRE119	Water and low temp sensor for GE wireless	41.22

Interlogix Compatible iON Security Transmitters

IONMICRA-G	Interlogix compatible concealed wireless window sensor	24.98
IONPLUNGER-G	Interlogix compatible concealed wireless door sensor	24.98
IONFDB75	3/4" Forstner drill bit for drilling perfect holes	6.24
IONWG125	Micra extra-strength magnet for 1.25" gaps	3.12



IONPLUNGER

IONMICRA



Omnistat2 - Hardwired

LSARC1000WH	Thermostat: conventional single stage, heat pump and dual fuel systems	149.62
LSARC1000*	Thermostat: conventional single stage, heat pump and dual fuel systems (*BL-Black, SL-Silver)	149.62
LSARC2000**	Thermostat: conventional 2 stage, 3 stage heat pump, dual fuel systems, humidity and dehumidification	197.49

**-BL-Black, SL-Silver, WH-White

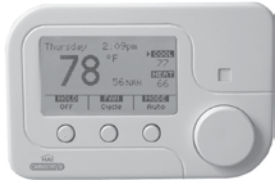

RC1000

- Omni Integration**
- Wires directly to the Omni or Lumina controller
 - Only 3 conductors needed for communication
 - Complete 2-way communication
 - Automated setbacks (choose your approach)
 - Built-in thermostat set point time schedule
 - Automatically change to set points stored in the thermostat based on arming level
 - Use controller logic to control set points
 - Manual override with hold capability



A Large Display Makes Programming Easy

- Easy To Use**
- Simplified and advanced menu structures
 - Automatic changeover between heat & cool
 - Fan cycling for maximum comfort
 - All models meet the EPA's ENERGY STAR guidelines for energy efficiency
 - Outdoor temperature display
 - Time display synced with the controller
 - Select from over 100 different backlight colors
 - Available in Black, Silver, and White

Choosing the Correct Thermostat

	RC2000	RC1000
Humidifier control	•	
Dehumidifier control	•	
Humidity sensing and display	•	
Master thermostat for damper control applications	•	
Supports up to 2-stage conventional & 2-stage heat pump with 3rd-stage auxiliary heat	•	
Supports dual fuel systems	•	•
Automatic heat/cool changeover	•	•
Filter reminder for peak efficiency	•	•
Seven day schedule with copy function	•	•
Fan cycle mode periodically circulates air	•	•
Graphical display of HVAC usage by week	•	•
Eco-friendly design—no batteries to replace	•	•
Indoor sensor averaging with remote sensor	•	•
Motion activated multi-color adjustable backlight	•	•
Temperature readings in Fahrenheit or Celsius	•	•
Learns a home's heating and cooling patterns	•	•
Communicates with Omni systems	•	•
Settings for Home, Night, Away, and Vacation	•	•

Omnistat2 - ZigBee HA

LSARC1000WHZB	ZigBee HA Thermostat: conventional single stage, heat pump and dual fuel systems	208.46
LSARC2000WHZB	ZigBee HA Thermostat: conventional 2 stage, 3 stage heat pump, dual fuel systems, humidity and dehumidification	248.36
LSA81A00-3WHZB	ZigBee HA serial interface	189.47

Omnistat2 Temperature Display Controller



Coming in 2013 is the temperature control and display for the OmniStat2. The single gang interface features an OLED display and simple user controls.



LSA31A00-7

LSA95A03-1	Temperature Display Controller for Omnistats	136.00
------------	--	--------

Omni and Lumina Temperature Sensors

LSA31A00-7	Enhanced Extended Range Indoor/Outdoor Temperature Sensor with mounting bracket	46.32
LSA31A00-8	Enhanced Extended Range Indoor/Outdoor Temperature and Humidity Sensor w/ bracket	89.49
LSA26A00-5	Freeze watch sensor, senses -40° to 120°F, contacts activate at 42°F.	53.34
LSA14A00-8	Water Temperature Sensor module & probe	82.80
LSA1101A	Programmable Energy Saver Module	67.37

CoolMaster - Serial Interface for Split HVAC Systems - Call to Confirm Compatibility

COO1000D	Interface Omni to Daikin VRV Systems	1573.74
COO2000S	Interface Omni to Sanyo VRF Systems	1573.74



COO3000T	Interface Omni to Toshiba VRF Systems	1573.74
COO7000F	Interface Omni to Fujitsu VRF Systems	1573.74
COO9000H	Interface Omni to Hitachi VRF Systems	1573.74
COO4000M	Interface Omni to Mitsubishi Electric VRF Sys.	1573.74
COO8000MH	Interface Omni to Mitsubishi Heavy VRF Sys.	1573.74

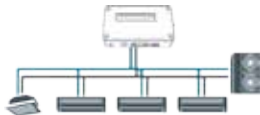

CoolMaster products provide a unified RS232 protocol compatible with Omni and many split HVAC Systems

Thermostat Accessories

LSA29A00-1	Relay Isolation Module: use with first generation Omnistats or Omnistat2's with non-standard voltages	68.77
LSA29A00-2	Relay Isolation Module for use with water furnaces	68.77
LSA30A00-2	Thermostat Power Stealing Boost Module, increases available current to prevent thermostats from resetting	26.63
LSA11A02-1	Replacement 4-pin communication cable for first generation Omnistats and consoles	3.29
LSA65A18-1	Backplate Trim ring for Omnistat2 retrofits	14.91
LSA23A00-1	Surface Indoor Temperature Sensor for thermostats, allows remote mounting of an Omnistat or Omnistat2	36.02
LSA23A00-2	Flush Indoor Temperature Sensor for thermostats, allows remote mounting of an Omnistat or Omnistat2	40.53



LSA23A00-2



LSA23A00-1



Omni-Bus Core Modules (Required on each system)

Module	Description	Price
LSA117A00-1	Omni-Bus Interface Translator - Serial connection to Omni controllers, RF receiver for RF keypads, Ethernet port - DIN Rail Mount	525.61
LSA123A00-1	Omni-Bus Power Supply Module - 24VDC 2.5A - DIN Rail Mount	135.79
LSA124A00-1	Omni-Bus Power Supply Interface - 2A supervision of power to the Omni-Bus network - DIN Rail Mount	104.38
LSA120A00-1	Omni-Bus 8-Way Splitter, connects 8 Cat5 drops to a single Cat5 port - DIN Rail Mount	51.79
LSA122A00-1	Omni-Bus Termination Plug, per system	10.42
LSA121A00-1	Omni-Bus Jumper Plugs, use on any unused Omni-Bus ports - sold in packs of 10	26.53

Omni-Bus Accessories and Accessory Modules

Module	Description	Price
LSA126A00-1	Omni-Bus Scene Control, stores button scene information. Can be used for stand alone installations or with an Omni controller - DIN Rail Mount.	146.42
LSA115A00-1	Omni-Bus RF Transceiver, use for additional RF range when using RF wireless keypads - DIN Rail Mount	102.74
LSA118A00-1	Omni-Bus Digital Addressable Lighting Interface (DALI) Module, includes On/Off switching, dimming, group, broadcast and scene commands - DIN Rail Mount	156.56
LSA116A00-1	USB Programming Interface + software license	259.21
LSA119A00-1	Omni-Bus 3-way splitter	15.63
LSA95A20-1	Single-gang metal switch box	10.61

Need help designing an Omni-Bus system?
Give us a call 800-282-8864

Features:

- The Omni-Bus Lighting Control Network is the hardwired and wireless lighting solution for 220-240V/50Hz applications with a North American version for 110V/60Hz (coming in 2013).
- Omni-Bus products work as stand-alone or with an Omni Home Controller
- An Omni home control system has the ability to change your light settings by the time of day, a set schedule, by the triggering of events (including motion), via a telephone call, touchscreen, Smartphone, or by a computer connected to the Internet.
- Utilizes the DIN rail standard for mounting load control modules
- Supports CFL, LED, electronic low-voltage, Halogen, and incandescent loads
- Dimmer or switch modules feed power to the load
- Keypad buttons are associated with load modules for individual, group control or scene control
- Choose between hardwired or wireless keypads
- Low voltage relay interface (irrigation valves, gates, etc.)

Omni-Bus Input and Output Modules

Module	Description	Price
LSA110A00-2	Omni-Bus Dimming Module, 600W leading edge dimming for incandescent, halogen, electronic or magnetic loads OR, 300W trailing edge dimming for CFL/ LED - DIN Rail Mount	177.60
LSA112A00-1	Omni-Bus Relay Module, 4 relays, 2A each - DIN Rail Mount	104.59
LSA111A00-1	Omni-Bus Switch - 1500W @ 110VAC - DIN Rail Mount	103.95
LSA110A00-1	220V 400W dimmer for international markets	114.63
LSA114A00-1	Omni-Bus 6-Channel Universal Switch Interface, 6 inputs and 6 two-lead bi-color or single-color LED outputs - DIN Rail Mount - Add 114A01-1	51.16
LSA114A01-1	Cable assemblies for 14A00-1 interface: 12 Pack	19.87

Omni-Bus Keypads

Module	Description	Price
LSA113A00-1 LSA113A00-2	Omni-Bus single-button keypad with LED	49.63
LSA113A00-3 LSA113A00-4	Omni-Bus two-button keypad with LEDs	56.84
LSA113A00-5	Omni-Bus three-button keypad with LEDs	61.89
LSA113A00-8	Omni-Bus six-button keypad with LEDs	93.77
LSA113A00-6	Omni-Bus brushed stainless three-button keypad with LEDs	188.44
LSA113A00-9	Omni-Bus brushed stainless six-button keypad with LEDs	236.40

Omni-Bus Wireless Keypads

Module	Description	Price
LSA113A00-2	Omni-Bus Wireless single-button keypad w/ LED	49.26
LSA113A00-4	Omni-Bus Wireless two-button keypad with LEDs	57.14
LSA113A00-7	Omni-Bus Wireless three-button keypad w/ LEDs	66.95
LSA125A00-1	Omni-Bus Wireless 6-channel keyfob remote	36.47
LSA125A00-2	Omni-Bus Wireless 16-channel keyfob remote	41.05

Key Features of Home Lighting Control

- Home Lighting Control (HLC) uses proven UPB technology with over a 9-year track record for reliability and ease of installation
- “Programming on the 8’s” technology makes it easy to list rooms and devices on touchscreens and mobile interfaces. No additional programming required.
- Complete 2-way scene-based lighting system with room controllers, whole house status monitoring and individual load control
- 3-phase repeater is available for small commercial or residential MDU applications
- Gen III dimmers provide automatic timeout, ability to switch dim/non-dim in the field, better CFL/LED compatibility, and better tolerance for power frequency variations



Home Lighting Control on a Touchscreen



Home Lighting Control on an iPhone

Lighting Control Keypads (Requires Neutral)**

LSA38A00-1	6-button UPB Room controller with IR (scene switch), white	114.74
LSA38A14-1	IR Handheld remote control for the 6-button room controller - Free on request with purchase of an LSA38A00-1 (while supplies last)	41.09
LSA38A00-2	8-button UPB House controller (house status switch), white	136.28
LSA38A16-*	Tabletop cradle with UPB Room controller (WH-White, BL-Black)	156.32
LSA38A15-*	Tabletop cradle for UPB Room controller	*Black 30.32 *White 30.32

** Case Quantity Discount is Already Applied to Individual Unit Sales



LSA38A00-1 LSA38A00-1 in a LSA38A15 Tabletop Base LSA38A00-2

Custom Engraving

LSA38A06-2	Custom engraving coupon for HLC controllers	FREE*
------------	---	-------

* For engraving details: www.homeauto.com/HowtoBuy/Promotions/Engraving.asp

Learn more about HLC at: www.worthingtonu.com

Lighting Control Dimmers and Switches (Requires Neutral)*



LSA71A00-1



LSA35A00-1

LSA35A00-1	600W inductive UPB dimmer with tri-colored LEDs	63.07
LSA35A00-3	600W inductive UPB non-dim switch with tri-colored LEDs	63.07
LSA40A00-1	15A UPB relay switch with tri-colored LEDs	80.24
LSA35A00-1CFL	600W Compact Fluorescent dimmer with tri-colored LEDs	62.86
LSA71A00-1	HLC 30A 120/240 load control module	181.79
LSA37A00-1	Auxiliary switch for 35A00-1, 40A00-1, and 55A00-1 3-way applications	26.22

* Case Quantity Discount is Already Applied to Individual Unit Sales.

Lighting Control High Wattage Dimmers (Requires Neutral)



LSA39A00-3



LSA39A00-2

LSA55A00-1*	1000W inductive UPB dimmer w/ tri-colored LED, fits in single gang box *WH-White, IV-Ivory (AL-Almond, BL-Black, BR-Brown while supplies last)	135.58
LSA55A00-3*	2400W inductive UPB dimmer with tri-colored LEDs. (*WH-White, IV-Ivory)	335.36



LSA38A14-1



LSA55A00-1

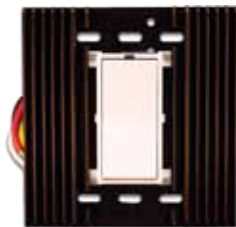

LSA55A00-3



LSA60A00-1

Lighting Control Plug-In Devices

LSA59A00-1	300W UPB Lamp Module	63.66
LSA60A00-1	15A Appliance Module	80.32

2400 Watt Dimmer Wallplates

LSA55A03-*	2400W (1-White, 2-Ivory)	12.57
------------	--------------------------	-------

Lighting Color Change Kits

LSA35A14-*	Change kit for 35A00 Dimmer, 40A00 Switch, 37A00 Auxiliary	4.09
LSA38A04-*	6-button Room controller	3.23
LSA38A05-*	8-button House controller	3.23

*WH-White, IV-Ivory, AL-Almond, BL-Black, BR-Brown, GR-Gray, or LTA-Lt. Almond

Home Lighting Control UPB Accessories

LSA36A00-1	UPB Powerline Interface Module with cable for Omni family of controllers	65.98
LSA36A05-2	Cable for serial PC to LSA36A00-1 (PIM) connection for UpStart software	9.68
LSA39A00-1	UPB Phase Coupler (different than X10 coupler) with LED indicator	61.84
LSA39A00-3	3-Phase UPB Repeater	419.93
LSA39A00-2	Split Single Phase UPB Repeater	293.45



ZigBee HA Interface Module

LSA81A00-3WHZB	Serial ZigBee RF MicroControl coordinator.	189.47
Use with Omni and Lumina controllers.		

ZigBee HA Load Control Modules

LSA73A00-3ZB	30 AMP ZigBee HA RF control module	189.47
LSA73A00-4ZB	5A AMP ZigBee HA RF control module	182.45
LSA89A00-1ZB	15 AMP Plug-in ZigBee HA RF module	126.21

ZigBee HA Thermostats

LSARC1000*ZB	Thermostat with ZigBee RF Transceiver: conventional single stage, heat pump and dual fuel systems	208.46
LSARC2000*ZB	Thermostat with ZigBee RF Transceiver: conventional 2 stage, 3 stage heat pump, dual fuel systems, humidity and dehumidification	248.36
*-BL-Black, SL-Silver, WH-White		

ZigBee HA Micro Controller

LSA81A00-2WHZB	Serial ZigBee RF MicroControl coordinator	198.63
LSA81A00-4WHZB	Remote screen for the MicroControl	189.47



Azela Features:

- ZigBee HA communication protocol
- Button for system capture and manual operation
- LED with feedback for load status and configuration

CL3385001-HA*	Azela One-Button Dimmer, 800W	69.94
CL3385001-RHA*	Azela One-Button ON/OFF Relay, 1000W	69.94

*=W-White, I-Ivory, LA-Light Almond, B-Black, wallplates sold separately

Kwikset ZigBee HA Access Control Deadbolt and Lever Sets



BD99100-017	1	ZigBee HA Standard Motorized Deadbolt - Venetian Bronze	209.95
BD99100-016	2	ZigBee HA Standard Motorized Deadbolt - Satin Nickel	209.95
BD99100-015	3	ZigBee HA Standard Motorized Deadbolt - Polished Brass	209.95
BD99100-019	4	ZigBee HA Contemporary Motorized Deadbolt - Satin Chrome	209.95
BD99100-018	5	ZigBee HA Contemporary Motorized Deadbolt - Satin Nickel	209.95
BD99100-020	6	ZigBee HA Contemporary Motorized Deadbolt - Polished Chrome	209.95
BD99100-021	7	ZigBee HA Contemporary Motorized Deadbolt - Venetian Bronze	209.95
BD99120-007	8	ZigBee HA Motorized Lever Lock - Polished Brass	209.95
BD99120-008	9	ZigBee HA Motorized Lever Lock - Satin Nickel	209.95
BD99120-009	0	ZigBee HA Motorized Lever Lock - Venetian Bronze	209.95

ZigBee HA Integration



- ZigBee HA Profile is a standardized protocol for ZigBee radios which allows integration between products
- The ZigBee Interface Module is designed to work with ZigBee HA Profile products
- Products on this page feature ZigBee HA communication
- ZigBee HA Profile products work together to form a communication mesh

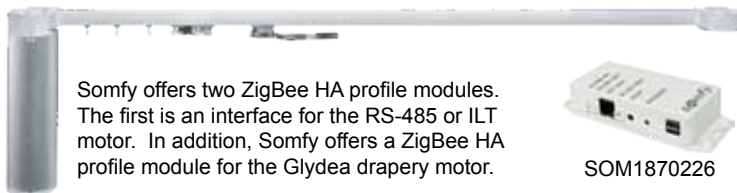

Somfy offers two ZigBee HA profile modules. The first is an interface for the RS-485 or ILT motor. In addition, Somfy offers a ZigBee HA profile module for the Glydea drapery motor.

SOM1870226

SOM1870221	Add ZigBee HA Profile to a Glydea drape motor	166.66
SOM1870220	Add ZigBee HA Profile to an RS-485 or ILT motor	199.84

ZigBee HA Lock Integration



- Lock compatibility: OmniPro II, Omni Ile, Lumina Pro, or Lumina with firmware 3.10 or later
- The ZigBee Interface Module (ZIM) needs to be running firmware 14.16 or later
- The controller can lock and unlock the locks and monitor changes in the status of the locks
- Lock status and state changes can be used in programs



YALD220ZBHA+	Motorized ZigBee HA Deadbolt with capacitive touch keypad	206.08
YALD240ZBHA+	Keyless Motorized ZigBee HA Deadbolt with capacitive touch keypad. No lock cylinder.	206.08
YALD210ZBHA+	Motorized ZigBee HA Deadbolt with pinpad	168.62
YALL220ZBHA+	Motorized ZigBee HA Entry Lever Set with capacitive touch keypad	187.35
YALL210ZBHA+	Motorized ZigBee HA Entry Lever Set with pinpad	187.35
(+605-Bright Brass, 0BP-Oil Rubbed Bronze, or 619-Satin Nickel)		





Lock Integration



- Use a Leviton VRC0P '3' series Z-Wave serial interface for each installation
- Each installer will need a Leviton VRUSB-1US USB stick to enroll the lock on the Z-Wave network
- Download the Vizia RF + Installer Software: www.leviton.com/rfinstaller
- 'Beaming Compatible' Z-Wave devices are required for extending communication to Z-Wave Locks

LEVVRUSB-1US	USB adapter for RF+ Installer software	69.92
LEVVRC0P-1LW	Vizia RF + Z-Wave serial interface module	89.15

Purchase \$500 of Vizia RF + and receive a FREE VRC0P serial module



ONLY Leviton Vizia RF + Z-Wave products are 2-way with Omni controllers (unless the Omni is programmed to poll for status updates). See pages 12 - 13 for Leviton Vizia RF + products and information on beaming compatibility.

- The 2-way capability of Vizia RF + becomes important when using interfaces such as Snap-Link Mobile or touchscreens
- Other Z-wave devices may have beaming support; however, if the state is changed manually the Omni is not notified.
- Beaming capability in Z-Wave devices is required to enable the automation controller to wake and communicate with locks

Z-Wave Locks Compatible with Omni Controllers

	BALDWIN	
Boulder Deadbolt		SOHO Deadbolt
BD8252xxxAC3	Boulder Deadbolt: xxx = 003-Lifetime Polished Brass, 402-Distressed Oil Rubbed Bronze	371.58
BD8285056AC3	SOHO Deadbolt: Lifetime Satin Nickel	371.58
BD8252xxxAC3	Boulder Deadbolt: xxx = 102-Oil Rubbed Bronze, 112-Venetian Bronze,	352.84
BD8285xxxAC3	SOHO Deadbolt: 150-Satin Nickel, 260-Polished Chrome, 264-Satin Chrome	352.84

	Kwikset	
Standard		Entry Set
BD99100-00*	Standard Motorized Deadbolt: * = 4-Polished Brass, 5-Satin Nickel, 6-Venetian Bronze	168.62
BD99100-01*	Contemporary Motorized Deadbolt: * = 1-Satin Nickel, 2-Satin Chrome, 3-Polished Chrome, 4-Venetian Bronze	168.62
BD99120-00*	Motorized Lever Lock: * = 4-Polished Brass, 5-Satin Nickel, 6-Venetian Bronze	168.62

	Yale		
Pinpad		Touch	Keyless
YALD220ZW+	Motorized Z-Wave Deadbolt with capacitive touch keypad	206.08	
YALD240ZW+	Keyless Motorized Z-Wave Deadbolt with capacitive touch keypad. No lock cylinder	206.08	
YALD210ZW+	Motorized Z-Wave Deadbolt with pinpad	168.62	
YALL220ZW+	Motorized Z-Wave Entry Lever Set with capacitive touch keypad	206.08	
YALL210ZW+	Motorized Z-Wave Entry Lever Set with pinpad	187.35	

(+605-Bright Brass, 0BP-Oil Rubbed Bronze, or 619-Satin Nickel)

	SCHLAGE	
Camelot		Entry Lever Set
SCHBE469CAM*	Camelot Z-Wave Motorized Touchscreen Deadbolt: *505-Bright Brass, 619-Satin Nickel, 716-Aged Bronze	174.96
SCHBE469CEN*	Century Z-Wave Motorized Touchscreen Deadbolt: *619-Satin Nickel, 625-Bright Chrome, 626- Satin Chrome	174.95
SCHFE599*	Z-Wave Entry Lever Set with electronic clutch: *505-Bright Brass, 619-Satin Nickel, 716-Aged Bronze	164.81

Access Control / 5.7 Touchscreen Power Supplies

LSA83A00-1	12VDC 5A power supply in an enclosure	230.18
LSA83A00-2	12VDC 5A power supply on mounting plate	230.18
UB1250	Battery, rechargeable, 12V, 5 Ah	11.01

LSA83A00-1



- Output: up to 5 amps @ 12VDC
- Connect up to 2 12VDC 8Ah batteries for backup
- Can power up to 8 readers with door strikes
- Can power up to 8 consoles or 5.7 touchscreens
- Can power up to 4 readers with door strikes and (4) 5.7 touchscreens
- 110VAC powerpack included

LSA54A00-1	Outdoor Brushed Stainless Serial Keypad	288.32
------------	---	--------

LSA54A00-1



- Brushed stainless design for outdoor applications
- Piezoelectric buttons can be used with a bare finger or gloves
- Connects to an Omni controller via the serial port
- More than 1 keypad can be connected on a single serial port
- Vandal resistant

Access Control Reader and Door Strike

- 26-bit proximity card reader
- Connects to an Omni controller serial port
- Durable and scratch-resistant polycarbonate housing
- Full epoxy potting ensures full-weather resistance
- 2 color LEDs and piezo sounder ensures an intuitive interface
- Doorstrikes can be connected directly to the reader
- Seamless integration in 3.0 firmware and software



LSA75A00-2



LSA78A00-2



LSA79A00-1



LSA78A00-1

LSA75A00-2	Access Control Card Reader: Requires 3.0+ firmware and power supply	196.49
LSA78A00-1	Pack of 10 Access Control cards	40.53
LSA78A00-2	Pack of 10 key tags	53.26
LSA79A00-1	Fail secure 12VDC door strike	51.28
SENRCCR-REX-W	Dual tech request-to-exit motion, form C	63.77

NEC Phone System Integration

Control an Omni from an NEC Phone System



What better place to control your automation system than from the display phone sitting on your desk? Now, in addition to the great analog and IP features found in a DSX phone system, you have full 2-way control from any display phone. Each DSS key can be programmed to access a different section of automation including lighting, security, audio, temperature, buttons, etc. In addition, the LED for the DSS can be used to track status! Looking to mute an audio zone when an extension goes off hook or is paged? Look no further than the NEC DSX phone system; the integration is amazing.

Learn more about NEC Phone Systems on page 153



Control of Hi-Fi 2 without a Controller



Leviton Security & Automation apps do not always need a controller. The apps for iPhone, iPod touch and iPad allow a user to control a Hi-Fi 2, and iDock directly over Wi-Fi and IP. Configuration is easy, just type in the IP addresses and the app does the rest.

BlueTooth Remote Input Module (RIM)



The new Bluetooth Remote Input Module (RIM) allows Bluetooth-enabled devices to connect and act as music servers for the Hi-Fi 2 distributed audio system. Play music from Pandora, Spotify, Rhapsody, iTunes, or any other service compatible with Bluetooth enabled portable audio devices.

Available only in white.



iPod Dock



The iPod Dock is compatible with iPod, iPod Touch, and iPhone. Allows users to access music and content (including meta-data) that is on an iPod through IP enabled devices, such as OmniTouch 7 touchscreens, the iPhone/iPad/Android apps and Hi-Fi 2 audio distribution systems. The communication connection can be over a wired 10/100 LAN network or a Wi-Fi connect. The audio connection must be wired. The dock charges the iPod battery when docked and has a 3.5mm audio output jack to connect audio as a source into a distribution system. The US version is for use in North America.

LSA96A00-1	iPod Dock - Wired (US)	314.66
LSA96A00-2	iPod Dock - Wireless (US)	399.04
LSA96A01-1	Replacement power supply for the iPod Dock	27.79

EU versions available, please call or e-mail for pricing

LSA95A04-2	Bluetooth Remote Input Module (RIM) for Hi-Fi 2	188.40
LSA95A15-*	Color change for the Bluetooth RIM	6.13

*WH-White, IV-Ivory, AL-Almond, BL-Black, LTA-Lt. Almond

Leviton Spec-Grade Speakers

LEVSGC65-W	6.5" In-ceiling 120W Kevlar woofer-pair	58.70
LEVSGI65-W	6.5" In-wall 120W Kevlar woofer-pair	69.78
LEVSGI80-W	8" In-wall 160W Kevlar woofer-pair	107.23
LEVSGO99-W	5.25- Inch Two-Way Outdoor/Utility-each	98.57



LEVSGO99-W

LEVSGC65-W

LEVSGI65-W/
LEVSGI80-W

2-Way Voice Integration with Hi-Fi 2 Page Input

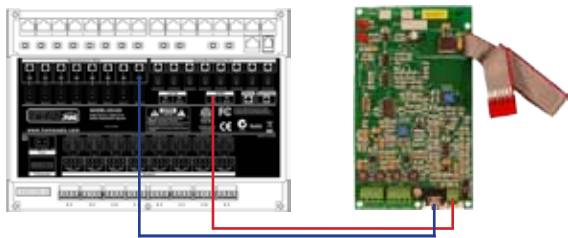

Looking to have the Omni speak throughout the house or looking to use any phone in the house as an "All Page?" It is simple. Just add an LSA10A11 two-way voice board and connect it to the Hi-Fi 2. Start with an 1/8" mono jack and attach the two leads to the trigger output of the LSA10A11 board. If you need a cable, an IR emitter works great, just cut off the flasher. Next, use a stereo 1/8" connection between the audio out on the LSA10A11 and input 8 on the Hi-Fi 2 (mono does not work). Use the Hi-Fi 2 software to set up page zones and volume. Any time the LSA10A11 is active (LED is on) the page feature will activate.

LSA10A11	2-way Voice Board - Features a line level output and relay. Includes a 12VDC trigger for speech over a Russound CAV6.6, MCA-C5, or Hi-Fi 2.	98.50
----------	---	-------

Russound Acclaim Thin Bezel Speakers

RSRSF-61	6.5" Polypropylene woofer, 3/4" pivoting PEI tweeter, 5 - 80 watts, pair	50.00
RSRSF-61T	Single point stereo: 6.5" IMPP Ribbed woofer, two 3/4" pivoting PEI tweeters, 5 - 120 watts, each	50.00
RSRSF-62	6.5" Polypropylene woofer, 1" pivoting Silk tweeter, 5 - 90 watts, pair	100.00
RSRSF-63	6.5" IMPP Ribbed woofer, 1" pivoting Silk tweeter, 5 - 100 watts, pair	150.00
RSRSF-64	6.5" Kevlar woofer, 1" pivoting Teteron tweeter, 5 - 120 watts, pair	200.00
RSRSG-S	Square Speaker Grilles for in-wall installations	12.51

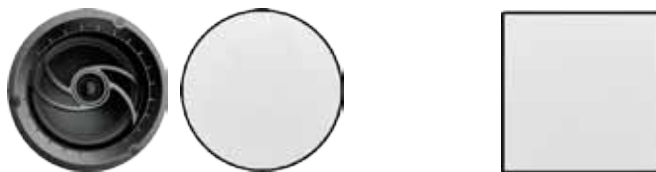

Change from a ceiling speaker to a wall speaker by changing the grill

Say goodbye to crooked in-wall installations, simply rotate the grill until it is level!

Hi-Fi 2 Distributed Audio

Hi-Fi 2 Systems

LSA95A00-1	8-Source, 8-Zone Kit in enclosure, 4 RIMs (4 sources can be plugged in directly), 8 VSCs, IR Remote	1998.46
LSA95A00-2	8-Source, 8-Zone Kit for structured wiring, 4 RIMs (4 sources can be plugged in directly), 8 VSCs, IR Remote	1998.46
LSA95A01-1	8-Source, 8-Zone Amplifier Only	1472.83

Hi-Fi 2 Expansion Systems Zones 9-16

LSA95A12-1	8-Source, 8-Zone Expansion Kit in enclosure, 8 VSCs. Must be mounted within 6" of the main Hi-Fi 2 system, interconnect cable.	1893.39
LSA95A12-2	8-Source, 8-Zone Expansion Kit for structured wiring, 8 VSCs. Must be mounted within 6" of the main Hi-Fi 2 system, interconnect cable.	1893.39
LSA95A18-1	8-Source, 8-Zone Expansion Amplifier only, expansion cable	1420.08

Hi-Fi 2 Volume and Source Selection (VSC) Keypad

LSA95A03-1	Hi-Fi 2 Keypad with OLED display and IR receiver	136.00
LSA95A11-*	Hi-Fi 2 Keypad (VSC) color change kit	2.74

*WH-White,IV-Ivory,AL-Almond,BL-Black,LTA-Lt. Almond



Hi-Fi 2 Features

- 8-Source / 8-Zone with 50 Watts per zone digital amplification
- Expandable to 8-Source / 16-Zone with the LSA95A12
- Keypads feature a crisp OLED display
- Simple 4-Button interface for power, volume, source selection and audio settings
- Input 8 can be used as a system page
- Built-in serial or Ethernet communication
- Built-in power supply
- Compatible with OmniPro II, Omni Ile, Omni LTe, Lumina Pro and Lumina controllers
- Compatible with OmniTouch 7 touchscreens as well as OmniTouch Pro software



Flexible Source Wiring

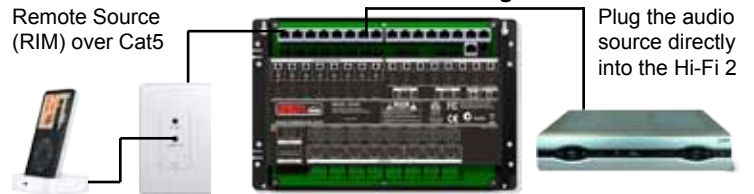

Hi-Fi 2 Remote Input Module (RIM)

Hi-Fi 2 allows the installer to locate Remote Input Modules (RIMs) near sources to make audio available in each room with a Volume Source Control (VSC) and speakers. The amplifiers mount on a closet wall or in a structured wiring cabinet for a clean installation. Hi-Fi supports up to eight zones and six sources. It fully integrates with Omni controllers, touchscreens, and software packages.

LSA95A03-1	Hi-Fi 2 Remote Input Module (RIM)	136.00
LSA95A10-*	Hi-Fi 2 Remote Input Module color change kit	2.74

*WH-White,IV-Ivory,AL-Almond,BL-Black,LTA - Lt. Almond

See page 66 for the Bluetooth Remote Input Module (RIM)

Hi-Fi 2 Accessories

LSA95A09-1	Hi-Fi 2 vented enclosure	86.06
LSA95A05-1	IR remote control for the Hi-Fi 2	25.00
LSA95A16-1	Hi-Fi 2 expansion cable	15.79

Hi-Fi 2 Source Cables

LSA95A14-1	Retractable male 3.5mm to male 3.5mm cable, for use with Hi-Fi 2 RIM	7.96
LSA95A13-1	Retractable male 3.5mm to male RCA cable, for use with Hi-Fi 2 RIM	7.96

Hi-Fi 2 4x4 Distributed Audio

New For 2013



LSA95A00-3*	Hi-Fi 2 4x4 System: Includes the Hi-Fi 4x4, 2 Remote Input Modules (RIM), 4 OLED Volume-Source Controls (VSC), remote control & power supply; Mount directly into a Leviton Structured Media Center wiring enclosure.	999.14
-------------	---	--------

* UK (95A00-4), EU (95A00-5) and AU (95A00-6) versions are available

Hi-Fi 2 4x4 Features

- 4-Source / 4-Zone with 40 Watts per zone digital amplification
- Keypads feature a crisp OLED display
- Simple 4-Button interface for power, volume, source selection and audio settings
- Built-in serial or Ethernet communication
- Compatible with OmniPro II, Omni Ile, Omni LTe, Lumina Pro and Lumina controllers
- Compatible with OmniTouch 7 touchscreens as well as OmniTouch Pro software



Demonstration Kits



OmniPro II LSA18A00-13 Demo System

- OmniPro II
- 5.7 Touchscreen*
- HLC house and room controller
- HLC Dimmer
- Thermostat
- Console with 2-way voice module

* At press time the demokit had not changed from the 5.7 touchscreen. Please call for the latest information on demokit configuration and pricing.

LSA18A00-13	OmniPro II Demo System with touchscreen, UPB house controller, room controller, dimmer, thermostat, console, and voice module in case	2947.26
LSA18A00-5	Omni Ile / OmniPro II Demo Adapter Kit. Provides telephone talk battery and pushbuttons for simulation.	60.00
LSA18A00-16**	OmniPro II Demo System with touchscreen, card reader and electric door strike in a case ** - No letter code required for English, SPA = Latin Spanish, FR = French, IT = Italian, SPE = European Spanish, CAT = Catalan	3500.00
LSA18A00-14	Lumina Demo System with touchscreen, UPB house controller, room controller, dimmer, UPB PIM, thermostat, and console, in travel case	3087.68
LSA18A00-20	MicroControl Energy Management Demo Case with ZigBee MicroController, thermostat and plug in module	1121.40
LSA18A00-15	Hi-Fi 2 One Zone Demo Case with IR remote	2103.85

Controller Mounting Plates



LSA20A07-2

LSA20A07-2	Structured Wiring Plate for Omni Pro II, Ile, LTe Lumina Pro, Lumina, and OA171 Expander, fits Leviton, Open House, Legrand, and UStec enclosures	26.00
------------	---	-------

Controller Accessories

LSA100925	Replacement terminal strips for Omni Ile, Omni LTe, OmniPro II, Lumina, & Lumina Pro - need 4, priced each	5.26
LSA11A02-1	4-pin omnistat and console replacement cable	3.29
LSA10A08-1	Replacement 20-pin communicating ribbon cable, used to connect expansion modules to each other and the main board	5.26
LSA21A06	Omni enclosure lock and key	9.30
LSA101905	Bag of 10 stand-offs for add-on boards	3.95
LSA103480	16 piece pack of 1000 Ohm resistors	1.32

Advance Lighting Control (ALC)

LSA25A00-1	1-branch ALC Interface	156.55
LSA25A00-2	4-branch ALC Interface	314.21

ALC devices are available on request. Please call for details.

Firmware Chip Upgrades

LSA20A04-2	OmniPro II Chip Upgrade	53.19
LSA20A04-50	Omni Ile Chip Upgrade	53.19
LSA20A04-1	Omni II Chip Upgrade	53.19
LSA20A04-21	Lumina Chip Upgrade	53.19
LSA20A04-22	LuminaPro Chip Upgrade	53.19



Not needed with a new controller.

Modern Omni controllers use flash RAM and no longer need chips.

Whole House Voice Annunciation with Russound

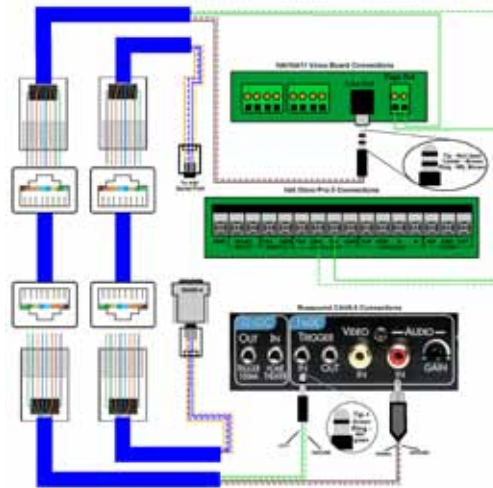

Overview: An LSA10A11 2-way Voice Board (Revision B) can be used with an MCA-C5 or MCA-C3 distributed audio system. This allows annunciation of messages from the Omni to all zones in the whole house audio system. It also allows whole house paging from the telephone.

Note: Separating data and the analog audio is strongly recommended.

Configuration: The 2-way voice board can generate a contact closure and line level audio when active. The wiring diagram shows the Auxiliary 12VDC routed through the relay providing 12VDC when the voice board is active. The 12VDC activates the page input on the Russound allowing Omni speech and telephone paging phone to be distributed throughout the home.

Relay Modules

LSA10A07	4-Relay Module with mounting tape	48.63
LSA19A00	8-Relay Module with mounting tape	78.77
LSA19A00-1H	8-Relay module with controller mounting kit	83.03



Omni controllers and expanders use 12VDC triggers. For dry contact closure, add a relay board.

RS-485 Serial Keypad Scene Switch



- Custom label buttons with any printer
- Launch Omni programs based on button presses and instruct the LEDs to turn on, off, or blink directly from the LSA controller ("WHEN SCENE SWITCH" in 2.16 or later)
- LSA supports up to 16 keypads on an RS-485 loop

RCSKPL7AS-W

RCSKPL7AS-W	7-button LED keypad, use Omni controllers (2.16 firmware or later)	102.11
-------------	--	--------

Installation

PRBTM5D4-W	1x4 - 110 block - on-wall mount enclosure	13.88
------------	---	-------



PRBTM5D4-W

When installing an Omni with multiple keypads or thermostats, multiple cables can land on the same screws. This 110 punchdown allows for a single run from the panel and individual drops to each device.

Miscellaneous Power Options

ALTAL624	1.2A @ 12VDC & 0.75A @ 24VDC, requires 24VAC transformer feed, see below, board only	10.39
ALTAL624E	1.2A @ 12VDC & 0.75A @ 24VDC in enclosure, requires 24VAC transformer feed, see below	31.85
ALTAL300ULB	2.5A @ 12/24VDC supervised AC and battery monitoring, limited output, board only	67.76
ALTAL300ULXR	UL fire listed 2.5A @ 12VDC or 24VDC in enclosure, supervised power supply/charger, 115VAC input	136.45
LSA83A00-1	12VDC 5A power supply in an enclosure	230.18
LSA83A00-2	12VDC 5A power supply for structured wiring	230.18
ELKTRG2440	Transformer, 24VAC, 40VA, auto-resetting, grounded, use with LSA Controllers & OA171	14.14
ELK1280	Battery, rechargeable, 12V, 8 Ahr	26.49
ELK1250	Battery, rechargeable, 12V, 5 Ahr	18.60

LSA83A00-1



- Output: up to 5 amps @ 12VDC
- Connect up to 2 12VDC 8Ah batteries for backup
- Can power up to 8 readers with door strikes
- Can power up to 8 consoles or 5.7 touchscreens
- Can power up to 4 readers with door strikes and (4) 5.7 touchscreens
- 110VAC powerpack included

KNX Lighting Interface



The KNX Gateway allows Omni and Lumina controllers (Omni IIe, OmniPro II, Lumina, and Lumina Pro) to communicate with and control KNX devices installed on the network. Lighting, temperature and energy management, and motors (window coverings, shades, shutters, etc.) are among the many KNX devices that can be controlled from an Omni interface or via controller programming.

LSA97A00-1	KNX Communication Gateway	841.02
------------	---------------------------	--------

Lighting Load Control Modules



LSA72A00-1



LSA71A00-1

LSA72A00-1	12VDC input 20A load control module	56.89
LSA71A00-1	HLC 30A 120/240 load control module	181.79

Control 30 AMP Loads with an Omni Output



CHC25DND230T

- 1 - CHC25DND230T 30 amp contactor
- 1 - HWHCENC enclosure
- 1 - LSA10A07 relay board

Wire the load to the contactor. Use an Omnirelay to switch 24VAC feeding the contactor coil. Always follow NEC.

HWDP2030A5004	30a 110VAC - 2 Pole 24VAC Contactor	17.34
HWHCENC	6x6x4 Metal Enclosure for HWDP2030A5004	8.66

Cellular Backup



The LSA70A00-2 Now Supports Caller ID

The C3 (Cellular Communications Center) wireless cellular communicator allows phone calls to be made over the GSM cellular network using the existing telephones in your home. The C3 can be used when there is no land line in your home or if the land line is temporarily unavailable.

The C3 is perfect for homeowners without land lines, vacation homes, and locations that need remote monitoring. It works with any standard security panel, including the Omni family of home controllers, to communicate alarm conditions using the GSM cellular network when the land line or cable phone service has been cut.



Use cell as a primary phone line



Use cell as a security backup

LSA70A00-2	GSM Universal Cellular Backup, simulates dial tone and works on ANY control panel. Requires GSM SIM card and service. Provides a phoneline anywhere there is cell service. Relays all DTMF monitoring.	210.53
------------	--	--------

2-Way Voice

LSA10A11	2-way Voice Board: Features a line level output and relay. Includes a 12VDC trigger for speech over a Russound CAV6.6, MCA-C5, or Hi-Fi 2.	98.50
LSA28A00-1	Speaker and microphone for LSA10A11, surface-mount enclosure, maximum 2 per installation	25.00
LSA28A00-2	Speaker and microphone for LSA10A11, flush-mount enclosure, maximum 2 per installation	21.05

Serial Boards and Cables

LSA10A17-1	RS-232/485 Serial Board, max 1 per system	175.44
LSA21A05-2	7' RJ11 line cord with modular RJ11 to DB9 adapter (programming cable)	13.97
LSA36A05-4	RJ-11 to DB-9M straight through serial. Use with Russound, Lutron, RadioRA 2, Jandy & Centralite	9.47
LSA36A05-2	Serial PC to LSA UPB PIM (UpStart)	9.68
BL180503	DB9F to DB9F 6' null cable for 10A17-1 Serial	1.26
HVCABLE	DB9F to DB9M 6' straight cable for 10A17-1 Serial	5.00
ELKUSB232	USB to RS-232 interface. Requires LSA21A05-2	34.21



LSA10A17-1



BL180503 HVCABLE LSA36A05-4 LSA21A05-2
LSA21A05-2 - Programming cable
LSA36A05-4 - Connectivity cable
LSA36A05-2 - UPB PIM to a PC

Omni Software Comparison



1120 Snap-Link PC

Snap-Link
iOS/Android

1105W PC Access



Customized iRule Control

	Snap-Link PC	Snap-Link iOS/Android	PC Access	Automation Studio	OmniTouch Pro	iRule Pro Builder with Automation Module
Part Numbers	1120	Purchased in the App store	1105W, 1106W, 1111, 1105WSP	1126	1131	IRUPROBUILD IRUAUTOMATE
Access via Internet	Yes	Yes	Yes	No	Yes	Yes
Monitor/Control System	Yes (graphical)	Yes (graphical)	Yes (tree based)	Yes (graphical)	Yes (graphical)	Yes (graphical)
Dedicated Computer On-Site	No	No	No	No	No	No
Subscription Fee	No	No	No	No	No	No
Video Surveillance	Link to installed IP Web Camera	LSA cameras EverFocus DVR	No	Yes	Yes	Yes
Video Recording	No	No	No	No	No	No
Notifications	Email, messaging, pop-up notifications, visual	No	No	Email, messaging, pop-up notifications, visual	Email, messaging, and visual	No
User Interface	PC application	Application	PC application	5.7e and touchscreens	PC application	Fully customizable
Additional Interfaces Supported	Ultra Mobile PC (full Windows operating system)	iOS - HTX2	None	5.7e and touchscreens running OmniTouch Pro software	3rd Party Touchscreens	Create interfaces for iOS or Android
Program System	No	No	Yes	No	No	No
Create Rules	Yes	No	No	No	No	No
Selectable Skins or Themes	Yes	No	No	Fully customized	Fully customized	Fully customizable
RSS (Real Simple Syndication)	No	No	No	No (future option)	No (future option)	No
Installation Components	No installation (Plug and Go)	No installation (Plug and Go)	Application	Application	Application	Web Based
Operating Systems	Windows ME and higher	iOS Android	Windows® 98SE & higher, Vista Ultimate, Vista Home Premium, Windows 7	Windows XP, Vista, or Windows 7	Windows XP, Vista, or Windows 7	iOS Android

LSA1105W	Dealer Software for Windows® for the Omni family of controllers, free updates for registered users	138.16
LSA1106W	End User Software for Windows®, same as dealer software, without dealer sections, free updates for registered users	51.20
LSA1111	Dealer Software for Windows® for the Lumina family of controllers, free updates for registered users	47.37
LSA1120	Snap-Link provides remote access for OmniPro II, IIe, Lumina and Lumina Pro. Includes a skin for PC touchscreens and free updates for registered users	51.58
LSA1126	Automation Studio configuration software for custom interfaces on a PC running OmniTouch Pro	209.47
LSA1131	OmniTouch Pro Software - software which allows Automation Studio to work with third party touchscreens - XP, Vista, Win 7	62.11
IRUPROBUILD	Provide home theater control on iPad, iPhone, iTouch or Android interfaces for up to 5 devices*	90.00
IRUAUTOMATE	Add Omni control for lighting, HVAC, lock control and security to an iRule interface*	25.00

* Contact Worthington Distribution to create an iRule Dealer Account. More information on iRule is available on page 47



iRule

New For 2013

See page 47 for the complete iRule listing

- Create customized interfaces for Home Theater, Lighting, Thermostats, Access Control (Locks), and Security
- Graphics libraries are included and are shared between iRule users
- iRule is compatible with iOS and Android mobile devices
- Simply drag and drop the Omni control icon into the iRule Builder and assign the unit number, thermostat number or lock number, the rest is automatic
- Mix home theater and Omni control in a common interface for the ultimate end user experience

PC Access (1105W, 1105WSP, 1106W, 1111)

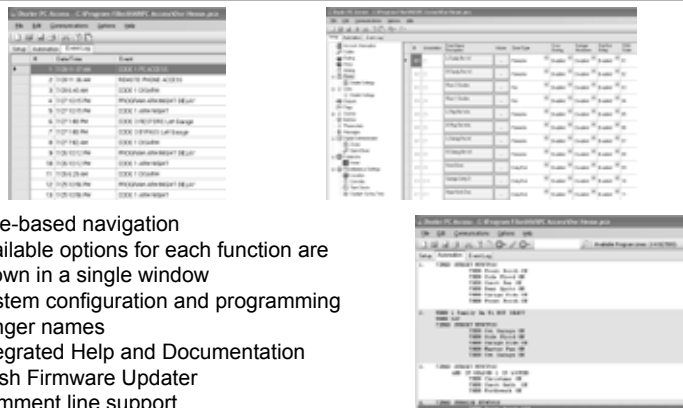

- Tree-based navigation
- Available options for each function are shown in a single window
- System configuration and programming
- Longer names
- Integrated Help and Documentation
- Flash Firmware Updater
- Comment line support



- iRule is a cloud service. All interfaces are built in a web browser.
- Edit customer's projects from anywhere in the world
- A Dealer Portal allows you to manage all customer's projects and accounting in one easy to use interface
- A project wizard allows dealers to get projects up and running in minutes
- Projects can be highly customized providing customers with interfaces that match their tastes and personality



Lighting



Security



Temperature

- Add the Automation module to any project to control lighting, thermostats, security and locks in seconds.
- No scripting or programming necessary

Automation Studio (1126) with OmniTouch Pro (1131)



- Compatible with the OmniTouch Pro
- Customize the Omni template to provide a high-end interface quickly and easily
- No coding required
- Use predefined functions to create buttons, show system status, custom list boxes or any other object found in the screen template

- Create icons which track status and place them on a blueprint of the home
- Provide custom backgrounds showing family pictures or build a complete theme using the customer's favorite sports team. The options are limitless.
- Provide home theater control by adding a Home Theater Extender
- Add enhancements to the system such as sending emails or automatically view a camera on the Ethernet-enabled screens



- OmniTouch Pro Software allows third party touchscreens to be used with Automation Studio Software
- The third party screen must be running at least Embedded XP, Vista, or Windows 7
- Once a screen is running the OmniTouch Pro software and the installation are validated via the internet, the screen can be discovered in Automation Studio

- OmniTouch Pro for installations can offer additional processing power and higher IP camera frame rates. In addition, OmniTouch Pro runs on full Windows operating system offering compatibility with Java, Flash and other browser plug-ins.

Snap-Link Mobile iOS & Android



- Access an Omni system from an iPhone, iPad, iPod or Android
- Designed specifically for touchscreen navigation
- View IP cameras from Leviton and EverFocus DVRs
- Control individual lights or turn off all lights in the home or an individual room
- Adjust temperatures in a room or throughout the home
- Arm or disarm the security, view open zones or view security logs remotely
- Control whole house audio and view what is currently being played in real time
- No server required

* iPhone, iPad and Android versions available through app stores

Snap-Link (1120)



- Access an Omni system from a LAN or the internet
- Expanded audio support
- Can be used with Ultra Mobile PC's for portable touchscreens
- View IP cameras
- No server required
- Send alerts via email, cell phone or pager
- Foreign language support

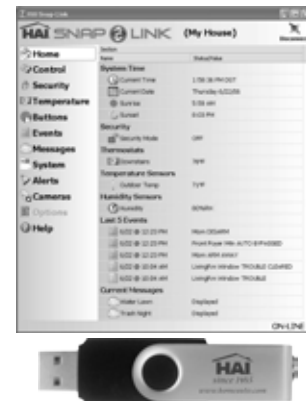

Pool / Spa Control from Jandy



BELJI7620

- The AquaLink Serial interface is a powerful, easy-to-program interface for controlling the Jandy AquaLink RS system
- While most integration projects with Leviton Security and Automation are set up to send instructions to the pool and/or spa, it is possible to poll the AquaLink RS for status and track the status in the Omni controller
- Tested for compatibility with Omni's Pro Link
- Simple ASCII Based Protocol: Use an LSA36A05-4 Connectivity Cable



BELJI7620	AquaLink RS serial adapter/home automation interface, allows RS-232 communication between Jandy AquaLink RS and LSA	557.98
LSA36A05-4	RJ-11 to DB-9M straight through connectivity cable. Use with AquaLink RS.	9.47

Automation
Water & Gas Control



LSA Compatible Water Sensors

GRI2600	Hardwired 12VDC water sensor	12.38
GRIT8000-G	Hardwired freeze sensor, 32-degree switch, NC	24.87
WIWB200	WaterBug 200, includes 1 sensor, expand to 6	52.96
WIW-S-U	Additional sensors for the WIWB200	16.24
RESRE119	Water and low temp sensor for GE wireless (LSASY422 compatible)	41.22

Omni Compatible Motorized Water Valves

GRNASV050	1/2" Motorized water valve, handle, power supply	337.40
GRNASV075	3/4" Motorized water valve, handle, power supply	375.92
GRNASV100	1" Motorized water valve, handle, power supply	317.46
GRNASV150	1 1/2" Motorized water valve, handle, power sup.	656.56
GRNASV200	2" Motorized water valve, handle, power supply	843.65
GRNASV075G	3/4" Motorized gas valve, handle, power supply	582.27
GRNASV100G	1" Motorized gas valve, handle, power supply	637.30

Give your home or business 24/7 protection from interior flooding with an Automatic Security Valve by GreenField Direct. Add it to your home control system and the water supply can be controlled remotely giving you total control from home or away.

- Integrates with Omni and other Automation Controls
- Fast Action Opening and Closing
- Possible Insurance Discounts
- Stainless Steel construction
- NSF mark ensuring the valve is safe for use with drinking water



Looking for a Z-Wave controlled water valve?

See FortrezZ on page 18

- Vacation homes need constant monitoring for low temperature, water damage, security and fire protection
- The Omni is perfect for monitoring and automating vacation homes
- Monitor for water leaks, flooding or low temperature conditions
- Install a temperature sensor in a closet. Program the water off if the temperature drops to 40°.
- Provide the homeowner home control via Snap-Link from the phone or with an Omni IIe/Pro II over the internet

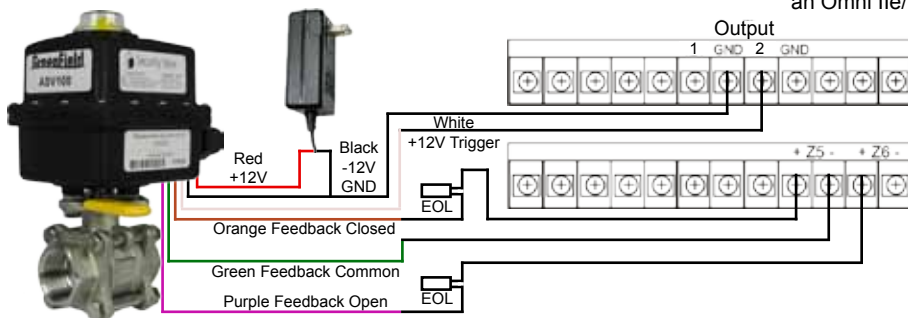

Valve	Function	Connected to
Red	Power (+) Positive	+12 VDC Supply
Black	Power (-) Negative	-12 VDC Supply & GND
White	+12 VDC trigger	+12 Output
Orange	Feedback closed	Zone +: EOL in series
Green	Feedback common	Zone -
Purple	Feedback open	Zone +: EOL in series

Note: Open/Close condition; the zone becomes 'Secure'

Automation
Sensors



SNCM-9-R

Low-Voltage Occupancy and Photocell

SNCM-9-R	12VAC/VDC Occupancy Sensor, 30 seconds to 20 min., SPDT relay, 13mA draw	82.43
SNCM-PDT-9-R	12VAC/VDC Occupancy Sensor w/ microphone, 30 sec.-20 min., SPDT, 13mA draw	107.41
SNCM-PC	12VAC/VDC Ceiling-mount photocell, SPDT relay, 15mA draw	62.45
SNWSD-LV-R*	12VAC/VDC Wall-Mount Occupancy Sensor w/ microphone (*W-White, I-Ivory, G-Gray, A-Almond)	82.43

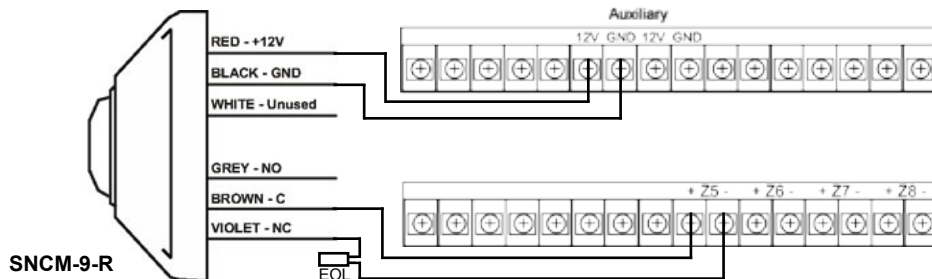

Connecting a CM-9-R to an Omni Panel
1) Power leads to +12V Aux and Gnd
2) NC output with EOL Resistor to Zone

Turning on a light when somebody enters a room is easy, but how do we know when the room is empty so the light can be turned off? Occupancy is the answer. Never leave a customer in the dark. Programming example:

Occupied - WHEN DenOcc NR: Den ON
Empty - WHEN DenOcc SECURE: Den OFF

Omni Controller Power Considerations

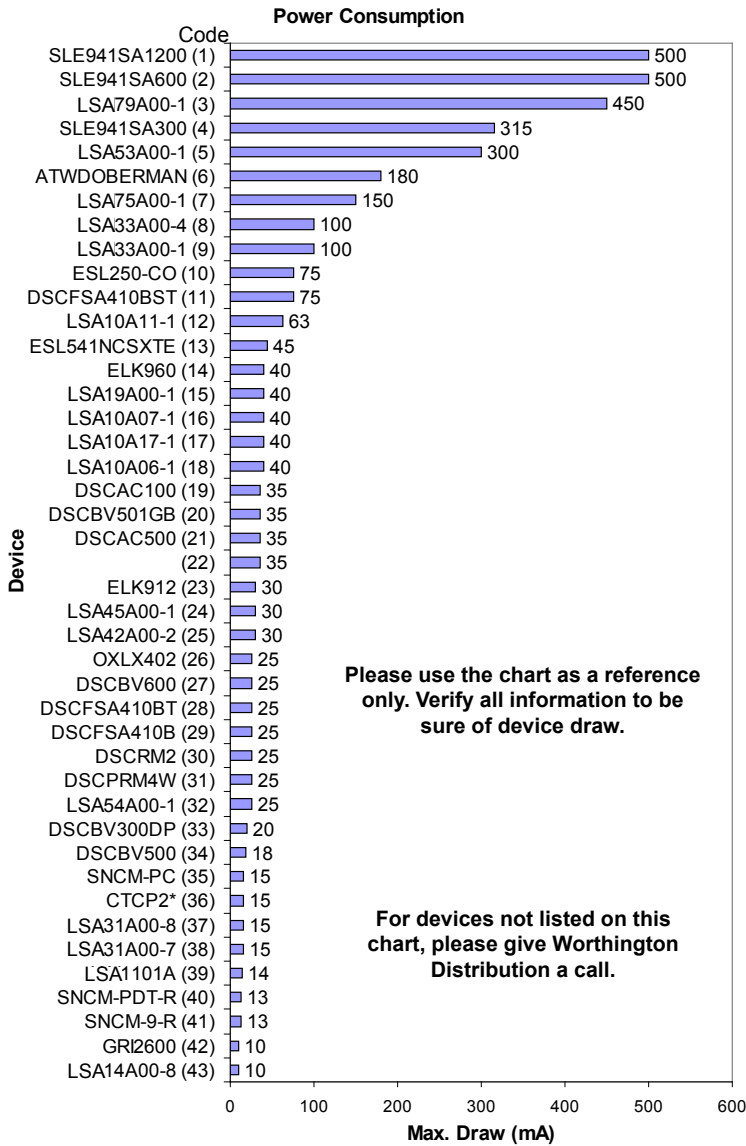

Please use the chart as a reference only. Verify all information to be sure of device draw.

For devices not listed on this chart, please give Worthington Distribution a call.

Omni Peripherals		Non-Omni Peripherals* (cont.)	
Code	Description	Code	Description
43	Water Temp. Sensor	19	Glass Break Detector
39	PESM	13	4-Wire Smk/Heat/Snd/Rly
38	Temp. Sensor	11	4-Wire Smoke/Heat/Snd
37	Temp./Humidity Sensor	10	CO Detector
32	Outdoor Keypad	6	Sounder w/Strobe
25	Wireless Receiver : Interlogix	Non-Omni Peripherals**	
24	Wireless Receiver: HAI	42	Water Detector
22		41	12V Occupancy Sensor
18	Hardwire Exp. (Ile/Proll)	40	12V Dual Tech. Occ.
17	RS232/RS485 Serial Exp.	36	Vehicle Detector
16	4-Relay Module	35	Photocell
15	8-Relay Module	23	Single Relay
12	Two-Way Voice Board	14	Delay Timer
9	LCD Console	4	300lb. Mag. Lock
8	LCD Console w/Spk./Mic.	2	600lb. Mag. Lock
7	Access Control Reader	1	1200lb. Mag Lock
5	OmniTouch 5.7 Console	*Should be powered by Omni	
3	Door Strike, Fail Secure	**Can be powered externally	
Non-Omni Peripherals*			
34	Ceiling Mount PIR	Chart Tip: If you do not know the part number of the item you need the current draw of, find the description in the table and use the code to match to the corresponding part number. Disclaimer: Please use the chart as a reference only. Verify all information to be sure of device draw. For devices not listed on this chart please give Worthington Distribution a call. For Omni see pages 53-72. For Altronix see page 102.	
33	Pet Immune PIR		
31	Polarity Reversal Module		
30	Power Supervision Module		
29	4-Wire Smoke		
28	4-Wire Smoke/Heat		
27	Dual Sensor PIR		
26	Outdoor PIR		
21	Glass Break Detector		
20	Glass Break Detector/PIR		

Power Consumption Worksheet (*Includes Console, Auxiliary, Switched and Outputs)

Panel	Aux Available*	Max. Bell Current	Panel	Available*	External	Available
OmniLTe	1A (1000 mA)	1A (1000 mA)	17A00	1.5A (1500 mA)	83A00-*	5A
Omni Ile	1A (1000 mA)	1A (1000 mA)	Requires separate battery and transformer.		Requires separate battery and transformer.	
OmniPro II	1A (1000 mA)	1A (1000 mA)				
Panel	Interior/Exterior	17A00	External			
	mA	mA	mA		mA	

Grounding External Power

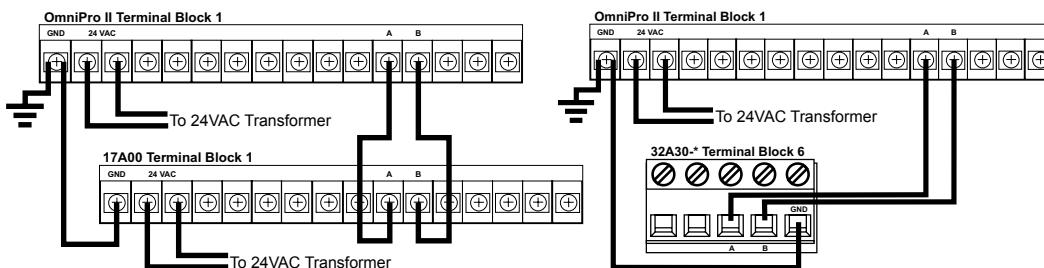

Third Party Power Supply (External)

- If the power supply has a GND terminal or green GND lead then ground the power supply to the GND terminal
- If the power supply does not have a ground, then ground the 12VDC minus (-) lead to the GND terminal
- Do not ground in the remote location
- Make certain the Pro II is grounded



The ELK M1 Control System provides flexibility to control a home or business. At its heart is a security system with over 30 years of design experience. M1's automation capabilities allow for customization to meet customer's changing needs. End users have system control from within the home or remotely. A variety of apps provide control and real-time notification without fee-based cloud services. A wide variety of keypad choices, including the "touch" keypad Navigator, enables dealers to satisfy clients' personal tastes as well.



Access Control:
 M1 access control solutions provide secure identity management allowing authorized personnel to enter secure areas, while preventing unauthorized individuals from entering.

Use ELK M1 readers or any 26-bit Wiegand reader



Interfaces:
 M1 provides consumers ease of use through remote and local control. The system operates with touch pads, LCD keypads, iPhone®, iPad®, Android® and other mobile devices.

M1 provides event notifications via text message, e-mail, or phone call.



Energy Management:
 Help customers control costs with "Green" technology solutions. Enable them to conserve energy and reduce

costs without compromising safety, convenience or comfort. M1 enables consumers to manage energy output, shrink carbon footprint, and lower utility bills. M1 energy management solutions provide control and scheduling capabilities for lighting, climate control, shades/blinds, electric water heaters, and other electrical devices.



Lighting:
 Lighting offers different things to different people. Homeowners want lighting that provides the right ambiance for their mood or activities. Business owners want lighting that attracts customers and creates a safe and effective work environment. Everyone wants to save on energy costs while maintaining safety and convenience.



Home and Business:
 M1 future proof systems provide consumers with the ability to control a home or business from a single, easy-to-use yet sophisticated control

solution. This M1 can control just about any electronic feature in the home or business, from sprinklers, to water valves, distributed audio, gates, doors, spas, and more.



Security:
 M1 gives you the ability to offer robust security solutions that your customers want and need. Whether a new or existing installation,

M1 offers hard-wired or wireless options including ELK's two-way wireless. The system provides a full range of detection and reporting capabilities.

ELK Partner Manufacturers		Connect Using	Page
Lighting			
Leviton	Vizia RF + Z-Wave	ELKM1XSLZW, LEVVR0P-1LW, LEVVRUSB-1US	12-13
GE and Jasco	Z-Wave Devices	ELKM1XSLZW, LEVVR0P-1LW, LEVVRUSB-1US	15
Evolve	Z-Wave Devices	ELKM1XSLZW, LEVVR0P-1LW, LEVVRUSB-1US	14
Lutron	RadioRA 2	ELKM1XSLU, LURRMAINREPWH	20-27
Centralite	JetStream, Elite XL	ELKM1XSP*	32-34
PCS	Pulseworx	ELKM1PCSPIM	28-29
Simply Automated	UPB	ELKM1PCSPIM	30
Access Control			
Seco-Larm	Deadbolts, Magnetic Locks, Door Strikes	Hardwired Output, Main Board or Output Expander	107
Communicating Locks			
Kwikset & Baldwin	Deadbolts and Entry Sets	ELKM1XSLZW, LEVVR0P-1LW, LEVVRUSB-1US	10
Yale	Deadbolts and Entry Sets	ELKM1XSLZW, LEVVR0P-1LW, LEVVRUSB-1US	11
Schlage	Deadbolts and Entry Sets	ELKM1XSLZW, LEVVR0P-1LW, LEVVRUSB-1US	11
Temperature Control			
Aprilaire	APR8800 Communicating thermostats	ELKM1XSP, APR8811, APR8819	81
Leviton Security and Automation	RC1000 or RC2000 thermostat	ELKM1XSP	61
RCS - RS485	RCSTR65 thermostat	ELKM1XSP*	80
RCS - Z-Wave	RCSTZ45 thermostat	ELKM1XSLZW, LEVVR0P-1LW, LEVVRUSB-1US	18
Evolve	EVOT-100R thermostat	ELKM1XSLZW, LEVVR0P-1LW, LEVVRUSB-1US	18
2GIG	2GIG-Z-CT100 thermostat	ELKM1XSLZW, LEVVR0P-1LW, LEVVRUSB-1US	18
Trane	SCHTZMT400 thermostat	ELKM1XSLZW, LEVVR0P-1LW, LEVVRUSB-1US	18
Lutron	RadioRA 2	ELKM1XSLU, LURRMAINREPWH	20-27

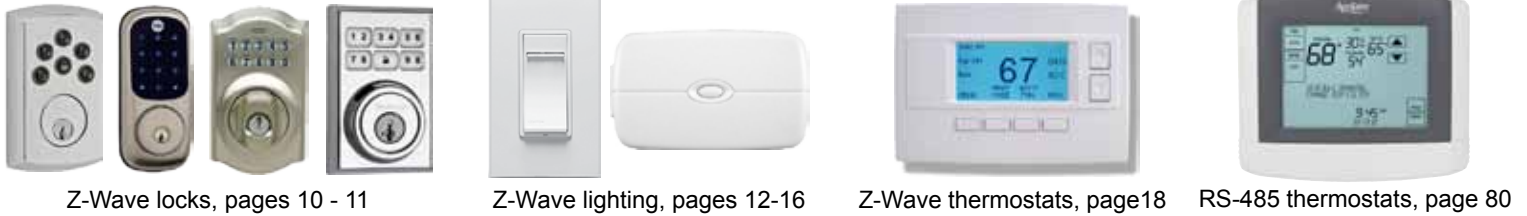

Z-Wave locks, pages 10 - 11

Z-Wave lighting, pages 12-16

Z-Wave thermostats, page 18

RS-485 thermostats, page 80

Wireless Sensors			
GE Crystal	GE Crystal or SAW Transmitters	M1XRFEG to Keypad Bus	96
Ion	GE Compatible Transmitters	M1XRFEG to Keypad Bus	99
Resolution Products	GE Compatible Transmitters	M1XRFEG to Keypad Bus	99
Wireless Networking			
Luxul Wireless	Enhanced Wi-Fi Access Points	iOS and Android Wireless Applications	49
Water Detection			
Winland	Waterbug	Hardwired Input	104
GRI	Water Sensor	Hardwired Input	103
Water Shutoff			
ELK	Water Shutoff Valve	Hardwired Output, Main Board or Output Expander	79
GreenField Direct	KZValve	Hardwired Output, Main Board or Output Expander	21
Whole House Audio			
Russound	MCA-C5, MCA-C3, CAA66, CAS44, CA4	M1XEP to Main Port, ELKIP232	119-122
Proficient	M4, M6	M1XEP to Main Port, ELKIP232	132
Exterior Detection			
Dakota Alert	Hardwired and Wireless Sensors	Hardwired Input	83
Cartell	Vehicle Detection Probes	Hardwired Input	82

* Application note available

Choosing Between the M1 Gold and EZ8

M1 Gold
M1 EZ8

Voice Capability		
• Voice Announcements		
• Alarms, descriptions, status, etc.		
• Built-in Telephone Remote Control		
• Integrated Voice Dialer		
On-board Input Zones / with maximum expansion	16 / 208	8 / 200
On-board Outputs / with maximum expansion	13 (1 form C relay) / 205	12 (1 form C relay) / 204
Built-in Serial Port	Yes	Requires an ELKM1EZ8MSI Main Serial Port Interface
Terminal Strips	Plug-in	Non-removable
Power Terminals	4 Total: 3 Auxiliary, 1 Switched	2 Total: 1 Auxiliary, 1 Switched
Master Power Switch and Low Battery Disconnect	Yes	Requires ELK-965
Inputs	Zone Voltage Display and Volt/Current Meter	Zone Voltage Display and Voltmeter
Two-Way Listen-In Capability	Central Station Alarm Verification User Activated through Telephone	Central Station Alarm Verification Only
Automation ("Whenever/And/Then") Rules Capacity	528	528
Keypads Supported	16	16
Flash Updated Firmware	Yes	Yes
Vocabulary	500+Word / Phrase	-
Custom Words and Phrases	Yes	-
Removable Terminal Strips	Yes	-
Serial (RS232) ports supported	8	8
Number of HVAC thermostats supported	16	16
Total hardwire zones on main controller	16	8
Total wireless zones	144	144
Total zones supported with all expansion	208	200
Total number of outputs supported	205	204
Total number of users supported	199	199
iPad / iPhone application compatible	Yes (requires the M1XEP)	Yes (requires the M1XEP)
Advanced lighting options	Yes	Yes
Analog zone definitions supported	Yes	Yes
Ability to create custom Serial ASCII strings	Yes	Yes
Z-Wave Lock Support	Yes	Yes
Sunset / Sunrise	Calculated	Calculated
Time/Date stamped Event History Log	512	512
Menu driven keypad programming	Yes	Yes
Smoke Detection	4 wire (any zone), 2 wire (zone 16)	4 wire (any zone), 2 wire (zone 8)
Security Partitions	8	8
Distributed Audio Support	Russound, Nuvo, Proficient	Russound, Nuvo, Proficient
Auxiliary Power	1 amp continuous	1 amp continuous
Overload Protection	PTC (fuseless), resettable	PTC (fuseless), resettable
UL Listings	Residential Burglary & Fire Commercial Burglary	-

ELK M1 Gold Cross Platform Controller

ELKM1GOLD	M1 Gold Controller in 14" Enclosure	511.77
ELKM1GCB	M1 Gold Control Board Only (in clam case). Terminal strips not included.	479.93
ELKM1BLOCKS	Replacement Plug-in Terminals for M1 Gold	20.33

ELK M1 Gold Kits

ELKM1GSYS3	M1 Gold in 14" Enclosure + Transformer + Battery + Speaker + RJ31X	550.60
ELKM1GSYS4	M1 Gold in 14" Enclosure + Transformer + M1KP Keypad + Battery + Speaker + RJ31X	710.34
ELKM1GSYS4S	M1 Gold in 14" Enclosure + Transformer + M1KP2 Keypad + Battery + Speaker + RJ31X	681.77
ELKM1GK	M1 Gold + Transformer + M1KP Keypad + Battery + Speaker + RJ31X, No Enclosure	679.93
ELKM1GKS	M1 Gold + Transformer + M1KP2 Keypad + Battery + Speaker + RJ31X, No Enclosure	651.36

ELK M1 EZ8 Cross Platform Controller

ELKM1EZ8CB	M1 EZ8 Control Board Only	285.64
------------	---------------------------	--------

ELK M1 EZ8 Kits

ELKM1EZ8KB	M1 EZ8 in 12" Enclosure + Transformer + M1KP Keypad + Battery + Speaker + RJ31X	518.66
ELKM1EZ8KBS	M1 EZ8 in 12" Enclosure + Transformer + M1KP2 Keypad + Battery + Speaker + RJ31X	490.09



- Hi-Contrast LCD Touchscreen Display
- Six (6) Programmable Function Keys
- Unique "Menu" Navigation
- Uses 4-wire RS485 Data Bus
- Built-in Piezo Sounder with Adjustable Pitch
- One (1) Supervised Zone Input
- One (1) "Switched Positive" Voltage Output
- Screen Size: 3.5" Diagonal
- Overall size: 4.25"W x 3.38"H x .59"D



ELKM1KPNAV

ELK M1 Navigator Touchscreen

ELKM1KPNAV	Navigator 3.5" Color Touchscreen Keypad	264.29
------------	---	--------

ELK M1 Navigator Touchscreen Accessories

ELKM1BBKN	Back Box for M1KPNAV, on non-hollow walls	9.93
ELKM1BZBKN	(2) Black Color Change Kits for the M1KPNAV	17.07
ELKM1BZSKN	(2) Silver Color Change Kits for the M1KPNAV	17.07

ELK M1 and EZ8 Keypads

ELKM1KP	Keypad, 16 character, 2-line Green LCD	165.64
ELKM1KPB	Keypad, 16 character, 2-line Blue LCD	165.64
ELKM1KP2	Keypad, 16 character, 2-line Blue LCD, flush opt.	137.07
ELKM1KP3	Keypad, 16 character, 2-line Blue LCD, surface	149.93
ELKM1KPAS	Decorator Arming Station, status LEDs	88.50

ELK M1 and EZ8 Keypad Accessories

ELKM1BBK2	Flush mount backbox for the M1KP2 keypad	7.79
ELKM1PR	Internal proximity reader for M1KP keypad	77.07
ELKW035A	Wire harness for connecting a 26 bit Wiegand reader to an M1KP or M1KPB keypad	3.57
ELKW039A	Wire harness for connecting a 26 bit Wiegand reader to an M1KP2 or M1KP3 keypad	3.57

**ELK requires we publish MAP pricing.
For your low ELK Dealer Pricing:**

- Log into your Worthington Distribution on-line account
- Call 800-282-8864 to request ELK Dealer pricing sheets



M1KPAS



M1KP3



M1KP



M1KP2

ELK M1 and EZ8 Keypad Comparison

	ELK-M1KP / B	ELK-M1KPAS	ELK-M1KP2	ELK-M1KP3	ELK-M1KPNAV
Physical Dimensions	6.87"W x 5.25"H x 1.32"D	1.81"W x 2.75"H x 1"D	4.65"W x 5.5"H x 1.32"D	3.97"W x 5.43"H x 1.19"D	4.25"W x 3.38"H x .59"D
Door Cover	Yes	No	No	Yes	No
Zone Input	Yes (1)	No	Yes (1)	Yes (1)	Yes (1)
Programmable Output	Yes (1)	No	Yes (1)	Yes (1)	Yes (1)
Optional 26-Bit Wiegand Proximity Reader	Yes- Internal & External	No	Yes- External Only	Yes- External Only	No
Internal Temp Sensor	Yes	No	No	No	No
Function "F" Keys	6	6- Press "F" Key, then 1-6	4	4	6
LCD Display	Green / Blue	N/A	Blue	Blue	Full Color, Touch
Key Backlighting	Amber	Blue	Blue	Blue	N/A
Mounting Options	Surface Mount Only	Standard Electrical Box	Surface or Flush with M1BBK2	Surface Mount Only	Surface Mount Only

ELK M1 Ethernet Interface

ELKM1XEP	Ethernet Port: Network connection for programming, monitoring, E-mail notification, and web browser interface. An M1EZ8MSI is required when connecting to an M1XEZ8.	234.21
ELKW040A	Replacement serial cable for connecting an M1 serial port to an M1XEP	8.57

ELK M1 Serial Interfaces

ELKM1XSP	3-in-1 Expander: Serial, Lighting and Thermostat Interface	109.93
ELKM1EZ8MSI	Adds a serial port to the EZ8, plugs into RJ-45, pass through for X-10, 1 per M1 EZ8	42.79

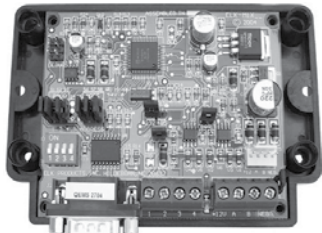

ELKM1XSP



APR880

See page 81 for Aprilaire thermostats

ELK requires we publish MAP pricing.
For your low ELK Dealer Pricing:

- Log into your Worthington Distribution on-line account
- Call 800-282-8864 to request ELK Dealer pricing sheets

ELK M1 Z-Wave Interface

ELKM1XSLZW	M1 to Z-Wave serial interface, LEVVR0P-1LW required, program with the LEVVRUSB-1US	149.93
LEVVR0P-1LW	Z-Wave serial interface	89.15
LEVVRUSB-1US	PC USB adapter for programming with Vizia RF+ Installer software	69.92

Download Leviton's free software <http://www.leviton.com/rfinstaller>

ELK M1 Integration Interfaces

ELKM1XSLU	M1 to Lutron RadioRA 2 serial interface	299.93
ELK101236	NESS Square D/Clipsal Lighting Interface	314.21

ELK M1 Serial to IP Interface

ELKIP232	Create a serial connection over IP, typically required for Distributed Audio integration	157.07
----------	--	--------

ELK M1 Proximity Access Control

ELKM1PRC	Pack of 10 Proximity Cards	42.14
ELKM1PRF	Pack of 10 Proximity Fobs	71.36
ELK106055	Surface mount prox reader for ELKM1KAM or M1 keypad (not M1KPAS or M1KPNV)	85.64



ELKMA110



ELK106055

ELKM1PRC
ELKM1PRF

ELK Structured Wiring Enclosures

ELKSWB14	14" Structured Wiring Enclosure, hinged door	40.30
ELKSWFD14	Flush Mount Door for the 14" Enclosure	30.33
ELKSWB28	28" Structured Wiring Enclosure, hinged door	101.09

ELK Mounting Accessories

ELKSWNS1	Nylon standoffs, 1/4" spacing, fits .156" hole	6.77
ELKSWNS	Battery Shelf	13.77
ELKSWP3	Mounting plate for M1 boards	9.66

ELK M1 Input (Zone) and Output Expanders

ELKM1XIN	Zone expander, 16-zone	102.79
ELKM1XOVR	Output expander, 8 Relays, 8 voltage outputs	152.79
ELKM1RB	Relay board, 8 form "C" relays for use with ELKM1XOVR, or M1 Controller	80.71
ELKW018B	4-pin cable for connecting expanders at the M1 controller	3.84

ELK M1 Databus Wiring Hubs

ELKM1DBH	Passive Wiring Hub: Use with 8 conductor cable (Cat 5) to connect keypads and expanders	42.59
ELKM1DBHR	Active Keypad Databus Hub. Connect 4 bus branches per hub (2 hubs per system)	78.50

ELK M1 Two-Way Voice Amplifier Interface



ELKM1TWA

- Supports 3 zones, up to 12 microphones
- Each speaker output can drive 4Ω to 32Ω
- ½ watt per speaker channel
- Each zone can be muted individually
- Up to 4 microphones on each microphone channel
- Current draw: 15mA nominal, 1000mA (1 Amp) maximum

ELK M1 Two-Way Voice Accessories

ELKM1TWK	M1G Two-way Voice Kit: M1TWI, M1TWS	71.36
ELKM1EZ8TWK	Two-way Listen-In Kit for EZ8	71.36
ELKM1TWS	Two-way surface mount speaker/microphone	29.43
ELKM1TWSF	Two-way flush mount speaker/microphone	22.00
ELKM1TWM	Two-way listen-in microphone	23.20
ELKM1TWI	M1G Two-way voice interface	53.57
ELKM1TWA	Two-way amplifier interface: 3 speaker, 3 mic	94.21

ELK M1 Temperature Accessories

ELKM1ZTS	Temperature Sensor, Max 1 per Zone, wire to Zones 1-16	77.07
ELKM1ZTSR	Remote Temp Sensor, Stainless Steel bullet on a 7' cable, Max 1 per Zone, wire to Zones 1-16	108.50

ELK M1 Door Access Module

ELKM1KAM	Door Access Module: Use instead of a keypad, support for 26 bit Wiegand readers, Dallas iButton, Form "C" Relay, 3 Indicator outputs, 2 inputs and selectable time settings for door hold and request to exit	127.86
----------	---	--------

- Input for a 26 bit Wiegand Reader
- Input for a Dallas "One-Wire" iButton Reader
- Heavy Duty Form "C" Relay Contacts
- 3 Low Current Switched Outputs
- Supervised Input for RTE (Request To Exit) Button
- Supervised Input for Door Status Sensor
- Connects to the RS-485 4-Wire Keypad Data Bus



ELKM1KAM

Need mag-locks or door strikes devices for your ELK system?
See page 107 for more details.

ELK M1 Motorized Water Valve

ELKWSV	12VDC Water Valve with 1" fittings	471.36
MGSPS-12DC-2A	12VDC 2 Amp Power Supply	11.55

- Rapid Action - Opening or Closing
- Connections: 18 gauge, 4 conductor cord
- Stainless Steel Grade 316 Safe for Drinking Water



ELK Heavy Duty Relay / Contactor

ELK9200	60 Amp double pole relay with 110VAC coil in an enclosure. Plug into an appliance module for control of 110/220 VAC high current loads.	86.47
---------	---	-------

ELK Power Supply

ELKP212S	Supervised 2 Amp power supply, 12VDC, 16.5VAC 40VA transformer and 12VDC 8Ah battery required; not included	160.39
----------	---	--------

ELK M1 Software

ELKRP	Programming software (Free download)	On-Line
ELKRM	ELKRM PC Edition Remote Management; also works on Windows Touchscreens	149.95
ELKUSB232	USB to RS-232 Serial adapter	34.21

M1ToGo Free PC Software

M1ToGo software provides internet remote access from a Windows® based PC to M1 systems from anywhere in the world. Users can access security, lighting, energy management, door/gate access and any other system connected and controlled through the M1. M1ToGo is downloaded from the ELK web site.



**ELK requires we publish MAP pricing.
For your low ELK Dealer Pricing:**

- Log into your **Worthington Distribution** on-line account
- Call **800-282-8864** to request **ELK Dealer pricing sheets**

Apple iOS Interface Solutions



eKeypad is a family of applications available through the Apple App Store that provide M1 mobile access and control of home automation, security, surveillance, energy management and audio/video systems.

eKeypad Graphic Services

Transform line drawings into a gorgeous, custom interface

In addition to standard iOS apps, eKeypad offers an interface module called Blueprints. Blueprints allows dealers to provide a customized GUI for the iPad that competes with interfaces offered by systems at any price. The eKeypad staff starts with architectural drawings and converts them to works of art. eKeypad control is added to the floorplan for a beautiful custom interface.

Call for a custom quote



ELK M1 2-Way Wireless Receiver

ELKM1XRFTW	144 zone 2-way wireless transceiver. For use with Elk 2-way transmitters.	142.79
------------	---	--------



ELK Products offers two-way wireless technology for the M1 Control that revolutionizes the reliability and functionality of wireless peripherals for homes and businesses.

- Full, true two-way signal acknowledgement
- Utilizes 900 MHz frequency-hopping spread spectrum to increase signal diversity and agility to make sure that signal gets through
- Constantly monitors and adjusts ideal RF power level to deliver clear signal while maximizing battery life
- Assures installation confidence through signal quality and status LED





The M1XRFTW two-way wireless transceiver allows an ELK M1 Gold or EZ8 to accept ELK's line of two-way wireless sensors.

- Operating Frequency: 902 Mhz to 928 Mhz
- Operating Temperature: 0° to +120°F
- Current Draw: 25mA receiving, 85mA transmitting
- Housing Dimensions: 6.5" x 4.5" x 1"
- Allows up to 144 individual wireless zones (sensors/points)
- Operates from the 4-wire RS-485 Data Bus
- Up to 4 receivers may be connected to a single M1 or M1EZ8 control for redundancy and greater coverage
- Flash memory for firmware updates

ELK M1 2-Way Wireless Devices

ELKELK6010	2-way, four button keyfob	61.36
ELKELK6020	2-way, slim line door/window sensor	59.93
ELKELK6021	2-way, mini door/window	55.64
ELKELK6022	2-way, universal 3-zone sensor	78.50

Additional 2-way sensors including PIR, glass break, water, temperature, sounder and smoke detector are expected in 2013, please call for updates

 <p>Four Button Keyfob</p> <ul style="list-style-type: none"> • 4 push buttons • LED feedback indicator • Arm, disarm, check status, and trigger a panic alarm • 5 year permanent battery 	 <p>Mini Sensor</p> <ul style="list-style-type: none"> • Ideal for casement and double hung window applications • Built-in reed switch • 3/8" reed switch gap
 <p>Slim Line Sensor</p> <ul style="list-style-type: none"> • Ideal for door and window applications • Built-in reed switch • Front and back tamper • 1/2" reed switch gap 	 <p>Universal Sensor</p> <ul style="list-style-type: none"> • Built-in reed switch • 2 external closed circuit zone inputs • Front and back tamper • 1/2" reed switch gap

ELK M1 Wireless Receivers

ELKM1XRFEFG	144 zone Wireless receiver. For use with Interlogix crystal and SAW transmitters.	142.79
ELKM1XRF2H	144 zone Wireless receiver. For use with Honeywell 5800 series transmitters.	142.79

Thermostats



RCSTR65

RCSTR16	Serial thermostat with RS-485 interface, includes TS16 wall display unit and control unit with RS-485 interface. RS-232 Converter required for PC's and RS-232 controllers.	167.68
RCSTR65	Serial thermostat with RS-485 interface, includes TS65 wall display unit and control unit with RS-485 interface. RS-232 Converter required for PC's and RS-232 controllers.	186.41
RCSTZ45	Z-Wave thermostat, all-in-one unit with full WDU. Connect directly to HVAC system.	139.58

Remote Temperature Sensor Configurations

Use the list below to correctly determine which temperature sensor to use for your application: RS15 sensors can be used with TS16 and TS40 WDUs; OS5 sensors are used with ZCVx model HVAC control units for outside temperature. RTS3 and RTS4 sensors are for TS65 WDUs.

RCSRS15	Remote temperature sensor, wall-mount, 4 wires to WDU for TS16/TS40	55.27
RCSOS5	Outside temperature sensor for ZCV2/4/6 control units	27.17
RCSRTS3	Remote temperature sensor for TZ45 (up to 2) and WDUs supporting 2-wire sensors-flush	23.42
RCSRTS4	Remote temperature sensor for TZ45 (up to 2) and WDUs supporting 2-wire sensors-surface	23.42



RCSRTS4

Wall Display Units

Wall display units must be used in conjunction with a ZCVx zone controller. Two models are available, the TS16 and the TS65. The TS65 is an enhanced version of the previously available TS40 WDU. See above section for remote temperature sensor use.



RCSTS16



RCSTS65

RCSTS16	Wall display unit, LCD, RCSLink2, requires controller, supports 4-wire temperature sensor	74.00
RCSTS65	Wall display unit, graphical LCD, RCSLink2, requires controller, supports 2-wire temperature sensors	92.74

Standard HVAC Zone Control Units

RCSZC2S	HVAC 2-zone controller for STD gas/electric systems only	139.58
RCSZC4	HVAC 4-zone controller for STD or heat pump HVAC systems	186.41

Can be used with any RCS Communicating Thermostat.

Zone Control Unit Transformers

ELKTRG2440	Plug-in transformer, 120/24VAC, 40VA	14.14
------------	--------------------------------------	-------

Z-Wave Large Load Control and Power Monitoring



RCSPC30	Z-Wave Controlled 30 Amp Contactor 120/208/240 VAC	186.41
RCSPMC30	Z-Wave Controlled 30 Amp Contactor 120/208/240 VAC with current sensing	214.52

Use PMC30 only with controllers from MiCasaVerde.

Dampers

RCS6RD*	6" round, spring return, 24VAC, 2-wire	82.43
RCS8RD*	8" round spring return, 24VAC, 2-wire	84.31
RCS10RD*	10" round spring return, 24VAC, 2-wire	92.74
RCS12RD*	12" round spring return, 24VAC, 2-wire	102.11
RCS14RD*	14" round spring return, 24VAC, 2-wire	111.47
RCS16RD*	16" round spring return, 24VAC, 2-wire	120.84
RCS6RDM*-FP	6" round modulating, 24VAC, 3-wire	149.88
RCS8RDM*-FP	8" round modulating, 24VAC, 3-wire	154.56
RCS10RDM*-FP	10" round modulating, 24VAC, 3-wire	159.25
RCS12RDM*-FP	12" round modulating, 24VAC, 3-wire	163.93
RCS14RDM*-FP	14" round modulating, 24VAC, 3-wire	168.62
RCS16RDM*-FP	16" round modulating, 24VAC, 3-wire	173.30
RCS8RDB	8" round, barometric bypass	55.27
RCS10RDB	10" round barometric bypass	60.89
RCS12RDB	12" round barometric bypass	65.57
RCS14RDB	14" round barometric bypass	70.26

Replace * with NO for Normally Open or NC for Normally Closed

18" and 20" modulating dampers also available.

Worthington carries the full RCS product line. Call or visit our online Dealer Store for details.

Remote Temperature Monitoring



RCS TZ45 Z-Wave Enabled Thermostat

Whether you have a vacation home or just your main home, keeping an eye on the temperature is important for both comfort and protection from damage.

Coming home to a house that is too warm or too cold is never a comfortable experience. By using communicating thermostats in conjunction with an automation controller (Mi Casa Verde, Somfy TaHomA, or HomeSeer), you have the ability to not only see the temperature but to also set it to a level that suits you from anywhere in the world before you arrive.

Not just for comfort. Protect your investments by being able to see if the temperature is getting too low which could lead to pipes freezing and water damage, or if it is getting too high which could damage electronics and other devices.

Questions regarding Remote Temperature Monitoring? Give us a call today!

Aprilaire Communicating Thermostat and Accessories

Aprilaire 8800 thermostat

- 10.3 square inch backlit display allows the thermostat and messages to be easily read during the day or night
- One thermostat solution: single-stage, dual-stage, heat pump, dual transformer, radiant heat, and radiant heat w/ second stage heat and 1-stage cooling
- Multi-stage applications; 2 Heat/2 Cool, or HeatPump 4 Heat/2 Cool
- Compatible with AMX, BitWise controls, CentraLite, Charmed Quark, Cinemar, Compass Control, 3vNet, Control4, Cortexa, Crestron, Elan, Elk Security, Home Automated Living, HomeSeer, HomeVision, iRule, Lutron (Homeworks), NetStreams, OnControls, RedEye Pro, RTI, Savant, and Vantage.
- Message Center feature allows an automation controller to send custom text to the display
- Built-in communication card allows distances of 4000 feet

APR8800	Universal Communicating Programmable Touchscreen Thermostat 2 Heat / 2 Cool, or Heat Pump 4 Heat / 2 Cool)	256.72
APR8826	Automated HVAC System Controller (see inset)	663.47
APR8081	Temperature support module, supports 2 temperature readings (8051, 8052, 8053) for averaging and/or monitoring	62.97
APR8082	Temperature/relative humidity module, supports 1 temp. and 1 RH reading, can be remoted using 8051, 8052, 8053	107.55
APR8051	Flush-mount temperature sensor for use with 8800, 8081/82	16.14
APR8052	Duct-mount or outdoor temp sensor for use with 8800, 8081/82	5.24
APR8053	Surface-mount temperature sensor for use with 8800, 8081/82	11.52
APR8819	Communication distribution panel - supports 8 thermostats	110.37
APR8029	24VAC, 40VA transformer with protection	16.11
APR8811	RS-485 to RS-232 Protocol Adapter - supports 32 thermostats	104.92
APR8024	Universal 3-SPDT Relay Pack	24.92



APR8051



APR8800



APR8819



APR8826

Aprilaire's Automated HVAC System Controller: APR8826

The system controller, integrated with Aprilaire's Communicating Thermostats, creates a turnkey home or building HVAC automation system that is simple and affordable for your customer to use.

Conveniently control and manage thermostats through your web browser

- Saves Energy - Schedule all thermostats easily to save energy
- Simple to use point and click interface
- 5 year warranty



APR8081

Non-Communicating Thermostats

APR8620	Universal Touchscreen thermostat - 2 Heat / 2 Cool, or HeatPump 4 Heat / 2 Cool	143.64
APR8910	Home Comfort Control, User Interface and the Equipment Control Module	193.58
APR8710	Wireless Programmable Thermostat - 2 Heat / 2 Cool or HeatPump 3 Heat / 2 Cool	145.01
APR8444	Standard Non-Programmable Thermostat - 1 Heat / 1 Cool	34.69
APR8446	Heatpump Non-Programmable Thermostat - 2 Heat / 1 Cool	37.97
APR8448	Universal Non-Programmable Thermostat - 2 Heat / 2 Cool or HeatPump 3 Heat / 2 Cool	50.32
APR8463	Standard Programmable (5+2 Day) Thermostat - 1 Heat / 1 Cool	47.82
APR8465	Heatpump Programmable (5+2 Day) Thermostat - 2 Heat / 1 Cool	49.03
APR8466	Universal Programmable Thermostat - 2 Heat / 2 Cool or HeatPump 3 Heat / 2 Cool	60.39



APR8710



APR8400 Series

The Aprilaire Model 8910 Home Comfort Control consists of two components, the User Interface and the Equipment Control Module. The User Interface, located in the living space, integrates all indoor air quality functions – heating/cooling, humidification/dehumidification, air cleaning and ventilation in one attractive, easy-to-use, touchscreen control. The User Interface offers homeowners the ability to easily set all of their IAQ and HVAC products from one location in the living space. The primary screen indicates how to easily activate and control set points. In addition, the display provides the homeowner with confirmation that the equipment is operating at the desired control settings.

Damper Controllers - Looking for a Controller Not Listed? Please Call.

APR6202	Electronic Damper Controller: 2 Zone, Single Stage, not for use with heat pumps	81.18
APR6203	Electronic Damper Controller: 3 Zone, Single Stage, not for use with heat pumps	89.43



APR6203

Round Motorized Dampers - Looking for a Damper Not Listed? Please Call.

APR6606	6" Diameter Motorized Damper, normally open, 2 conductor control, power close: 12VA @ 24VAC	71.94
APR6508	8" Diameter Motorized Backflow Damper for 1750/1770 dehumidifier, normally closed, can pull air from the primary living space or from the return of the HVAC system	75.78
APR6610	10" Diameter Motorized Damper, normally open, 2 conductor control, power close: 12VA @ 24VAC	80.88
APR6612	12" Diameter Motorized Damper, normally open, 2 conductor control, power close: 12VA @ 24VAC	85.23



Round Motorized Damper

Self-Contained Vehicle Sensors - Bury 50' from Cross-Traffic

CTCP-3-100-5W	Self-contained unit with 100' cable, power supply required, can be powered from security controller board	156.44
CTCP-3-200-5W	Self-contained unit with 200' cable, power supply required, can be powered from security controller board	217.33
CTCP-3-300-5W	Self-contained unit with 300' cable, power supply required, can be powered from security controller board	281.02
CTCP-3-500-5W	Self-contained unit with 500' cable, power supply required, can be powered from security controller board	405.61
MGT12500SPS	Power supply for self-contained CarTell detector, 12VDC 500mA	4.93

Installation is as simple as burying the probe, which is 21" long and 2" diameter, 6" to the side of the driveway. Bury the included and connected direct burial wire up to the house. Then connect two conductors to a 12VDC power supply, and the remaining two conductors to an input of your favorite controller. Also connects directly to gate operators to provide free exit.



Controllers - Use with CT6 and Short Driveway Probes

CT2B	Controller, adjustable sensitivity, enclosure, power supply, manual	137.70
CTCF2C	Controller, adjustable sensitivity, 15A/120VAC timer relay, enclosure, power supply, manual	223.88

When using the CT2B/CTCF2C controller, mount the controller next to the security system or automation controller. Splice using only CTCA1. Multiple probes can be wired to a controller; the controller closes a contact when motion is detected on any of the probes.



CT6 Probes - Bury 50' from Cross-Traffic

CT610	Probe with 10' cable, requires a CarTell controller, use CT2B or CTCF2C listed above	33.72
CT650	Probe with 50' cable, requires a CarTell controller, use CT2B or CTCF2C listed above	44.96
CT6100	Probe with 100' cable, requires a CarTell controller, use CT2B or CTCF2C listed above	61.83
CT6150	Probe with 150' cable, requires a CarTell controller, use CT2B or CTCF2C listed above	78.69
CT6200	Probe with 200' cable, requires a CarTell controller, use CT2B or CTCF2C listed above	95.55
CT6250	Probe with 250' cable, requires a CarTell controller, use CT2B or CTCF2C listed above	112.41
CT6500	Probe with 500' cable, requires a CarTell controller, use CT2B or CTCF2C listed above	196.72
CT61000	Probe with 1000' cable, requires a CarTell controller, use CT2B or CTCF2C listed above	365.33
CT61500	Probe with 1500' cable, requires a CarTell controller, use CT2B or CTCF2C listed above	533.95
CT6A	Detached probe, requires a CarTell controller and CarTell direct burial wire	66.51
CTCA1	Epoxy-based splice kit, 3M product	49.96



Short Driveway Probes - Bury 10' from Cross-Traffic

CTSD610	Short driveway probe with 10' cable, requires a CarTell controller, use CT2B or CTCF2C listed above	86.18
CTSD650	Short driveway probe with 50' cable, requires a CarTell controller, use CT2B or CTCF2C listed above	97.42
CTSD6100	Short driveway probe with 100' cable, requires a CarTell controller, use CT2B or CTCF2C listed above	112.41

Annunciator Plates

CTA1	Sleek hardwired annunciator, mounts in 1-gang box, volume control and mute, 3 tones to identify different driveways	63.70
CT-11	Outdoor annunciator plate, weatherproof	61.83

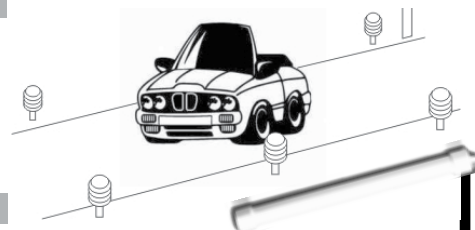

Photocells

CTFC6	Self-stick Photocell, attaches to inside of window, use with CTCF2C	11.24
CTFC12	Outdoor photocell, weatherproof, use with CTCF2C	32.79

Dealers will tell you that vehicle detection is the one system enhancement that all customers rave about. Worthington Distribution endorses CarTell vehicle detectors by Preferred Technologies for their outstanding performance. CarTell vehicle detectors provide annunciation, the ability to perform lighting control and video switching control. The CP3 is simple to install. Just bury the probe alongside the driveway, about 40 feet away from the road, and run the attached direct burial wire to the house. Connecting the CP3 is easy. Two wires are for 12VDC power and the remaining two wires provide a dry contact closure output.

- ATW PB-005** Annunciation Options
- Post a keypad message
 - Add an ATW sounder - see page 94

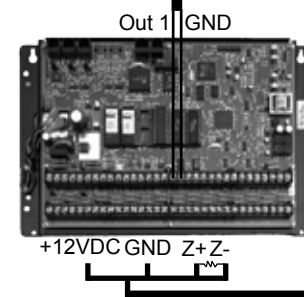

Driveway
Motion
Detected



Connecting Dakota Alert to HAI

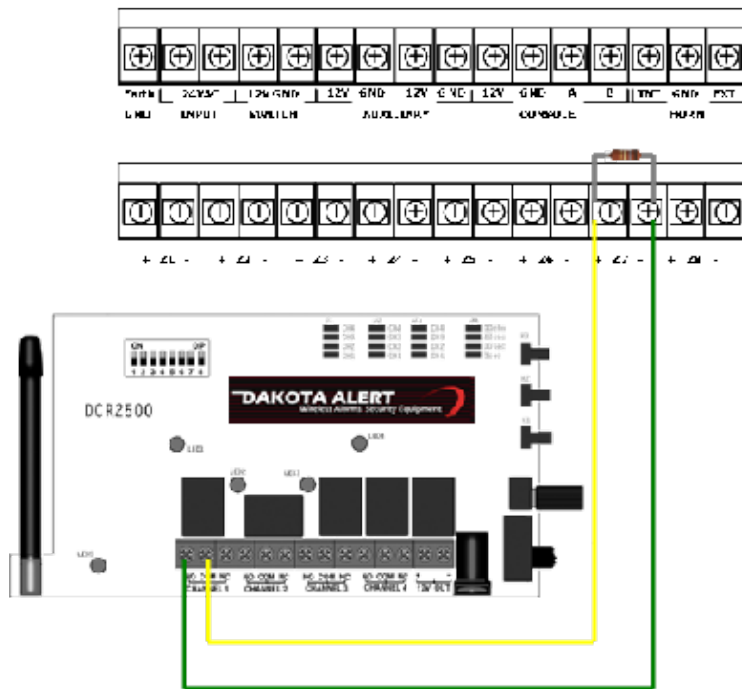

Mix and match up to four 2500 transmitters per DCR-2500.

3000 Series Wireless Alerts (600' Range*)

DAWPA-3000	Wireless Driveway Probe Alert, 50' Cable, transmitter and receiver, includes 4x CR123-A batteries	192.35
DAWPT-3000	Extra Transmitter for WPA-3000, for use on second driveway, includes 4x CR123-A batteries	157.37
DAWMA-3000	Wireless Motion Alert, transmitter and receiver, requires one 9V battery	106.16
DAWRH-3000	Wireless Rubber Hose Alert, transmitter and receiver, requires one 9V battery	123.03
DAIRWR-3000	Wireless PIR Sensor, 3 sensitivity settings, transmitter and receiver, requires one 9V battery	93.68
DAUT-3000	Universal Transmitter, push button for panic/doorbell and NC and NO contacts, transmitter only, requires one 9V battery and the WR-3000 receiver	29.98
DAWR-3000	Extra Receiver for WPA, WRH, WMA, IR and UT, up to 4 zones can be monitored	49.95

Accessories

DABH-1-UF	Birdhouse cover for WMT, WPT, WHT, MAT and MAPS, unfinished kit	9.37
DACA-01	Cable Alarm, secure devices like camera, firearms, etc.	29.98

Batteries (Driveway Probes include 4x CR123-A batteries)

UB6AM-6ALK	9V alkaline battery, each	1.58
UBAM2	"C" 1.5V alkaline battery, 2-pack	1.50
UBD5312	"AA" 1.5V alkaline battery, 2-pack	0.40
UBD5313	"AAA" 1.5V alkaline battery, 2-pack	0.40

2500 Series and Other Devices (1/2 mile range*)

DADCPA-2500	New Wireless Driveway Probe Alert, 50' Cable, transmitter and receiver, includes 4x CR123-A batteries, 1/2 mile range*, reminder beep/LED and counter	176.11
DADCMA-2500	Wireless Motion Alert, 1/2 mile range*, transmitter and receiver, requires one 9V battery, reminder beep/LED and counter	96.17
DADCMT-2500	Extra Transmitter for DCMA-2500	61.20
DADCP-2500	Extra Transmitter for DCPA-2500	141.14
DADCR-2500	Extra Receiver for 2500 series	49.95
DADVR-01	Mini DVR Camera, record 30 seconds at a time of video and audio based on motion	82.43
DAUT-2500	Universal Transmitter for use with 2500 series receivers. Push button can be used as Panic Button or as a Wireless Doorbell. Includes magnet for use as Wireless Door Contact. Also contains inputs for both N/C and N/O sensors.	29.98
DADC-1000	Wireless Door Chime, 16 tunes	36.22
DADCPB-1000	Additional push button for above, max. 4	9.99
DAEA-10	Entry Alert, self contained chime, 80dB	11.24



DADCMA-2500

DADVR-01

DAUT-2500

MURS (Multi-Use Radio Service) Alert (Several mile range*)

DAMAT	MURS PIR transmitter, for mounting on a tree or post, requires six AA batteries	98.67
DAM538-BS	MURS Base Station Transceiver, receives alerts from MURS devices as well as two-way communication w/ other transceivers, NO output	64.95
DAM538-HT	MURS Hand-Held Transceiver, receives alerts from MURS devices as well as two-way communication w/ other transceivers, includes charger and batteries	73.63
DAMURSHTKIT	MURS MAT Kit, includes one PIR transmitter and one M538-HT transceiver	164.87
DAMURSBKIT	MURS MAT Kit, includes one PIR transmitter and one M538-BS transceiver	158.00
DAMAPS	MURS Alert Probe Sensor transmitter, 50' direct burial cable	198.59
DAMAPSHTKIT	MURS MAPS Kit, includes one probe transmitter and one M538-HT transceiver	264.16
DAMAPSBKIT	MURS MAPS Kit, includes one probe transmitter and one M538-BS transceiver	255.42
DAMURSCHIME	MURS Chime Module for M538-BS, connects to NO output, requires two AA batteries	11.24

***Range varies due to terrain and other objects that can cause RF interference.**

PERS with Interactive and Environmental Sensors

AmberSelect-X

AmberSelect-X is a complete, affordable Personal Emergency Response System (PERS). It includes the capabilities families want most in a single, easy-to-sell and install package including:

- Wireless environmental safety detection: smoke, flood, intrusion and CO
- Wireless fall monitoring
- Programmable inactivity monitoring
- Medication and daily task reminders
- Reports to a central station
- One-button emergency dialing
- Clear, voice prompted menus
- Two-way speakerphone
- Programmable speed dial numbers
- POTS line required
- PC programmable

VISAMBERX	Advanced console, two-way voice, waterproof wristband or pendant transmitter, battery pack, phone line, program cable, software, transformer	212.33
VISMCT241P	Waterproof emergency fall detector for AmberSelect-X	65.57

AmberLink™

AmberLink is a low-cost Personal Emergency Response System (PERS) with the ability to communicate via a POTS or GSM connection.

- GSM or POTS communication
- Wireless environmental safety detection: smoke, flood, intrusion and CO
- Temperature monitoring
- Reports to a central station
- One-button emergency dialing
- Two-way speakerphone
- PC programmable

VISAMBERLINK	Advanced console with GSM350 cell option	161.12
VISAMBERLINKUSB	USB Programming Kit for AmberLink	45.90
VISGSM350	Internal GSM module for AmberLink	118.03
VISSIMCARDPACK	GSM Voice/Data card: AT&T, T-Mobile	20.61
VISMCT560	Temperature sensor for AmberLink	48.52



Visonic's Amber personal emergency response systems provide a complete solution for elderly people and others who need support to continue living independently in their homes.

Wireless Accessories for AmberSelect-X and AmberLink

VISMCT212P	Waterproof pendant	42.63
VISMCT220PERS	Large emergency button	32.14
VISMCT220SLEEVE	Rubber sleeve for the MCT220 button	1.31
VISMCT302PERS	Door/window/inactivity transmitter	33.36
VISK985MCW	Pet immune motion/inactivity transmitter	69.03
VISMCT550PERS	Wireless water/flood detector	44.85
VISMCT-426	Wireless smoke detector	64.26
VISMCT442PERS	Wireless carbon monoxide detector	78.69
VISREPEATERPACK	Wireless repeater, battery, transformer	117.04

	AmberLink	AmberSelect-X
Transmitters	28	3 Modes: 13/29, 29, 255
Cellular Capability	YES- internal option	NO
Fall Detector Use	NO	YES
Temperature Sensor	YES	NO
Voice Prompts	NO	YES
Inactivity Notification	3 - 72 hrs.	Unlimited
Two-Way Voice	YES	YES
Report to Private Phones	YES- 4	YES-4
Communication Format	Contact ID, 4x2, SIA	Contact ID
Reminder Capability	Yes - 4 (Tones)	Yes - 16 (Voice)

LogicMark

- Fully supervised one-button emergency dialing
- Two-way speakerphone from the pendant using DECT 2.4G technology
- Communicates with a central monitoring station
- Water resistant: the pendant can be worn in the shower
- Quick and easy voice prompted installation, no PC necessary
- A set of batteries is constantly on charge in the base
- Up to 4 pendants can be used with a base
- Three convenient carrying solutions are included with each system: Lanyard, Wrist/Wheelchair Strap holder and a Belt Clip

With LogicMark, the 2-way voice is in the keyfob

LifeSentry offers the ability to summon assistance at any time with the touch of a button. LifeSentry utilizes patented two-way voice communication right through the pendant for coverage in and around the home. The base station plugs into any standard telephone jack and can be programmed to contact any central station through Contact ID or 4 + 2 format.

The LifeSentry is ideal for dealers looking to increase their recurring monthly revenue. Simply program a primary and secondary number for the central station of your choice. The user will be able to communicate with the trained professional right through the pendant upon activation.



LOG37911	LifeSentry Product Kit Base Unit, Pendant Power Adaptor, Telephone Cord Belt Clip, Wrist Strap, Lanyard 2 Rechargeable Pendant Batteries 4 Rechargeable Base Batteries	178.71
LOG37920	Emergency Wall Communicator	64.95
LOG37915	LifeSentry Extra Pendant (with 2 batteries)	63.70
LOG37914	LifeSentry Base Station	129.71
LOG7006	Voice Synthesized Demo Pendant	10.00
LOG35917	Replacement Pendant Batteries	10.62



Population 65+ by Age: 1900-2050

Source: U.S. Bureau of the Census

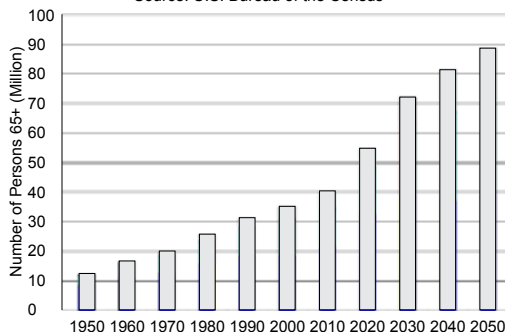

- There are 39.8 million Americans age 65 or over
 - By 2030 there will be 70 million
 - By 2050 over 100 million
- 4 of 10 individuals who reach 65 will reach 80
- An elderly person falls every 2 seconds
- What other industry can guarantee that the market will grow at this rate over the next 40 years?



What are you and your company doing to capitalize on this lucrative, fast growing market?

- "I have fallen and I can't get up," is a term the marketplace is already familiar with.
- From the commercials, customers identify with what a PERS does; capitalize on the marketing and offer a PERS solution with monitoring.
- Make certain you offer PERS with monitoring. Contact Fred at Automation Central (800-719-4537) for \$8/month wholesale monitoring.



PERS with Interactive and Environmental Sensors

PERS Wireless Sensors

			
LNDXS-64	LNDXS-62A	LNDXS-65	
			
LNDXS-31	LNDXS-80	LNDXS-54	LNDXS-73
LNDXS-31	Supervised Universal Door/Window	27.32	
LNDXS-54	Supervised PIR Motion Detector	61.47	
LNDXS-LRC	Supervised 1-Button, 1-Ch Pendant/Wrist	31.59	
LNDXS-64	Supervised 1-Button, 1-Channel Pendant	27.32	
LNDXS-65	Supervised Emergency Alarm Transmitter	30.78	
LNDXS-73	Supervised Photoelectric Smoke Detector	83.77	
LNDXS-80	Supervised Carbon Monoxide Detector	83.13	

Long Range PERS Wireless Sensors

		
LNDXS-LRP	LNDXS-LRC	LNDXS-LRW
LNDXS-LRC	Supervised Long Range Convertible Transmitter	31.59
LNDXS-LRP	Supervised Long Range Pendant	31.59
LNDXS-LRW	Supervised Long Range Watch	31.59

PERS Accessories

LNPWB-1	Petite Wristband for the DXS-62A	1.12
LNRJ-ADAPT	RJ-31X Telephone Adapter	4.13
LNRSM-1	Remote Speaker/Mic (4 conductor)	30.65
LNRWB-1	Replacement Wristband for the DXS-62A	1.12
DSCBD1.2-12	Replacement 12VDC 1.2aH Battery	8.56

PERS-2400

LNPERS-KIT-3B	PERS-2400B Kit: Includes LNPERS-2400B, 12V 1.2aH Battery, LNVB-4B 2-way Voice Interface, LNDXS-62A 1-Button Transmitter, Telephone Cord	164.07
LNVB-4B	2-way Audio Module w/ Voice Prompts	34.24
LNPERS-2400B	PERS system - Base Only	102.09



LNPERS-2400B

- Two-way voice option with the LNVB-4B board
- Speakerphone capability with the 2-way voice board
- Selectable inactivity reporting: 8, 12, or 24 hours
- Phone line seizure capability
- Capacity for up to 16 DX/DXS transmitters
- Point ID central station communicator reporting
- Programmable with Windows Software

PERS-4200

LN4200-KIT	LNPERS-4200 Kit: Includes LNPERS-4200, 12V 1.2aH Battery, LNVB-4B 2-way Voice Interface, LNDXS-LRC Supervised 1-Button, 1-Channel Pendant Transmitter, Telephone Cord	193.35
------------	---	--------

Kit comes tested and pre-programmed!



LNPERS-4200

- Two-way voice capability
- Speakerphone capability
- Reminder message capability with real time clock
- Selectable inactivity reporting: 8, 12, or 24 hours
- Phone line seizure capability
- Capacity for up to 16 DX/DXS transmitters
- Activity timer
- Reminder messages
- Point ID central station communicator reporting
- Programmable with Windows Software

AlertLink Nurse Call Pull Cord Interface

LNAL-1	Alert Link Nurse Call Pull Cord Interface	39.54
--------	---	-------



LNAL-1

- Add wireless pendant to most Nurse Call systems
- Four relay outputs with a fail-safe power wiring option
- Outputs are Latching or Momentary
- Trouble Contacts
- Accepts up to 32 DX Transmitters
- Includes Power Supply



Fully Integrated Security

2GIG is revolutionizing the security industry by integrating GSM communication (no phone line needed), wireless security, Z-Wave automation, 2-way voice, and a high resolution touchscreen in a single package.



Pages 87-90



Alexor

Introducing a 2-way wireless security suite from DSC. Because it operates completely wirelessly, installers have fewer holes to drill and fewer wires to pull. The system takes far less time to install than traditional wired or hybrid systems.



Pages 91-94



Door Strikes

There are two types of locking methods. "Fail-secure" means that the lock will continue to hold when power is lost, providing a secure perimeter. "Fail-safe" means that a lock will release when power is lost to allow easy exit in case of emergency.



Page 107



Gate Access Control

For some residential areas, extra security is desired. Gates provide this extra security but control is needed to operate the system. Gate control allows you to determine who is trying to enter the premises and whether to let them in or not.



Page 105



Security Devices

There is a security device for almost any application. Magnetic contacts protect doors and windows, motion detectors

monitor areas where no one should be, smoke detectors help with life safety, and glass breaks add further protection to doors and windows. These are just a few examples. For a complete security system, a combination of all of these devices works best.



Wireless

Wireless devices are available from almost every manufacturer that makes a security system. While not as reliable as hardwired, wireless allows you to complete installations where a security zone was not designed to be. Wireless is the preferred choice for retrofit applications as well. DSC offers their Alexor system which is completely wireless, including the keypads and sirens, which are a limitation of traditional wireless.



Wireless Locks

Wireless locks from Kwikset are available for use with 2GIG Go Control Panels as well as the Concord4 and Simon XT from Interlogix (additional modules required). When a code is entered on the pinpad, the door will unlock and a signal can be sent to the security panel to disarm the system. No more having to enter codes twice or worry about running out of time to disarm due to fumbling with keys.



Fire Supervision

For residential, the most common types of fire supervision are smoke detectors. Heat detectors and carbon monoxide detectors are also desired in some installations. Whether you are doing smoke-only or a full blown fire system, you must be sure to follow all local, state and national codes. Doing so will not only protect the homeowners, but it will protect you and your company as well. Life safety is the most important part of monitoring a home.

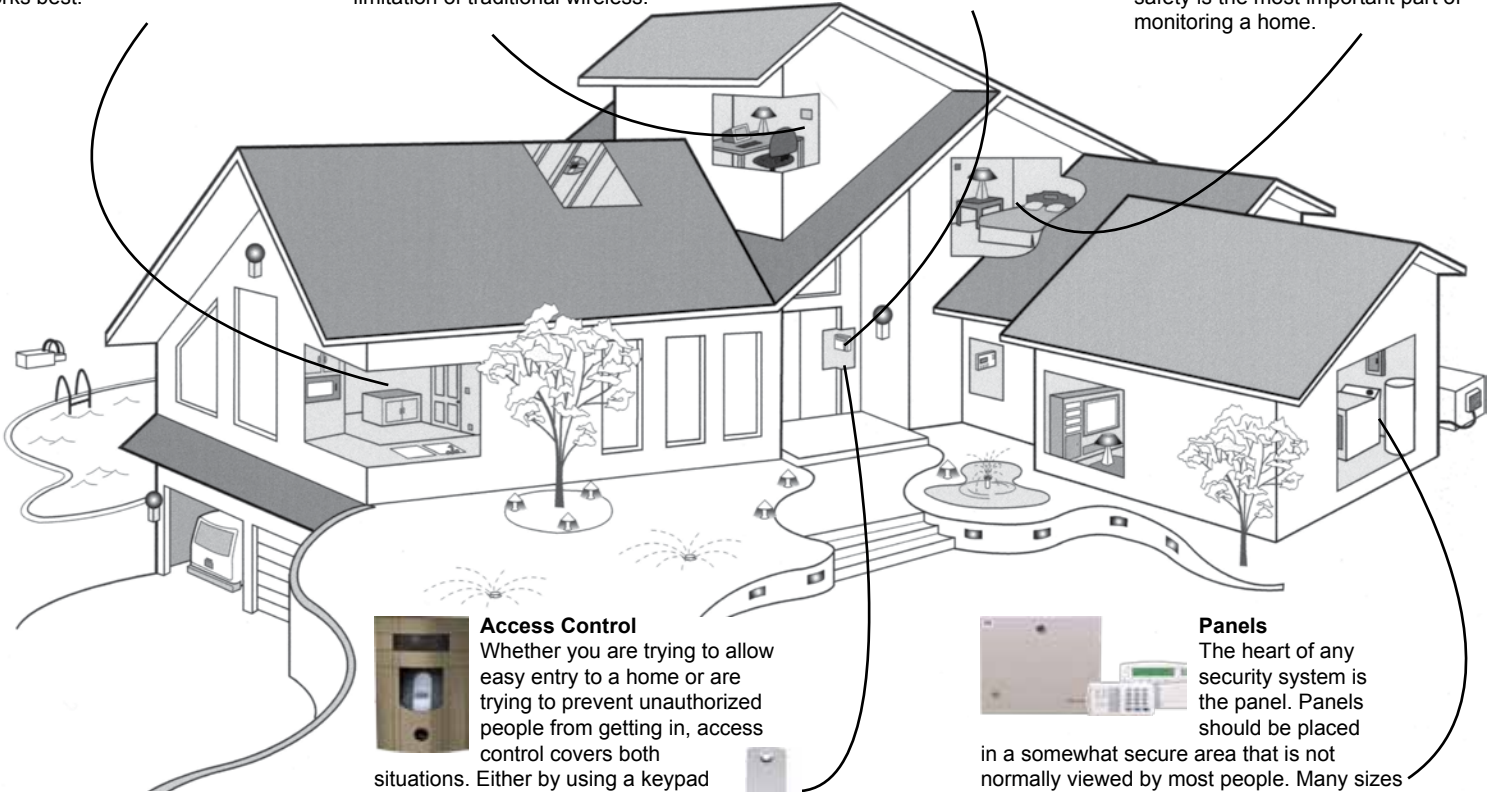

Access Control

Whether you are trying to allow easy entry to a home or are trying to prevent unauthorized people from getting in, access control covers both situations. Either by using a keypad or a biometric reader, you limit who has access. Some systems integrate cameras to be able to view who is at the door and most systems allow for many user codes. In some cases, levels of access are available.



Panels

The heart of any security system is the panel. Panels should be placed in a somewhat secure area that is not normally viewed by most people. Many sizes and types are available to fit almost any application. Choosing the proper size panel for the installation is an essential component of a security system. Too many zones and the system is overly complicated; too few zones could mean a weak system.

Updated 2GIG Go! Controller



- Color Touchscreen Display
- Fully Self-Contained
- Snap-in GSM Radio
- Updated Z-Wave Home Control
- Remotely Control Panel Settings
- Two-way Voice Over Cellular
- Over-the-air Update Functionality
- Customer Messaging Capable
- 48 Wireless Zones
- 2 Hardwire Zones
- Weather Information Display*
- 24-hour Backup Battery
- 32 User Codes
- Quick Arm/Exit

Wireless Security, Z-Wave Automation, GSM Wireless Connectivity and a Touchscreen in an All-In-One System

* Weather information display provided by the Alarm.com service

2GIG Controller Only

2GIG-CP21-345E	GO! Control Panel touchscreen with 2-way voice, wireless receiver, Z-Wave transceiver, battery backup, <u>GSM ready</u>	165.95
2GIG-CP-DESK	Desk/Table stand for the Go! Touchscreen	8.74

Optional Internal GE Receiver

2GIG-DREC2-319	Replacement GE / 2GIG / Honeywell 5800 wireless receiver. Not compatible with the TS-1 touchscreen, the image sensor, or GE life safety devices	56.20
----------------	---	-------

TS-1 Wireless Touchscreen



2GIG-TS1

- Easy access to all security and home automation features
- Extends system status, alerts and chime annunciation throughout the home
- Install on the wall or place on your night stand or countertop using the desktop kit
- Display and buttons completely darken at night and instantly illuminate with a single touch
- Add up to four TS1s per system

2GIG-TS1-E	2-Way Wireless Touchscreen	21.23
2GIG-XCVR2-345	900 MHz Transceiver for use with the TS-1	21.23
2GIG-TS1-DESK	Desk/Table stand for the TS-1 Touchscreen	8.12

Note: The TS-1 requires a Go! Control panel with the XCVR2-345 900 MHz Transceiver and system firmware 1.8 or later. Only one 900 MHz Transceiver is required for each Go! Control panel providing support for up to four TS-1s.

2GIG Z-Wave Thermostat



- Touchscreen interface
- Use with single/multi-stage systems and heatpumps
- Runs for 2 years on 4 AA batteries, no common required
- Simple scheduling provided via the Alarm.com interface
- The CT-100 has improved Z-Wave range versus the CT-30
- Ultra slim form factor

2GIG-Z-CT100	Z-Wave enabled multi-stage thermostat	78.06
RESRE205	Below 40° or above 100° temp sensor	24.98

Image Sensor



- Pet immune wireless motion detector with color camera
- IR illuminated black and white night vision
- Send e-mails or MMS alerts with images attached
- Requires Firmware 1.10 or higher
- Requires a XCVR2 900MHz transceiver
- Requires an Alarm.com account with an Image Sensor Plan

2GIG-IMAGE1	Wireless Motion Detector Image Sensor	93.68
-------------	---------------------------------------	-------

2GIG Controller Kits - Add Cellular Separately



2GIG-GCKIT311	(1) 2GIG-CNTRL2, (3) 2GIG-DW10, (1) 2GIG-PIR1, (1) 2GIG-KEY2	256.45
---------------	--	--------



2GIG-GCKIT410	(1) 2GIG-CNTRL2, (4) 2GIG-DW10, (1) 2GIG-PIR1	266.80
---------------	---	--------

Cellular Interfaces for 2GIG



2GIG-GC3GA-A	AT&T GSM 3G Module with ANT3X antenna	106.16
2GIG-GCCDMV-A	Verizon CDMA Module with ANT3X antenna	89.93

Z-Wave Access Control Deadbolt and Lever Sets

What better way to enhance your installations than to provide access control from the 2GIG touchscreen or Alarm.com? Customers can change the lock code over the web and the lock pin pad can even be used to disarm the 2GIG.



For a complete selection of 2GIG compatible Z-Wave locks see pages 10 -11

Note: Kwikset and Baldwin Z-Wave lock control was added in 1.6 firmware. Yale and Schlage support was added in 1.9 firmware. Schlage Motorized deadbolt support is added in 1.10 firmware

2GIG iPad/iPhone Emulator



- Looking to sell 2GIG from your iPhone or iPad?
- On your Apple device browse to 2GIG.com
 - Under Dealer Materials choose Dealer Site
 - You will need a login. If you do not have one, apply for one.
 - In the Dealer Site on the left look under Marketing for "Go! Control Demo App"
 - Follow the instructions for loading the app

Wireless Devices

2GIG-DW10	Thin Door/Window Contact with external input	21.23
2GIG-DW20R	Recessed Door Contact	26.85
2GIG-GB1	Glass Break Detector	46.21
2GIG-KEY2	4-Button Key Ring Remote	19.98
2GIG-GDR1	Garage Door Interface	28.73
2GIG-DBELL1-345	Wireless Doorbell	26.85
2GIG-PAD1	Wireless Keypad	39.97
2GIG-PANIC1	Panic Button Remote	27.48
2GIG-PIR1	Passive Infrared Motion Detector	49.96
2GIG-SMKT3	Smoke, Heat and Freeze Detector	61.20
2GIG-CO3	Wireless Carbon Monoxide Detector	73.69



2GIG-DW10: Door/Window

- External contact input
- Sensor Dimensions: 2.59 x 1.03 x 0.49 in.
- Supervised & tamper protected
- 5 year Lithium batteries



2GIG-DBELL: Doorbell

- Select from 11 chimes
- Sensor Dimensions: 2.75 x 1.17 x 0.63 in.
- Supervised
- Can trigger lighting



2GIG-DW20R: Recessed

- 2 1/2 in. long
- Fully supervised
- 5-year Lithium battery
- 0.625 in. minimum gap



2GIG-CO3: CO Detector

- Carbon Monoxide detector
- Wireless range is 300 feet
- 85dB sounder is built in
- Lithium battery
- Supervised tamper



2GIG-PANIC1: 1-Button Panic Button

- Triggers a panic alarm with 5-second lockout
- Completely water resistant
- Mounting options: Lanyard, wristband, wall mount, belt clip, car-visor clip
- Lithium battery with 3-year life



2GIG-PIR1: Motion Detector

- Dual element sensor: 30x50 ft. range
- 33 or 55 lb. pet immunity
- 90-degree look-down & 110° spread
- Lithium battery with 5-year life
- Fully supervised & tamper protected



2GIG-GB1: Glassbreak

- Monitors 360° for breaking glass sounds
- Two test LEDs
- Dual shatter recognition technology
- Lithium batteries with 5-year life
- Tamper protected, fully supervised

Wireless range on 2GIG sensors is 350+ feet

2GIG Takeover Solutions



- 2GIG-TAKE: Takeover Module**
- Converts hardwire zones to wireless
 - Converts 8 zones per module (additional modules may be added)
 - Easily connects to existing control panel's battery
 - Provides power backup through existing panel

2GIG-TAKE	8-Channel takeover transmitter. Converts 8 hard-wired loops to 2GIG wireless zones	47.46
-----------	--	-------

Recommended Power Solutions for the 2GIG-TAKE

ALTAL624E	1.2A, 12VDC power supply in an enclosure	31.85
ELKTRG1640	16.5v 40vA transformer	14.14
UB1250	12VDC 5aH battery	11.01



- 2GIG-SMKT3: Smoke Detector**
- Supervised Photoelectric smoke detector
 - Built-in 85 dBA sounder
 - Separately detects smoke, heat and freeze



- 2GIG-PAD1: Wireless Keypad**
- Arm and Disarm system
 - Fire and Panic emergency functions
 - Lithium coin batteries, 5 year life



- 2GIG-KEY2: Keyfob**
- Arm and Disarm system
 - Auxiliary output and emergency functions
 - Garage Door Control with GDR1 Interface
 - 5-year Lithium coin battery



- 2GIG-GDR1: Garage Door Interface**
- Control Garage Openers operated by contact closure
 - Supports up to 10 Key2 keyfobs*
 - Self-contained power
 - Over 1 million secure codes



2GIG-KEY2	4-Button Key Ring Remote	19.98
2GIG-GDR1*	Garage Door Interface	28.73

*GDR1 allows garage control with the star key on a Key2 remote

2GIG Accessories



2GIG-GC-POTS

2GIG-GC-POTS	POTS Module for the new 2GIG-CP21-345E. Second generation Go! Controller	11.24
2GIG-UPCBL2	Firmware update cable for the TS1 and Go!	23.11
2GIG-ANT2X	Optional External GSM Attic Antenna, 10 ft	28.73
2GIG-ANT3X	Replacement External In-wall Antenna	7.49
2GIG-AC1	Replacement plug-in power supply	11.24
2GIG-BATT1	Replacement Standard Battery Pack, 4hr	13.74
2GIG-BATT1X	Optional Extended Battery Pack, 24hr	18.74



2GIG-DEMOKIT Demo kit with CNTRL2, Z-CT100, KEY2 and a DW10 299.00

Recommended Additions for a GREAT 2GIG demo

2GIG-GCCDMV-A	Verizon CDMA Module with ANT3X antenna	89.93
2GIG-CAM-HD100	HD Indoor IP Camera with IR	134.89
JAS45602WB	Lamp Module, 300W Incandescent	31.54
BD99100-005*	Standard Motorized Deadbolt - Satin Nickel	168.62

* A discounted lock display is available, register for an account and order through <https://store.leehunterassociates.com>

Wireless Takeovers Have Never Been Easier



2GIG offers a great line of competitively priced wireless sensors; however, if the wireless is not 2GIG or Honeywell 5800 series look to Resolution Products. The translator products allow DSC, GE or Napco wireless products to work with 2GIG.

DSC or GE
Wireless



Translated
to 2GIG
Wireless



RESRE224DT	Translator, DSC Wireless to 2GIG Wireless	56.20
RESRE224GT	Translator, GE Wireless to 2GIG Wireless	56.20
RESRE224NH	Translator, Napco Wireless to 2GIG Wireless	56.20
RESRE012	12VDC Transformer for Repeaters/Translators	5.62

2GIG is compatible with Honeywell 5800 series wireless without a translator

Installing a 2GIG in a large home? You can extend the range of 2GIG wireless with a Resolution Products repeater.

RESRE220T	2GIG Wireless Repeater for 2GIG and Honeywell	64.95
RESRE012	12VDC Transformer for Repeaters/Translators	5.62

Z-Wave Controlled Water Valves



FRTWW01US075

- Professional grade, Z-Wave operated wireless water valve
- Motorized brass ball valve that can be commanded via Z-Wave to turn off the main water supply
- Comes in standard pipe sizes: 1/2", 3/4", 1", and 1 1/4"
- Certified to Z-wave v4.51
- Will qualify for insurance premium discounts for flood protection insurance. (Ask your insurance company for specific details)
- Two switches for manual operation

FRTWW01US075	3/4" motorized water valve, includes valve and wired water sensor.	370.02
FRTWW01LFUS075	Same as above, NSF61G certified lead free	421.23
FRTWW01US100	1" motorized water valve, includes valve and wired water sensor.	378.13
FRTWW01LFUS100	Same as above, NSF61G certified lead free	434.34

Water valves are also available in 1/2" and 1-1/4", call for pricing.

2GIG Compatible Z-Wave Sounder



FRTSSA-02

FRTSSA-02

- 117dB siren for auditory notification
- 5 LED's for visual notification
- LED's and siren can be controlled via standard lighting level commands

FRTSSA3US

- Outdoor rated
- Built-in tamper switch



FRTSSA3US

FRTSSA*US	Z-Wave Siren/strobe, 12VDC with 9V battery backup. Use with WWA-001 1 - Clear lens, 2 - Red lens	42.47
FRTSSA3US	High Output Outdoor Z-Wave Siren/strobe, 12VDC with 9V battery backup	68.88

Resolution Products Sensors for 2GIG

RESRE219	Home Disaster (Flood/Hi-Lo Temp) Sensor	41.22
RESRE204	Driveway Detector, C Size Battery	94.92
RESRE205	Below 40° or above 100° Temp Sensor	24.98
RESRE206	Tilt Sensor, great for garage doors	24.98
RESRE252T	Wireless Pinpad for 2GIG Controllers	41.22
RESRE116-U	Wireless Sounder with Transmitter	79.94
RESRE116	Wireless Sounder Receiver Only (use to add additional sounders to the transmitter)	67.45



RESRE252T

Wireless Pinpad

- A secure keyfob which requires a code for disarm
- Can be portable or installed with tape or screws
- 1-Button arming
- 4-6 year battery



RESRE116-U

Wireless Sounder

- Two piece sounder system compatible with 2GIG, GE Honeywell, DSC or any panel with siren terminals
- Siren can be set high or low and follows the siren pattern
- Built-in cover tamper
- Siren half plugs into an AC outlet and has battery backup



RESRE204

Vehicle Detector

- 15' radius
- Only detects metal moving
- 3-5 years on 2 C Batteries



RESRE205

Temp Alarm

- 3 loops: Below 40°, above 100°, and reed switch



RESRE219

Disaster Sensor

- Protects against low temperatures (under 40°)
- Remote Titanium Probe makes installation easy and resists corrosion
- Great for use with a FortrezZ Z-Wave controlled valve
- Can report temps over 100°

Concealed Wireless Ion Security Sensors

IONMICRA-2G	2GIG compatible wireless window sensor: less than 1/2" deep x 3/4" wide	24.98
IONPLUNGER-2G	2GIG compatible wireless door sensor: less than 1" deep x 3/4" wide	24.98
IONFDB75	3/4" Forstner drill bit for Ion Sensors	6.24
IONWG125	Extra strength magnet for 1.25" gaps	3.12



Installation Tip

For maximum range, keep the antenna straight using the provided plastic tube.

Ion Micra

Ion Plunger

Z-Wave Large Load Control



RCSPC30	Z-Wave Controlled 30 Amp Contactor 120/208/240 VAC	186.41
---------	--	--------

- Z-Wave load control
- Great for control of larger electrical loads such as Electric Water Heaters and Pool / Spa Pumps
- 2 - 120, 208, 240 Volt, 30 Amp Contactor Relays
- Local On / Off Control
- Nema-4X, 6P Enclosure

Add Cameras to the Alarm.com Interface

ALAADC-V520IR IR Illumination	ALAADC-V720 Outdoor Bullet	ALAADC-V820 Indoor Dome	2GIG-CAM-HD100 Indoor with IR
2GIG-CAM-HD100	HD Indoor IP Camera with IR		134.89
ALAADC-V620-PT	Indoor Pan/Tilt, Wireless IP Camera with PS		231.06
ALAADC-V520-IR	Indoor Wireless IR IP Camera with PS		158.62
ALAADC-V520	Indoor Wireless IP Camera with PS		138.64
ALAADC-V700X	Outdoor/Night Vision POE IP Camera		236.06
ALAADC-V720	Outdoor POE IR IP Camera with PS		236.06
ALAADC-V720W	Outdoor Wireless IR IP Camera with PS		306.00
ALAADC-VS820	Indoor IP Dome camera with PS		221.07
ALAADC-VS420	4-Channel Analog-to-IP Video Server		412.17
ALAADC-VS1	Analog-to-IP Video Server		149.88
ALAADC-POE	POE Injector for the ALADC-V700X		43.72
Alarm.com cameras only work in conjunction with the Alarm.com service			

Cellular Signal Booster

Wi-Ex zBoost cell signal boosters are perfect for GSM installations with weak signal strength inside the home. zBoost places an antenna outside to capture the signal and repeats the cell connection in the home. As an added benefit, it improves your customer's standard cell connections as well! zBoost models repeat 800 and 1900 MHz signals, so they work with all US carriers. Installation is simple. Just mount the outdoor antenna and run coax from the antenna to the indoor unit, mounted central to the structure. No programming or configuration is necessary.

NEW

WIXYXC3500	Cell booster for 3500 sq ft coverage	240.00
WIXYXC8000	Cell booster for 8000 sq ft coverage	385.00
WIXYX745	Cell booster for 12000 sq ft coverage	449.00

Z-Wave Beaming Command

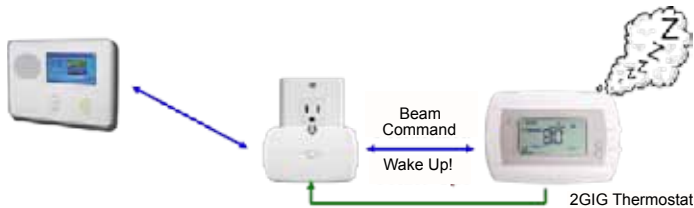

- Not all Z-Wave devices are the same. Newer devices support the Beam Command
- First generation Z-Wave battery devices could only transmit, they could not be polled
- Second generation Z-Wave devices like the 2GIG Thermostat and Z-Wave locks run on batteries and have 2-way communication
- For a 2GIG to increase Z-Wave communication distances to 2-way battery devices, they must communicate through modules that support the Beam Command
- A device that carries the Z-Wave logo may provide support for the Beam Command. The only way to ensure compatibility is to know the product you are installing.

2GIG Compatible Z-Wave Lighting: Jasco



GE Keypad

JASCO

- Jasco products support the latest Z-Wave commands, including beaming
- Jasco products are fully 2GIG compatible



Dimmer/Switch



Outdoor Plug-In Module



Tamper Resistant Receptacle

JAS45612***	Dimmer, 600W Incandescent, single pole or 3-way	33.72
JAS45609***	In-Wall Switch, 15A Resistive or 600W Inc.	31.22
JAS45610***	In-Wall 3-way Remote (use with 45612 or 45609)	11.55
JAS45705	15A Duplex Receptacle, one controlled outlet	31.16
JAS45631	Keypad Controller, wall mount, battery powered	36.22
JAS45602WB	Lamp Module, 300W Incandescent	31.54
JAS45603WB	15A Resistive Appliance Module	29.66
JAS45704	Outdoor Plug-In 15A Resistive Appliance Module	32.47

*** WB - White, LAB - Light Almond

Z-Wave Repeater Module



AEON LABS

- Full Beam Command
- 2GIG Compatible
- Only covers one outlet
- Great for expanding Z-Wave communication to locks and thermostats

AEODSD37-ZWUS	Plug-in Z-Wave repeater with beaming support, use to extend Z-Wave networks	29.10
---------------	---	-------

2GIG Z-Wave Lighting Modules: Linear

Linear

Dimmers and Switches

- Full Beam Command support
- Top On/Bottom Off, hold top/bottom for bright/dim



2GIG-PD300Z-2	Plug-in Lamp Module, 300W, dimmable	29.51
2GIG-PS15Z-2	Plug-in Appliance Module, 15A, relay	29.51
2GIG-WD500Z-1	Decorator single-pole 500W Dimmer with neutral	29.51
2GIG-WS15Z-1	Decorator single-pole Switch, 15A with neutral	29.51
LNWO15Z-1	Wall Outlet, 15A, one side controlled	29.51
LNFS20Z-1	Isolated contact Fixture Module, Contacts rating: 20A 277VAC, 1HP 120/240VAC, 960W Inc.	32.20
2GIG-WT00Z-1	Z-Wave Transmitter for 3-ways	29.51

* Wall dimmer and switch are white, color trim kits are available in Almond, Black, Brown and Ivory. Call for details.

DSC Impassa

IMPASSA is the newest, next generation wireless security system from DSC. IMPASSA comes with the defense and offense needed to protect the 'king' – the home and homeowner - including:

Built-in 2-way audio VOX and push-to-talk alarm communication, 2-way wireless support, supports 32 wireless zones and 16 wireless keys (without using a zone slot), 1 wirefree keypad, 2 input/output terminals, optional integrated cellular communicator, easy wireless device enrollment process, 500 event buffer, premium lighting, and account code error checking.

All kits include control/keypad, manuals, battery, RJ31X, and transformer

DSCKIT457-12	Impassa 12 kit with (1) WS4904P wireless pet immune motion detector, (1) WT4939 wireless keyfob, (3) WS4945 wireless door/window contacts	267.54
DSCKIT457-14	Impassa 14 kit with (1) WS4904P wireless pet immune motion detector, (1) WT4939 wireless keyfob, (3) EVDW4975 vanishing contacts	267.54
DSCKIT45792	Impassa 92 3G ready kit with (1) WS4904P wireless pet immune motion detector, (1) WT4939 wireless keyfob, (3) WS4955 wireless door/window contacts	298.11
DSCKIT457-96H	Impassa 96H with integrated HSPA (3G) communicator kit with (1) WS4904P wireless pet immune motion detector, (1) WT4939 wireless keyfob, (3) EVDW4975 vanishing contacts	420.41
DSCKIT457-99H	Impassa 99H with integrated HSPA (3G) communicator kit with (1) WS4904P wireless pet immune motion detector, (1) WT4939 wireless keyfob, (3) WS4945 door/window contacts	420.41
DSCTL2553G	Redundant IP and HSPA (3G) Wireless Alarm Communicator for the Impassa	TBD
DSC3G2055-USA	HSPA (3G) Wireless Alarm Communicator for the Impassa	183.45
DSCSCW9057DMK	Desk Stand for Impassa Control	16.05



IMPASSA Control

Two-Way Wireless Devices

These devices are only supported by the DSC two-way Alexor, Impassa and Powerseries 4.6 controls

DSCWT5500	Wire-free keypad	123.83
DSCWT5500D	Wire-free keypad with stand & transformer	140.65
DSCWT5500P	Wire-free keypad with proximity reader	146.76
DSCWT5500X	Transformer for WT5500 keypad	10.09
DSCWT4989	2-way wireless keyfob w/ icon display	41.28
DSCWT4901	Wireless indoor siren	55.03
DSCWT4911B	Wireless outdoor siren, blue lens	114.66
DSCWT4911R	Wireless outdoor siren, red lens	114.66



DSCWT4901



DSCWT4989



DSCWT5500

DSC Alexor Kits

The Power of Speed with Wireless Installation. Less Install Time + More Installs = More Revenue

Both DSC wireless panels can be the center component of DSC's 2-way wireless security suite. Because it operates completely wirelessly, installers have fewer holes to drill and fewer wires to pull. The system – with its full complement of exclusively compatible wireless accessories, detectors and keypads – takes far less time to install than traditional wired or hybrid systems. Supports 32 wireless zones and 16 wireless keys (without using a zone slot).

Alexor is a wireless control panel, the virtual "brain" of the security suite. Because it is a distributed system, the panel is not attached to the keypad physically, but rather wirelessly. Designed for flexible, secure installation locations within the home, as long as there is access to AC power. The Alexor can communicate by phone, or with optional IP, GSM, or fully IP/GSM redundant communicators.

All kits below include the following parts: Alexor distributed wireless control, a 12v 2.3A lead acid battery, a PTD1620U-CC Class 4 high efficiency transformer, telephone jack and cord, and English user and installer manuals.



ALEXOR

DSCKIT49518CP01	Kit 18, Controller, battery, transformer, phone cord, and manuals	206.38
DSCKIT49512CP01	Kit 211: (1) WT5500 wire-free LCD keypad, (1) WS4904P wireless pet immune motion detector, (1) WS4939 wireless keyfob, (2) WS4945 wireless door/window contacts	304.23
DSCKIT4951CP01	Kit 311, (1) WT5500 wire-free LCD keypad, (1) WS4904P wireless pet immune motion detector, (1) WT4989 wireless keyfob with ICON display, (3) WS4945 wireless door/window contacts	343.97
DSCKIT49516CP01	Kit 16, (1) WT5500 wire-free LCD keypad, (1) WS4904P wireless pet immune motion detector, (1) WT4989 wireless keyfob with ICON display, (3) EVDW4975 wireless door/window contacts	343.97
DSCKIT49517CP01	Kit 17, (1) WT5500 wire-free LCD keypad, (1) WS4904P wireless pet immune motion detector, (1) WS4939 wireless keyfob, (3) EVDW4975 vanishing contacts, (1) WT4901 wireless siren	334.81
DSCKIT49517GCP1	Kit 17 with GSM (1) WT5500 wire-free LCD keypad, (1) WS4904P wireless pet immune motion detector, (1) WS4939 wireless keyfob, (3) EVDW4975 vanishing contacts, (1) WT4901 wireless siren	457.11
DSCKIT49515DCP0	Kit 311 w/ GSM & IP, (1) WT5500 wire-free LCD keypad, (1) WS4904P wireless pet immune motion detector, (1) WT4989 wireless keyfob with ICON display, (3) WS4945 wireless door/window contacts, (1) TL265GS dual path communicator	565.65
DSCKIT4951GCP01	Kit 311 w/ GSM, (1) WT5500 wire-free LCD keypad, (1) WS4904P wireless pet immune motion detector, (1) WT4989 wireless keyfob with ICON display, (3) WS4945 wireless door/window contacts, (1) GS2065 GSM/GPRS communicator	519.78
DSCTL265-NA	IP communicator for Alexor	107.01
DSCTL265GS-USA	Dual path communicator IP & GSM for the Alexor	233.90

Don't forget to check www.worthingtonu.com for updated trainings and dates for classroom trainings

PowerSeries Residential Control Kits

Today's PowerSeries product family not only protects people, premises and possessions, but also provides unprecedented levels of convenience, comfort and control. DSC makes it easy for you to stay ahead of the technology curve with the easiest to sell, easiest to install and easiest to use security systems anywhere. There are 3 basic sizes available: 6 to 16 zone, 8 to 32 zone, and 8 to 64 zone capability.



DSCKIT3251NT



All kits below are in enclosure and include battery, RJ31X, and indoor siren. Transformer is sold separately.

DSCKIT16120NT	PC1616SNK in enclosure, RFK5501 keypad w/ wireless receiver, LC100PI motion	128.42
DSCKIT16QP63CP0	3-1-1 Kit: PC1616SNK in enclosure, RFK5501 keypad w/ wireless receiver, (3) WS4945 contacts, WLS4904-433 Motion, and WS4939 keyfob	313.32
DSCKIT3251NT	PC1832NK panel in enclosure, PK5500 full-message keypad	196.29
DSCKIT32POWER5N	PC1832NK panel in enclosure, PK5501 picture icon keypad, LC100PI motion	139.80
DSCKIT32-16CP01	PC1832 panel in enclosure, RFK5501 keypad with wireless receiver, LC100PI motion	119.02
DSCKIT32219NT	PC1832 panel in enclosure, RFK5500 keypad with wireless receiver, LC100PI motion	224.35
ELKTRG1640	Transformer (not included in above) 16.5 VAC, 40VA, auto reset with LED	14.14

PowerSeries Keypads

DSCPK5500	64-zone LCD full message keypad, input/output terminal, FAP keys, full 32-character phrases	112.04
DSCPK5501	64-zone LCD picture icon keypad, input/output terminal, Fire, Ambulance, Police keys	56.63
DSCRFK5500	Same as DSCPK5500, with integrated 32 zone RF repeater	139.11
DSCRFK5501	Same as DSCPK5501, with integrated 32 zone RF repeater	78.70
DSCRFK5564	Same as DSCPK5500, with integrated 64 zone RF repeater for PC1864 V4.6 or later	139.11



DSCPK5500



DSCPTK5507

PowerSeries TouchScreen Security Interface

7" full color display, 800x480 resolution, slim modern design, intuitive LED indication of security system status, picture frame feature, clock feature, intuitive user interface, customizable home screen, customizable wallpaper, menu user programming, installer programming, virtual keypad, SD card, photos, compatible with PC1864, PC1832, PC1616 control panels, approvals: IC, FCC.

DSCPTK5507	7" LCD Touchscreen for Powerseries controls, customizable and intuitive	220.15
------------	---	--------

PowerSeries Modules

DSCPC5108	8-hardwire zone expander; adds 8 zones and 125 mA aux power	35.30
DSCPC5100	Addressable zone expander; adds up to 32 addressable devices	32.24
DSCPC5200	Power supply module; 1 Amp	50.81
DSCPC5204	Power supply module; adds 4 programmable high-current outlets, rated at 1 Amp	69.47
DSCPC5208	Output module; adds 8 programmable low-current outputs	31.54
DSCESCORT5580TC	Telephone Interface, turns any touch tone phone into a talking keypad	81.35
DSCIT100	Data interface module; supports bi-directional RS232 commands for third party interface, use for HAI Lumina integration	50.96



DSCIT100



DSCPC5108

C24 Interactive Connectivity

C24 Interactive is the ideal dealer platform to extend current service capabilities, both within and beyond the existing customer base. With C24 Interactive, innovative, easy-to-use security devices not only protect your customers while building loyalty and brand recognition, they ensure revenue growth in the ever-changing technology market. And with C24 Interactive's modular approach to home automation, dealers can up-sell and offer upgrade devices year after year.

DSCIT230	RS-422 interface module for C24 Interactive Gateway, Powerseries V4.5 or later	61.15
DSCC24-HUB	C24 Interactive Ethernet gateway	200.06
DSCC24-CAM54IR	C24 Interactive IP54 rated indoor/outdoor IR illuminated camera	180.58
DSCC24-CAMANL	C24 interactive analog camera adapter	136.38
DSCTZ45D	Z-wave Thermostat	145.23

Approved Z-Wave Modules

JAS45633	Inclusion - Lighting Control Advanced Remote	45.09
JAS45602WB	Plug-in Dimming Lamp Module	31.54
JAS45603WB	Plug-in On/Off Indoor Appliance Module	29.66
JAS45604	Plug-in On/Off Outdoor Appliance Module	36.16
JAS45609WB	In-Wall On/Off Switch	31.22
JAS45612WB	In-Wall Dimming Switch, with Neutral	33.72

Yale
real Living

JASCO

Kwikset SMARTCODE

RCS



Programming

DSCPCLINK-SCW	Direct connect DB-9 cable	13.76
DSCMD-12NTNA	Serial modem for remote panel communications, transformer is not included	88.79

All programming software packages can be downloaded from the manufacturer's website after registration: www.dsc.com

PowerSeries Modules and Communicators

DSCTL300	T-Link Universal IP Alarm Communicator; compatible with ANY alarm panel that uses Contact ID format, reports to 2 different IP addresses, 4 programmable inputs. Reports to Central Station with Sur-Gard IP receiver.	191.10
DSCTL300CF	Commercial Fire Approved T-Link Universal IP Alarm Communicator; compatible with ANY alarm panel that uses Contact ID format, reports to 2 different IP addresses, 4 programmable inputs. Reports to Central Station with Sur-Gard IP receiver.	393.41
DSCTLINKTL250	T-Link Internet Alarm Communicator; supports PowerSeries and Maxsys control panels, supports DHCP, download control panel programming over the internet, reports to 2 different IP addresses with Sur-Gard IP receiver	159.25
DSCTL260R-NA	T-Link Internet/Intranet Alarm Communicator; supports PowerSeries V4.1 or higher control panels, remote uploading and downloading, interface for C24 hub	107.01
DSC3G2060R-USA	HSPA (3G) Cellular Alarm Communicator for PowerSeries controls, supports PowerSeries V4.1 or higher control panels, remote uploading and downloading, interface for C24 hub	183.45
DSCTL2603GR-USA	Fully redundant Internet and HSPA dual-path alarm communicator, supports PowerSeries V4.1 or higher control panels, remote uploading and downloading, interface for C24 hub	233.90
DSC3G3070USA	HSPA Universal Cellular Alarm Communicator, works on ANY control panel using Contact ID via CONNECT24™ to a Central Station Sur-Gard IP receiver	191.10
DSC3G3070CF-USA	Commercial Fire Approved HSPA Fire Alarm communicator. Approved for commercial fire applications, works on ANY control panel using Contact ID	313.40
DSC3G3070-UPG	HSPA (3G) Upgrade Kit for GS3055(-ICF)/GS3060 (Universal)	127.40



DSC3G3070USA



DSCTL2603R



DSC3G3070CF



DSCTL300



DSCTL260R



DSCTR5164433



DSCTLINK250



DSCRXL2433

PowerSeries Wireless Receivers

DSCTR5164433	Wireless two-way receiver for PowerSeries control, supports 64 wireless zones and 16 wireless keys, ver 4.6 or later	84.08
DSCRF5132-433	Wireless receiver for PowerSeries control, supports 32 wireless zones and 16 wireless keys	56.29
DSCRF5108433	Low-cost alternative when only a few zones are needed. Supports 8 detectors, 8 wireless keys, and 2 wireless outputs.	52.18
DSCWS4920	Wireless repeater to extend coverage of wireless devices	99.37
DSCPC5320	Connect up to 4 wireless receivers for increased coverage, for PowerSeries	52.56
DSCRXL2433	Universal wireless relay module, 2 on-board relays, can be independent of security system for access and light control	42.80

DSC PowerSeries panels with firmware of 4.6, and with 64-zone receivers, can now support wire-free keypads and other 2-way wireless devices (not sirens). See next page for other 2-way devices. If you need a wireless siren, please call Worthington technical support for assistance.

Wireless Devices for all versions of DSC Controls



DSCWS4916



DSCWS4965



DSCWS4904P



DSCWS4985



DSCEVDW4917



DSCEVDW4975



DSCWLS912L433



DSCWS4969

DSCWS4913	Wireless carbon monoxide detector	75.68	DSCWS4916	Wireless smoke/heat	60.20
DSCWS4904P	Wireless PIR (85 lb pet-immune)	63.70	DSCWLS912L433	Wireless glassbreak	79.74
DSCWS4965	Tri-Zone wireless door/window contact	35.08	DSCEVDW4927SS	Wireless shock sensor with contact	37.27
DSCEVDW4917	Wireless recessed door transmitter	32.49	DSCWS4938	1-button personal panic	35.87
DSCEVDW4975	Vanishing wireless door contact	26.24	DSCWS4949	2-button wireless keyfob	23.39
DSCWS4945	Wireless door/window contact N/C	26.24	DSCWS4939	4-button wireless keyfob	30.96
DSCWS4945N	Wireless door/window contact N/O	31.34	DSCWS4969	4-button wireless keyfob with flashlight	33.22
DSCWS4985	Wireless flood detector	45.86	DSCWS4959	12-button wireless keyfob	32.20

DSC compatible wireless devices manufactured by other vendors can be found on page 99



Hardwired Photoelectric Smoke Detectors



FSA Series Smokes

TECHNICAL NOTE:

The proper installation of a 4-wire smoke detector system includes an end-of-line relay to supervise the power lines of the smokes. If you use smokes with sounders, you also need a polarity-reversing relay to cause all sounders to trigger when the alarm occurs.

DSCFSA210B	2-wire, basic smoke	24.14
DSCFSA210BT	2-wire with heat sensor	27.32
DSCFSA210BST	2-wire w/ heat sensor and 85 dB sounder	26.69
DSCFSA410B	4-wire, basic smoke	27.95
DSCFSA410BT	4-wire with heat sensor	27.95
DSCFSA410BS	4-wire with 85 dB sounder	30.76
DSCFSA410BST	4-wire w/ heat sensor and 85 dB sounder	26.69

Fire Alarm Necessities

DSCPRM2W	Polarity reversal module, for use with 2-wire smoke detectors, will convert 2-wire smokes to 4-wire, need 1 per zone	23.39
DSCPRM2WC	Polarity reversal module, same as above, in plastic case	28.54
DSCPRM4W	Polarity reversal module, for use with 4-wire smoke detectors	19.50
DSCPRM4WC	Polarity reversal module, same as above, in plastic case	28.54
DSCRM2	EOL power supervisory relay, 4-wire smoke circuit supervision	15.29
DSCFSD100	Hand-held smoke detector tester	117.21



DSCPRM4W



DSCFSD100

DSC Motion Detectors

DSCLC120PI	Digital PIR detector with 55 lb. pet immunity	21.91
DSCBV500	Ceiling-mount 360 degree PIR	27.58
DSCBV501GB	Ceiling-mount 360 degree PIR with built-in glassbreak	54.73
DSCBV600	Dual-element, pet-immune PIR	25.60
DSCLC100PI6P	Quad linear technology, pet-immune	8.69
DSCLC103PIMSK	Dual tech, PIR/microwave, pet-immune 55 lb, anti-masking	58.60
DSCLC104PIMWW	Dual tech, PIR/microwave, pet-immune 55 lb, quad linear technology	44.34
DSCLC151	Outdoor dual tech PIR/microwave with adjustable pet immunity	76.44
DSCLC171	Outdoor dual tech double PIR/microwave with adjustable pet immunity	119.24



DSCBV500



DSCLC151



DSCLC100PI6P



DSCLC103PIMSK



DSCBV600



DSCLC171

Sirens

DSCSD15W	15W Dual Tone Surface Mount Siren, 12VDC	3.82
DSCSD30W	30W Dual Tone Surface Mount Siren, 12VDC	7.64



DSC Glass Breakage Devices



DSCAC500



DSCAC100



DSCAFT100

DSCAC100	Wall-mount, up to 25', jumper-selected sensitivity	26.75
DSCAC500	Ceiling-mount - up to 25' away	29.30
DSCAFT100	Glassbreak simulator; the accurate way to test your glassbreaks	83.38

Sirens and Low Current Sounders



Piezo Sirens

ATWSGST-W	Piezo siren, single-gang flush, indoor, 105dB, 20mA	8.74
ATWBULLDOG	Piezo siren, surface-mount, indoor/outdoor, 105dB, 110mA	8.99
ATWBLOODHOUND	Piezo siren, 1-gang box mount, indoor/outdoor, 104dB, 90mA	8.99
ATWDOBERMANPLUS	Piezo siren with strobe, surface-mount, outdoor, 104dB, 180mA	17.36
ATWPC-300	Multi-tone piezo chime, single-gang, flush, 3-tone, 80 dB	15.36



ATWBULLDOG



ATWSGST

Sirens (built-in driver)

ATWDS-50	5" dual tone 15W Siren	6.00
ATWDS-406	4" x 6" dual tone 25W Siren	11.74
ATWDS-301SET	Siren in stainless steel enclosure with tampers, 25W	33.41



ATWDOBERMANPLUS

8 Ohm Siren Speakers (driver separate)

ATWFK-56	Flush-mount 15W speaker	6.87
ATWH-508	Speaker horn, 30W peak	11.49
ATWH-301SET	Speaker in stainless steel enclosure with tampers, 25W	36.08
ATWSTL-1*	Strobe for DS-301SET or H-301SET (*amber, blue, clear, red)	9.74



**ATWDS-301SET
ATWH-301SET
with optional strobe**

Simon XTi System

Faster Installs, Higher Reoccurring Revenue, and Less Attrition

The next-generation Simon XTi enhances the longstanding reliability and performance of the Simon XT™ with the advanced technology of the Two-Way Talking Touchscreen. This self-contained security system offers exclusive image capture technology, combined with powerful security and color LCD touchscreen convenience, for a cost-effective, easy-to-use solution. The Simon XTi panel comes standard with 40 wireless zones, or it can be set up with 38 wireless zones and two built-in hardwired supervised burglary zones (normally-closed loop only). The built-in radio receiver works with both crystal and SAW LearnMode™ sensors. Like Simon XT, the Simon XTi is more than a security system. It can also be used to control lights, door locks and thermostats.* Alarm.com services are also available for the Simon XTi. (*Requires Z-Wave-enabled modem)



SIMON XTi

IT1806323NXTI	Simon XTi starter package. Includes: Control, Battery, Class II Transformer, Phone Cord, RJ31X Jack.	220.14
IT160924RFTS	Wireless 2-way Talking Touchscreen for Simon XT™	109.60
IT1805173NXTI	Simon XTi 3/1/1 SAW package. Includes: (3) IT16067095R Contacts, (1) IT16080795R PIR, (1) IT1600106495R Micro Keyfob, Control, Battery, Class II Transformer, Phone Cord, RJ31X Jack	320.37
IT1806493NXTI	Simon XTi 3/1/1 Crystal package. Includes: (3) 60362N103195 Contacts, (1) IT16080795R PIR, (1) IT1600106495R Micro Keyfob, Control, Battery, Class II Transformer, Phone Cord, RJ31X Jack.	326.93
IT1806493DXTITM	Simon XTi 3/1/1 Crystal package (above) with Z-Wave and GSM for T-Mobile (806493DXTIGSMTM)	414.04
IT1806493DXTIAT	Simon XTi 3/1/1 Crystal package (above) with Z-Wave and GSM for AT&T (806493DXTIGSMAT)	410.30
Coming Soon	Simon XTi 3/1/1 Crystal package (above) with Z-Wave and CDMA for Verizon	TBD
IT1806493NXTITM	Simon XTi 3/1/1 Crystal package, with Z-Wave, GSM for T-Mobile, plus 2-way Talking Touchscreen(806493NXTIGSMTM)	453.39
IT1806493NXTIAT	Simon XTi 3/1/1 Crystal package, with Z-Wave, GSM for AT&T, plus 2-way Talking Touchscreen (806493NXTIGSMAT)	449.64
Coming Soon	Simon XTi 3/1/1 Crystal package (above) with Z-Wave and CDMA for Verizon, plus 2-way Talking Touchscreen	TBD
IT16059795	Handheld Wireless Touchpad for Concord and Simon wireless systems, with wall bracket	58.30
IT16009400IMAGK	Image Sensor with Daughterboard (first one per system)	127.40
IT16009400IMA	Additional Image Sensor (max of 4)	117.09
IT16009400ZB	Zigbee Daughterboard	15.92



IT1609243XT2WTT



Kwikset Deadbolts on Page 10

Concord 4 Hybrid Panels

Concord 4 is a full-featured security system for intrusion and fire detection. Easy to install and simple to use, Concord's modular design and software provide outstanding system flexibility to meet the needs of virtually any residential or commercial security application. The panel comes standard with eight hardwire zone inputs, including a 2-wire smoke detector loop that can handle up to 20 detectors. A built-in RF receiver with 96-zone capacity provides instant compatibility with the complete line of GE Security Learn Mode sensors.



Concord 4

Concord 4 Starter Packages

Includes panel with wireless receiver, LCD Touchpad, transformer, phone cord, RJ-31x jack & owner's manual (battery not included)

IT1809534	Concord V4 panel, IT16074601 SB2000 2x16 LCD Alpha Touchpad	131.01
IT1809184	Concord V4 3-1-0 Hardwire Kit, IT160983 ATP1000 Alpha Touchpad, (3) SEN1075-N Window Contacts, (1) SEN6540UPI Pet Immune PIR, (1) MPMP135 Speaker	157.50
IT1809834	Concord V4 3-1-0 Wireless SAW Kit, IT160820 SB2000 Fixed English Touchpad, (3) IT16067095R Saw Door/Window Contacts, (1) IT16080795R Pet Immune PIR, (1) IT113469 Siren	232.84
IT18009764	Concord V4 3-1-0 Wireless Crystal Kit, IT16001020 FTP1000 Touchpad, (3) IT160362103195 contacts, (1) IT16080795R PIR, (1) IT113469 Siren	238.51

Concord Family Keypads and Accessories

IT16074601	SB2000 2x16 LCD Alphanumeric Touchpad	73.60
IT160983	ATP1000 Alphanumeric LCD Touchpad, 2x16 display	73.60
IT160820	SB2000 Fixed English LCD Touchpad	51.08
IT16001020	FTP1000 Fixed English LCD Touchpad	58.87
IT16059795	Handheld Wireless Touchpad for Concord and Simon wireless systems, with wall bracket	58.30
IT160010533AT	Concord 4 Alarm.com GSM Kit for AT&T	175.17
IT160010533ZAT	Concord 4 Alarm.com GSM Kit for AT&T with Z-Wave	205.15
IT160010533TM	Concord 4 Alarm.com GSM Kit for T-Mobile	168.62
IT160010533ZTM	Concord 4 Alarm.com GSM Kit for T-Mobile with Z-Wave	198.59
IT160791	Installation/Programming cable, quick plug cable for programming Touchpads	5.35
IT160774	SuperBus 2000 Hardwire Input Module, 8 zones	45.96
IT160757	8-zone Hardwire Input Snapcard (one Snapcard per control panel)	29.84
IT16078302	SuperBus 2000 Automation Module, RS232 for connection to automation systems	52.66



IT160983



IT16074601



IT16059795

Interlogix NetworX

NetworX Family of Products

The NetworX controls are feature-rich, entry-level security systems. The NetworX uses advanced technology for burglary, fire and environmental detection without the high cost of similar controls. The NetworX is a flexible security system that is both easy to install and simple to use. With models starting at 4 zones to models that expand to 192 zones, the NetworX is ideal for apartment, small residential and small commercial applications.

CADNX4KIT	NX4 with NX108E keypad and 16.5V 25VA transformer	66.85
CADNX848KIT	NX8 with NX148E keypad and 16.5V 25VA transformer	143.82
CADNX848EKIT	NX8E with NX148E keypad and 16.5V 25VA transformer	181.17

NetworX FastPacks

CADNX6FP	NX6 with NX1308E keypad, motion detector, speaker, battery, transformer and RJ31x	107.75
CADNX848FP	NX8 with NX148E keypad, motion detector, speaker, battery, transformer and RJ31x	172.46
CADNX8EFP7RF	NX8 with NX148ERF keypad, motion detector, speaker, battery, transformer and RJ31x	229.37

NetworX Controller Quick Chart

(Control panel in enclosure only, needs transformer, battery & keypad)

Part Number	On-board Zones	Maximum Total Zones	Maximum Wired Zones	Maximum Wireless Zones	Price
CADNX4	4 hardwire zones	8	8	8	26.15
CADNX6	6 hardwire zones	16	12	16	39.22
CADNX8	8 hardwire zones	48	48	48	62.66
CADNX8E	8 hardwire zones	192	192	192	94.84

NetworX Expansion Modules and Accessories

CADNX591EGSM	Cellemetry module - digital, provides secure alarm communication, cellular back-up unit	196.72
CADNX590NE	Network module, ethernet communication, reporting and programming	204.02
CADNX216	Zone expander for NX8, 16 zone hardwire expander module, up to 48 zones total	32.51
CADNX216E	Zone expander for NX8E, 16 zone hardwire expander module, up to 192 zones total	57.88
CADNX534E	Two-way voice module	47.76
CADNX540E	NetworX Operator II telephone interface module, also adds X10 capabilities, requires X10 PSC04	69.07
CADP0003	Serial adapter for NX8E only, allows connection of automation controllers	15.43
CADNX584E	Home automation interface module with bi-directional RS232	51.52
CADNX588E	Quicklink direct connect, USB programming adapter for connection to laptop, 4 panel memory	56.20
CADNX590NE	TCP/IP Internet module for central station communication and to email addresses	204.02
CADNX592EZAT	NetworX Alarm.com 3G kit for AT&T with Z-wave (2nd Quarter)	TBD
CADNX592EZXTM	NetworX Alarm.com 3G kit for T-Mobile with Z-wave (2nd Quarter)	TBD
CAD592EZVZ	NetworX Alarm.com CDMA kit for T-Mobile with Z-wave (2nd Quarter)	TBD

NetworX Keypads

CADNX1308E	8-zone LED keypad, 6.2"W x 5.3"H x 1.3"D	42.33
CADNX1448E	192-zone fixed LCD, 6.2"W x 5.2"H x 1.3"D	49.31
CADNX148E	192-zone alpha LCD, 6.2"W x 5.3"H x 1.3"D	88.67
CADNX148ERF	CADNX148E with 48-zone wireless receiver	90.43

CADNX148E

CADNX1448E

Motion Detectors and Glassbreaks

SEN6540UPI	Pet Immune PIR 45' x 40'	10.22
SENRCR-PET	Range controlled radar PIR, 80 lb pet immune, form A	29.63
SEN6550U	Sharpshooter fresnel lens PIR, form C	11.72
SEN6255FM-W	Flush single-gang PIR 30', 90 degree	39.13
SENAP100PI	Mirror optic with 44 lb pet immunity, 33' 90 degree	12.02
SENAP669	Ceiling-mount dual element PIR 60' diameter, form C	89.50
SENRCR-REX-W	Ceiling-mount request-to-exit motion, dual-tech	63.77
SEN5812NT	ShatterPro 3 glass break sensor, form A, rectangular	26.22
SEN5820A-W	ShatterPro II, 1" recess-mount glass break sensor	38.02
SEN5815NT	ShatterPro 3 glass break sensor, form C, round	29.13
SEN5709C-W	Glassbreak tester	45.81
SEN5150-W	Stick-on shock sensor	8.64

SEN5812NT

SEN6255FM-W

SEN5150-W

SEN5820A-W

SENAP669

SENRCR-PET

See pages 189 and 190 for Wire and Cable. See pages 185 - 186 for rough-in boxes

Interlogix Wireless

Transmitters work with GE-compatible receivers and many with the HAI42A00-2 receiver.

Door and Window Contacts



IT160362N103195

IT16068895



ITITX8010-01-1



ITITX6010011



ITITX4014012

ITITX1010011



ITITX6310011



IT16063995R



IT16065995R



IT1605781095



IT16074495R

Caddx part numbers are phased out, shown here for cross-reference		Old CADDX	Price
IT16068895	Micro crystal transmitter, white-1.75" x 0.4" x 0.5	CADNX454	33.70
ITITX1510011	Recessed crystal transmitter - 5/8" x 3.5" hole required	n/a	36.78
ITITX1010011	Designline slim door/window sensor - white - 1" x 2.4" x 0.35"	n/a	37.47
IT160499103195	Slimline crystal transmitter - white- 0.31" x 4.94" x 0.88	CADNX452	38.29
IT160362N103195	White crystal transmitter, remote sensor contacts 1.57" x 3.16' x 1	CADNX650N	33.70
ITITX8010-01-1	Designline tilt-switch garage door sensor, white	n/a	37.47
ITITX-8300-01-1	Designline tri-zone wireless 3-in-1 sensor, white	n/a	46.84
IT16067095R	SAW door/window transmitter, remote sensor contacts	n/a	30.64
IT16064195	Crystal long-life door/window sensor, terminals 1.56" x 3.25"x .88"	n/a	36.78

Fire, Carbon Monoxide and Environmental

ITITX6010011	Wireless smoke alarm with sounder	n/a	67.46
IT160460319.5	Heat Detector 135 degree with rate of rise	n/a	42.89
ITITX6310011	Wireless carbon monoxide sensor	n/a	88.53
IT16074495R	Water detection SAW transmitter	CADNX695	45.06
IT16050410319.5	Freeze transmitter, 45° F, crystal-White	n/a	42.80

Motion Detectors and Glass Breaks

IT16080795R	Wireless 40 lb pet immune PIR motion SAW transmitter	CADNX481	74.55
IT16063995R	Wireless PIR motion transmitter, 35' x 40' area	CADNX480	80.79
IT16063995ROD	Outdoor PIR motion detector, SAW	n/a	101.38
IT16087395	Wireless ShatterPro glass break transmitter, up to 20' away	CADNX488	73.00
IT16088695	Crystal glass shock sensor, white	n/a	51.40

Keyfobs and Panic Alarms

IT1605781095	Pendant panic transmitter - Crystal	CADNX475	37.79
IT16045710319.5	Double-button crystal panic sensor, prevents false alarms	n/a	34.14
IT1600106495R	2-button SAW keychain remote	n/a	24.36
IT160607319.5	2-button crystal keychain remote	n/a	30.64
IT1600106495R	Designline 4-button keyfob	n/a	24.36
IT160606319.5	4-button crystal keychain remote	n/a	35.75
IT1600106495R	4-button micro keyfob	n/a	24.36

Receivers and Repeater

IT1606600195R	Quick Bridge, adds wireless to any security panel, provides up to 16 sensors to 8 zones of the control	CAD8016	70.19
CADNX548E	48-zone wireless expansion, compatible with any NetworX panel, 1000ft open-air range, accepts all GE transmitters above	CADNX548E	47.47
IT160010250195R	SuperBus 2000 transceiver module, for Concord control panels, not needed for Concord 4	n/a	84.26
IT180922-01	GE wireless repeater kit- can solve supervisory issues	CADNX707	159.15

Z-wave Modules



EVOLDM-15	Lamp module, 300W plug-in, dimmable	39.90
EVOLPM-15	Appliance module, 15A plug-in, relay	39.90
EVOLTM-5	Decorator style transmitter for "virtual" 3-ways, neutral required	39.90
EVOLRM-AS	Decorator style wall switch, 500W, neutral required, single-pole dimmable	39.90
EVOLSM-15	Decorator style wall switch, 15A, neutral required, single-pole, relay	39.90
EVOLOM-15	Decorator style 15A outlet, neutral req., top controlled, bottom always on, relay	39.90
EVOLFM-20	Fixture module, 15A, neutral req., isolated relay for contact closure or voltage	51.90
AEODSA03202W-US	Z-Wave Minimote 4-Button Controller (White) to program the EVOLTM-5	42.84



EVOLSM-15

Color Change kits available: Almond, Black, and Brown

Sentrol Magnetic Contacts

All contacts below are "closed-loop"/ form A type for security system applications unless otherwise noted

Part #	Type	Description	Size	Use	Each
SEN1075W-N	Recessed	3/8" dia., with leads, 1 1/4" wide gap	1.313 x 0.375 dia	Windows	2.12
SEN1055W-N	Recessed	1/4" dia., with leads, 1 1/4" wide gap	1.125 x 0.25 dia	Windows	2.50
SEN1075-N	Recessed	3/8" dia., with leads, 1/2" gap	1.313 x 0.375 dia	Windows	1.11
SEN1125W-N	Recessed	3/8" dia., stubby with leads, 3/4" gap	0.75 x 0.44 dia	Windows	1.26
SEN1125T-N	Recessed	3/8" dia., stubby with terminals, 3/4" gap	1.08 x 0.375 dia	Doors / Windows	1.76
SENR1125-N	Recessed	3/8" dia., with leads, rare earth, 1/2" gap	0.75 x 0.44 dia	Doors / Windows	1.41
SEN1078CW-N	Recessed	3/4" dia., with leads, 3/4" gap	1.563 x 0.75 dia.	Steel Doors	6.73
SEN1275W-N	Recessed	3/8" dia., wing-fit , leads, 1 1/4" wide gap	1.313 x 0.375 dia	Wood Doors	3.02
SEN3008W	Recessed	3/4" dia., Roller Plunger	0.80 x .075 dia	Doors	3.52
SEN1138T-N	Surface	Surface-mount with terminals, 1" gap	2. x 0.34 x 0.40	Windows	1.71
SEN1035-N	Surface	Self-stick, with leads, 5/8" gap	1.5 x 0.375 x 0.25	Windows	2.47
SEN1285TW-N	Surface	Designer cover, terminals, 1 1/2 wide gap	2.54 x 0.545 x 0.69	Wood Doors	4.13
SEN1085W-N	Surface	Screw-mount with leads , 1.5" wide gap	2.0 x 0.375 x 0.375	Doors / Windows	4.37
SEN2505A-L	Surface	Industrial with armored cable	3.0 x 0.5 x 1.0	Steel Doors	22.01
SEN2302A-L	Surface	Rail-mount for curtain door, 3" gap	3.63 x 3.0 x 0.65	Curtain Door	31.91
SEN2317A-L	Surface	Rail-mount for overhead door, form C, armored cable, 3" gap	3.07 x 2.6 x 1.8	Overhead Doors	24.87



SEN1075-N



SEN1125T-N



SEN2317A-L



SEN1275W-N

Life Safety Devices

ESL260-CO	"Safeair" carbon monoxide detector with test/hush	54.81
ESL250-COPLT-5P	Mounting Plate Adapts 250-CO to 240-COE hole, 5 pack	9.32
ESL541NBXT	4-wire, 8.5-33VDC smoke, fixed temp & rate-of-rise heat	35.77
ESL541NCSXT	4-wire, 8.5-33VDC smoke, fixed temp, rate-of-rise & sounder	39.77
ESL541NCSXTE	4-wire, 8.5-33VDC smoke, heat, sounder, & end-of-line relay	41.84
ESL405-03	12V polarity reversal module	25.09
ESL204-12/24V	12/24V power supervisory unit, end-of-line, needed for 4-wire smokes	12.47
ESL511C	2-wire, 12-24VDC basic smoke detector	23.18
ESL521BXT	2-wire, 6-24VDC smoke, fixed temp & rate-of-rise	26.35
ESL521NCSXT	2-wire, 6-24VDC smoke, fixed temp, rate-of-rise & sounder	31.90
ESL104-13	Heat detector - 135°, fixed temp & rate-of rise	8.66
ESL282B-PL	Heat detector - 194°, fixed temp & rate-of rise	Call
ESL104-15	Heat detector - 135°, fixed temp	8.66
ESL284B-PL	Heat detector - 194°, fixed temp	7.18



ESL500 Family



ESL104-13



ESL260-CO

Four Wire Diagram

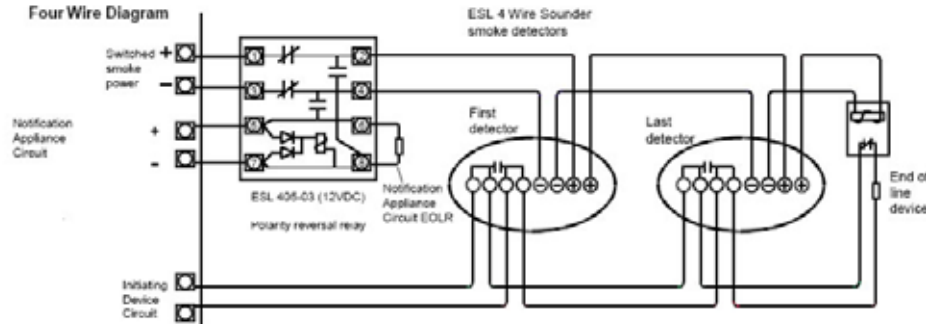

TECHNICAL NOTES:

- Worthington recommends wiring with 4-conductor, even if you plan on using 2-wire smokes. This provides you with solutions if there is a need to revise the smoke detector or sounder plan later.
- The proper installation of a 4-wire smoke detector system includes an end-of-line relay to supervise the power lines of the smokes.
- If you use 2- or 4-wire smokes with sounders, you also need a polarity-reversing relay to cause all sounders to trigger when an alarm occurs.

Sirens, Drivers, and Speakers

MPMPI-47	Piezo siren 106dB, surface-mount	16.90
MPMPI-47C	Piezo siren, 106dB, ceiling-mount	11.24
MPMPI-47E	Piezo siren, 106dB, single-gang J-box	11.24
MPMPI-11	Siren driver, yelp/steady, 115dB, 8-15VDC	14.50
MPMPI-34	Speaker, 30 watts, metal bail bracket	16.90
MPMA-2	Pre-alert piezo sounder, 100dB	12.74



MPMPI-47 family



MPMPI-34

Resolution Products offers an array of common usage and specialty wireless security devices. Most notable are their takeover translators. Now you can replace that "other guy's" control panel without needing to replace all the wireless devices in the house. They also carry repeaters and other devices compatible with major wireless security panels.

Hardwire Takeover Translator

- 8 Hardwire loops with end-of-line resistor detection
- Unique wireless ID (or loop) for each zone
- Unique wireless ID for the device itself
- Transmit diversity for long reliable range
- External 12VDC power supply (sold separately)
- 3-5 year backup on AA batteries (included)
- Device low battery detect and device tamper detect



Takeover

RESRE308	Takeover, from hardwire-to-DSC	56.20
RESRE108	Takeover, from hardwire-to-GE	56.20

Repeaters

RESRE320	Repeater, DSC compatible	64.95
RESRE120	Repeater, GE compatible	64.95
RESRE220	Repeater, Honeywell compatible	64.95
RESRE220T	Repeater, 2GIG compatible	64.95
RESRE012	12VDC 100 mA power supply for repeaters and translators	5.62

Wireless Takeover Translator

Wireless Takeover Translator

- Enrolls up to 63 devices, with unique ID for each
- Translates each sensor's alarm, supervisory and trouble signals
- 72 hour backup on 3 AAA batteries (included)
- External 12VDC power supply required (sold separately)
- Dual antennas for Receive/Transmit diversity ensure reliable range
- Separate ID for supervision of Translator's tamper, power supply and battery



RESRE324GD	Translator, from GE wireless to DSC	56.20
RESRE324HD	Translator, from Honeywell wireless to DSC	56.20
RESRE324ND	Translator, from Napco wireless to DSC	56.20
RESRE324TD	Translator, from 2GIG to DSC	56.20
RESRE224GT	Translator, GE wireless to 2GIG	56.20
RESRE224DT	Translator, DSC wireless to 2GIG	56.20
RESRE124HG	Translator, Honeywell wireless to GE	56.20
RESRE124DG	Translator, DSC wireless to GE	56.20
RESRE124NG	Translator, Napco wireless to GE	56.20

Alternative Wireless Security Devices



Driveway Sensor



Hidden Panic



Mighty Mouse

Interlogix Compatible

RESRE100	4-Button Keyfob	16.24
RESRE101	Door/Window, also supports external	21.23
RESRE102	Pencil Door/Window	18.74
RESRE103	Panic, Wrist Band	18.74
RESRE104	Driveway Sensor	94.92
RESRE105	Temperature Range Sensor	24.98
RESRE106	Tilt Sensor, great for Garage doors	24.98
RESRE110P	PIR, Pet Immune to 60lb	49.96
RESRE111	Mighty Mouse Micro Sensor	23.11
RESRE119	Home Disaster Transmitter	41.22
RESRE151	Hidden Panic	24.98
RESRE152	PINpad, remote Keypad	32.47

Universal Wireless Siren

RESRE116-U	Wireless Universal Siren with Transmitter	94.92
RESRE116	Wireless Siren only	67.45



Door / Window Contact



Keyfob



Wrist Panic

2GIG/Honeywell Compatible

RESRE200RW	4-Button Keyfob	16.24
RESRE201	Door/Window	21.23
RESRE203	Panic, Wrist Band	18.74
RESRE204	Driveway Sensor	94.92
RESRE205	Temperature Range Sensor	24.98
RESRE206	Tilt Sensor	24.98
RESRE210P	PIR, Pet Immune to 60lb	49.96
RESRE211	Mighty Mouse Micro Sensor	46.21
RESRE219	Home Disaster Transmitter	41.22

DSC & Napco compatible versions also available

Alarm System Takeover



Ion Security was formed with the purpose of creating new, innovative wireless products for the residential and commercial security markets. The products below are examples of new styles of transmitters. Expected range of 500 feet. They are compatible with the GE, 2GIG, HAI and DSC wireless receivers. Please specify which receiver you are working with.



IONMICRA-G



IONPLUNGER-G

IONMICRA-HA	HAI compatible concealed wireless window sensor, 1/2" deep, 3/4" wide, low profile magnet	24.98
IONPLUNGER-HA	HAI compatible concealed wireless door sensor, 1" deep, 3/4" wide	24.98
IONMICRA-2G	2GIG compatible concealed wireless window sensor, 1/2" deep, 3/4" wide, low profile magnet	24.98
IONPLUNGER-2G	2GIG compatible concealed wireless door sensor, 1" deep, 3/4" wide	24.98
IONMICRA-G	GE compatible concealed wireless window sensor, 1/2" deep, 3/4" wide, low profile magnet	24.98
IONPLUNGER-G	GE compatible concealed wireless door sensor, 1" deep, 3/4" wide	24.98
IONMICRA-D	DSC compatible concealed wireless window sensor, 1/2" deep, 3/4" wide, low profile magnet	24.98
IONPLUNGER-D	DSC compatible concealed wireless door sensor	24.98
IONFDB75	3/4" Forstner drill bit for drilling perfect holes	6.24
IONWG125	Micra extra-strength magnet for window gaps up to 1.25"	3.12

PERS with Interactive and Environmental Sensors

VISAMBERX	Advanced console, two-way voice, waterproof wristband or pendant transmitter, battery pack, phone line, program cable, software, transformer	212.33
VISAMBERLINK	Advanced console with cell option	161.12
VISAMBERLINKUSB	USB Programming Kit for AmberLink	45.90
VISM CX600P	Repeater, range extender	98.92

Call us for optional cellular cards for the Amberlink system, including two-way voice capabilities (to be announced).

VISMCT212P	Additional waterproof pendant	42.63
VISMCT241P	Waterproof emergency fall detector	65.57
VISMCT201WP	Waterproof pendant: arm/disarm, panic	32.02
VISMCT220PERS	Large emergency button	32.14
VISMCT220SLEEVE	Rubber sleeve for the MCT220 button	1.31
VISMCT302PERS	Door/window/inactivity transmitter	33.36
VISK985MCW	Pet immune motion/inactivity transmitter	69.03
VISMCT550PERS	Wireless water/flood detector	44.85
VISMCT425PERS	Wireless smoke detector	68.07
VISMCT442PERS	Wireless carbon monoxide detector	78.69

AmberSelect-X and AmberLink are complete, affordable Personal Emergency Response Systems (PERS). They include the capabilities families want most in a single, easy-to-sell-and-install package including:

- Medication and daily task reminders
- Environmental safety detection, including wireless smoke, flood and CO
- One-button emergency dialing
- Two-way speakerphone
- Programmable speed dial numbers
- Inactivity and fall monitoring

Voice Dialers

While the best solution for security monitoring is still a central station, many homeowners are requesting that their security systems call their cellphones, either as a primary or secondary notification. The DL125V is an automatic programmable speech dialer with two alarm inputs designed for verbal reporting of two separate events. Events can be reported to four different remote telephones.

VISDL-125C

VISDL-125C	Voice dialer, 12VDC power supply not included	92.09
------------	---	-------

Security Detectors

VISGLASSTECH	GlassBreak microprocessor controlled	30.19
VISDISC	Small 360 ceiling-mount, 36" at 12' height	30.64
VISDUO240	Small digital dual PIR ceiling-mount	56.52
VISNEXTDUOK985	Dual tech, 80lb pet immune w/ TSI, 40'	37.47
VISK940-UL	Pet immune 40lb, 30' x 30'	12.49
VISK985+	Pet Immune 85lb, 50' x 50'	19.25
VISDUO200	Small digital dual PIR 40' x 40'	36.98
VISTOWER20AMMCW	Outdoor 40' x 40', anti-vandal, anti-mask	17.90
VISTOWER12AM	Industrial dual tech, 82' x 100'	73.44
VISVI-PET	Compact PIR with 60lb pet immune	9.84
VISDA-5	Request-to-exit PIR detector	42.75

Micro PIRs

Some of the smallest PIRs in the industry. The Clip PIR is 2 3/4" tall and 1 1/4" wide. The Spy PIR recesses into a 7/8" hole and is 2 3/4" wide.

VISCLIP-1	Micro PIR, wide angle, 30' x 40'	31.50
VISCLIP-4	Micro PIR, 12' solid curtain	31.50
VISSPY-1	Micro PIR, flush-mount, 35' long range	45.58
VISSPY-2	Micro PIR, flush-mount, 25' 50°	45.58
VISSPY-3	Micro PIR, flush-mount, 25' 100°	45.58
VISSPY-4	Micro PIR, flush-mount, 12' solid curtain	46.66
VISSPY-RTE-B	Micro PIR, for access, contact output	47.30

Occupancy Sensors

VISDISC-ET	Ceiling-mount, 360 degree, 30' coverage	61.03
------------	---	-------

Outdoor Motion Detectors

OXLX402	Outdoor PIR motion detector, double shielded, form C relay output	79.94
OXBX80N	80' x 3' outdoor narrow PIR, protects perimeter windows/doors, NO/NC relay	134.89
OXHX40	High-mount outdoor motion detector, 10' high, 40' range	154.88
OXVX402	40'x40' Outdoor dual PIR with voice warning facility	136.14
OXFTNST	Compact outdoor dual detector for windows, doors, balconies, etc.	86.18



Many detectors are also available in a battery-powered version that can be added to any wireless system with a transmitter.

Photoelectric Beam Detectors

OXAX100TF	100' outdoor photoelectric beam, quick optical alignment, NO or NC relay	199.84
OXAX200TFR	200' Wireless outdoor photoelectric beam	509.59
OXBX100PLUS	BoundaryGard 100' outdoor photobeam for multiple windows/doors, NO/NC relay	131.14
OXAX650TF	650' outdoor photoelectric beam, alignment status for easy setup, NO/NC relay	467.13



Elk requires we publish MAP prices. Please call 800-282-8864 or use your on-line account for discounted Worthington Distribution Dealer prices.

Siren and Voice Drivers

ELK100	High perf. driver with 2 inputs & 2 volume levels	25.43
ELK120	Recordable annunciator, 8 minutes, 3 sounds	109.84
ELK124	Recordable voice annunciator in enclosure	161.87
ELK129	Computer interface for recordables	71.36



ELK100 ELK110 ELK120 ELK124 ELK129

Universal Accessories

ELK9002	B Connectors (Plain), 500 pieces-Yellow	23.50
ELK9022	B Connectors (Gel), 500 pieces-White	28.43
ELK930	Telephone and doorbell ring detector	56.91
ELK99805	5 laminated self-adhesive alarm decals	10.79
ELK999	Double-sided tape, 130 pc., 1/2"x1 1/2"x1/4"	10.86
ELKPB1	Plastic project box with tabs, 4 3/8" x 6 1/2" x 2"	10.00



ELK900-2/
ELK902-2 ELK930 ELK999 ELK998-05 ELKPB1

Relay Modules and Timers

ELK912	12V compact relay module, SPDT	8.80
ELK91212	12V compact relay module, SPDT, 12-pack	78.76
ELK941	Alarm output director, 2 SPDT outputs	36.36
ELK912B6	12/24V relay with big terminals, SPDT, 6-pack	47.07
ELK924	12/24V sensitive relay module, DPDT	13.93
ELK9244	12/24V sensitive relay module, DPDT, 4-pack	50.00
ELK960	12/24V delay timer, adjustable 1 sec.-60 min.	29.21

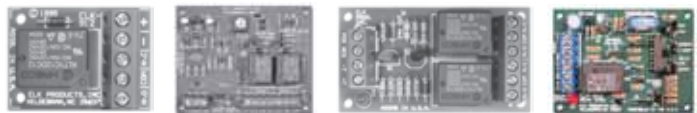

ELK912 ELK941 ELK924 ELK960

Surge Suppressors

ELK950	Surface-mount telephone & AC line surge	30.00
ELK951	Surface-mount single telephone line surge	27.39
ELK952	In-Line Telephone Surge Protector	19.07
ELK955	Surface-mount dual telephone line surge	43.43



ELK950 ELK951 ELK952 ELK955

Speakers

ELK44	30W RMS/50W peak with "U"-shaped bracket	20.50
ELK70	Interior 20W with hardware (paintable)	15.61
ELKSP30	Exterior surface mount 30Watt, 8 Ohm Speaker	17.07
ELKSP35	Interior surface-mount 20W with hardware	8.96
ELKSP12F	Interior flush mount 12W fits single gang box	8.23
ELK1RT	30W speaker in stainless steel enclosure	57.93
ELKSL1*	Strobe for above speaker *- color: A-Amber, B-Blue, C-Clear, R-Red	28.99
ELKWK1	Wall-mount Kit for ELKSL1 Strobe Light	8.50



ELK44 ELK-SP30 ELKSP12F ELK1RT ELKSL1 ELKWK1

Sirens (Compact, Self-Contained)

ELK45	Heavy duty, with "U"-shaped bracket	28.64
ELK71	Interior 100db with hardware (paintable)	17.50
ELK74	Interior compact 105db with hardware (paintable)	14.30
ELKSS36	Two-tone interior siren	9.40
ELK150RT	118db siren in stainless steel enclosure. Use ELKSL1 to add strobe.	65.26
ELKSS15	Exterior two-tone 115db	10.87
ELKSS30	Two-tone siren, 120db, surface	17.21



ELK45 ELK71 ELKSS30 ELKSS15

Power Products

ELKBLT	Battery analyzer, 12V, .5A to 65A	204.29
ELKP112K	Supply, 1A@12Vdc with TRG1640 & 1250	95.90
ELKP1216	Plug-In Power Supply 12VDC 1.5A 2.5mm jack	28.56
ELKP412	Supply, 4A@12Vdc with power cord	197.30
ELKP624	Power supply board, 1.2A, 6, 12 or 24Vdc	23.93
ELK965	Low battery cutoff and master power switch	19.43
ELKPD9	Power module, up to 9 devices, auto reset	44.06
ELK1250	Rechargeable 12V, 5Ahr battery	18.60
ELK1280	Rechargeable 12V, 8Ahr battery	26.49
ELKTRG2440	Transformer, 24V, 40VA, LED, ground, PTC	14.14
ELKTRG1640	Transformer, 16V, 40VA, LED, ground, PTC	14.14



ELKBLT ELKP412 ELKP112K ELKTRG1640/2440 ELKP624 ELK965 ELKPD9 ELK1250 ELK1280

Power Supplies - Great for Adding More Power to your HAI Omni Controller

ALTAL624	1.2A @ 12VDC & 0.75A @ 24VDC, requires 24VAC transformer feed, see below, board only	10.39
ALTAL624E	1.2A @ 12VDC & 0.75A @ 24VDC in enclosure, requires 24VAC transformer feed, see below	31.85
ALTSMP3E	6VDC, 12VDC or 24VDC @ 2.5 amp of continuous output, requires 24VAC 100VA transformer feed, with enclosure	45.79
ALTSMP5	6VDC, 12VDC or 24VDC @ 4 amp of continuous output, requires 24VAC 100VA transformer feed, board only	39.91
ALTAL175ULB	1.75A @ 12/24VDC power supply with fire alarm interface, 2 power limited outputs, board only	52.46
ALTAL300ULB	2.5A @ 12/24VDC supervised AC and battery monitoring, limited output, board only	67.76
ALTAL300ULXR	UL fire listed 2.5A @ 12VDC or 24VDC in enclosure, supervised power supply/charger, 115VAC input	136.45
ALTAL400ULXB	UL burglary listed 4A @ 12VDC or 3A @ 24VDC board only, power supply/charger, 115VAC input	117.72
ALTAL600ULM	6A @ 12/24VDC multi output power supply in enclosure with fire alarm interface AC and battery supervision	281.02
ALTAL600ULACM	6A @ 12/24VDC access power controller in enclosure with fire alarm interface, 8 fail safe or fail secure	294.76



ALTAL624



ALTAL624E



ALTAL175ULB

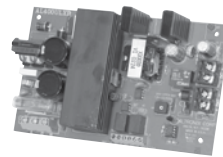

ALTAL400ULXB



ALTSMP5



ALTAL600ULM

CCTV Power Supplies

ALTSAV4D	UL CCTV listed, 4 PTC outputs, 12VDC @ 5 amp, with power linecord	51.33
ALTSAV9D	UL CCTV listed, 9 PTC outputs, 12VDC @ 5 amp, with power linecord	73.38
ALTSAV18D	UL CCTV listed, 18 PTC outputs, 12VDC @ 5 amp, with power linecord	118.66
ALTV248	8 fuse-protected regulated outputs, 24VAC @ 4A power supply, 115VAC input	60.71
ALTV2416	16 fuse-protected regulated outputs, 24VAC @ 8A power supply, 115VAC input	103.38
ALTV615DC616UL	16 fuse-protected regulated outputs, 6-15VDC @ 6A power supply, 115VAC input	137.39
ALTV615DC1016	16 fuse-protected regulated outputs, 6-15VDC @ 10A power supply, 115VAC input	156.12
ALTALTV2432600U	12.5A @ 24VAC or 20A @ 28VAC 32 fused outputs; wall-mount	194.22
ALTR2416300UL	25A @ 24VAC or 10 A @ 28VAC 16 fused outputs 2U rack-mount power supply	231.06



ALTSAV4D



ALTSAV9D



ALTV248



ALTV615DC616UL



ALTR615DC1016

Low Voltage Coil DPDT Relays

ALTRBSN	12V/24VDC 15mA coil, 2A @ 115VAC/28VDC	8.12
ALTRBST	6V/12V/24VDC, 30mA coil, 2A @ 115VAC/28VDC	8.12
ALTRDC12	12VDC 86mA coil draw, 10A @ 120VAC/28VDC	14.43
ALTRAC24	24VAC 86mA coil draw, 10A @ 120VAC/28VDC	14.43
ALTRAC120	120VAC 12mA coil draw, 10A @ 120VAC/28VDC	14.43



ALTALSD1

ALTALSD1	6V/12VDC operation, steady & yelp, current draw .5A to 1.8A depending on speaker	11.62
ALTALSD2	Same as above except current draw .3A to 1.22A depending on speaker	8.37

Note: HAI Omni Controller bell output is rated for 1A - Use Altronix for UL Listing Integrity

Timers

ALT6062	12V/24VDC, 1-60 mins, 8A @ 115VAC/28VDC	16.49
ALTAT4	4 ch. 12/24V AC/DC, 10A @ 115VAC/28VDC	156.12
ALTDL1	Door control timer, 12/24V AC/DC, 1 sec. to 1 min.	28.85
ALTDL3	Same as above with rectified voltage output	37.47
ALTPT724A	Annual event timer 50 daily/weekly events	66.82

Batteries and Plug-in Transformers

ELKTRG2440

ELKTRG2440	Self resetting 24VAC/40VA transformer	14.14
ELKTRG1640	Self resetting 16.5VAC/40VA transformer	14.14
UB1250	12VDC/5AH sealed lead acid battery	11.01
UB1270	12VDC/7AH sealed lead acid battery	12.79

Worthington Distribution Carries the Full Altronix Product Line - Call for Pricing and Availability

Security Contacts

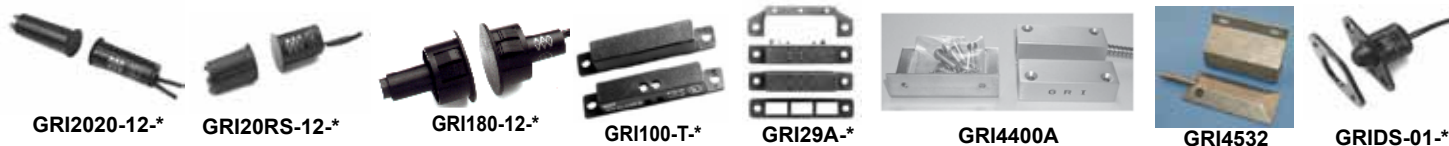

All contacts below are "closed-loop"/ form A type for security system applications. Other loop types are available.

Part #	Type	Description	Size	Color	Use	Each
GRI20RS-12-*	Recessed	3/8" stubby with leads, 1/2" gap	0.6" x 0.375" dia	wht, brn	Windows	2.34
GRI20RS-T-*	Recessed	3/8" stubby set with terminals, 1/2" gap	0.93" x 0.375" dia	wht, brn	Windows	2.62
GRIN2020TWG-*	Recessed	3/8" rare earth magnet, wide gap	1.25" x 0.375" dia	wht, brn	Windows	3.11
GRIN20RS-T-*	Recessed	3/8" stubby, term, rare earth mag.	1.25" x 0.375" dia	wht	Windows	3.01
GRI7377-W	Recessed	3/8" stubby set w/ terminals and 1K resistor	1.25" x 0.375" dia	wht	Windows	3.81
GRIPBF-2020-T-W	Recessed	3/8" dia plunger switch w/ term & flange	1.36" x 0.375" dia	white, brn, gry	Windows	2.81
GRI500-BR	Surface	Micro stick-on contact	1" x 0.26" x 0.25"	wht, brn	Windows	2.39
GRI2120-12WG	Recessed	3/8" dia., with leads & ribs, 1" gap	0.92" x 0.375" dia	white	Doors / Windows	2.45
GRI2020-12-*	Recessed	3/8" dia., with leads, 1/2" gap	0.92" x 0.375" dia	wht,brn,gry,blk	Doors / Windows	1.84
GRI2020-12WG-W	Recessed	3/8" dia., with leads, 1" gap	0.92" x 0.375" dia	wht,brn,gry,blk	Doors / Windows	2.24
GRI2020-T-W	Recessed	3/8" dia., terminals, 1/2" gap	1.250" x 0.375" dia	wht,brn,gry,blk	Doors / Windows	2.24
GRI2120-12	Recessed	3/8" dia., with leads & ribs, 1/2" gap	0.92" x 0.375" dia	white	Doors / Windows	2.15
GRI100-12-*	Surface	Mini set with flange, 1" gap	1.75" x .375" x .302"	wht,brn	Doors / Windows	2.25
GRI100-T-*	Surface	Mini set with flange and terminals, 1" gap	1.75" x .375" x .302"	wht,brn	Doors / Windows	2.37
GRI100-TWG-*	Surface	Mini set with flange, term, 1.25" wide gap	1.75" x .375" x .302"	wht,brn	Doors / Windows	2.69
GRI110TW	Surface	Mini set with term, self adhesive, 1" gap	1.5" x 0.375" x 0.312"	wht,brn	Doors / Windows	2.37
GRI29A-*	Surface	Flanged with side screw term., 1" gap	2.1" x .52" x .55"	wht,brn	Doors / Windows	2.24
GRI29AWG-*	Surface	Flanged with side screw term., 1.5" wide gap	2.1" x .52" x .55"	wht,brn	Doors / Windows	3.07
GRI505-*	Surface	Super miniature set with screw holes, 1/2" gap	1" x 0.180" x 0.265"	wht,brn	Doors / Windows	2.39
GRIDS-01T-*	Recessed	3/4" dome switch, screw down flange w/ term.	1.105" x 0.74" dia	wht, brn	Doors	3.78
GRIRB01-*	Recessed	3/4" roller ball plunger	1.60" x 0.74" dia	wht, brn	Doors	3.47
GRI180-12-*	Recessed	3/4" steel door set, 1/2" gap	0.96" x 0.74" dia	wht,brn,gry,blk	Doors	2.81
GRI180-12WG-*	Recessed	3/4" steel door set, wide gap, 1" gap	0.96" x 0.74" dia	wht, brn	Doors	3.96
GRI4700-A	Surface	Industrial track mount for overhead doors	1.75" to 4" channel	aluminum	Overhead Doors	32.76
GRI4460A	Surface	Mini industrial set, 1" wide gap, armored lead	1.5" x .586" x .426"	aluminum	Steel Doors	7.92
GRI4532	Surface	Miniature overhead door set, 3" wide gap	3.5" x 1.5" x .4"	aluminum	Overhead Doors	9.52
GRI4400A	Surface	Rail mount garage door, 2 1/2" wide gap	3.07 x 2.6 x 1.8	aluminum	Overhead Doors	21.37

Automation Contacts

All contacts below are "open-loop"/ form B type for low voltage switch applications.

GRI101-T-*	Surface	Mini set with flange and terminals, 1" gap	1.75" x .375" x .302"	wht,brn	Special Application	3.98
GRI8585T-*	Recessed	3/4", open loop, form B, 1/2" gap	0.96" x 0.74" dia	wht,brn	Special Application	3.83
GRI506-W	Surface	Super miniature set, open loop, 1/2" gap	1" x 0.180" x 0.265"	wht,brn	Special Application	4.00

Specialty Devices

GRI has a wide selection of specialty devices, call for details

GRIDM-1	Garage Monitor and Closer	54.89
GRIDPA-10D	Pool door alarm, notifies if children open door to pool area, 7-second delay for adults	39.28
GRICC-01	Current controller, control a closet light with just a door contact	29.80
GRISP-17	Panic button - single-gang stainless plate with red panic button and guard ring	15.87
GRI2600	Water sensor, normally closed, 4-wire, 12VDC	12.38
GRI2600T	Water sensor with terminals for 2 included remote sensors (GRI2600T-P), 4 wire	19.93
GRI2800	Surface mount water sensor, 2 wire, requires relay for security system	8.48
GRIWVS	Water shut-off valve w/ sensor, 1" pipe, additional locations with GRI2600	226.59
GRIHVAC	Protect outside HVAC unit from theft damage	19.23
GRIT8000-G	Freeze alarm, thermal 32-degree switch	24.87
GRIE-Z58COM-W	E-Z duct raceway 5/8" combo pack of connectors	7.23
GRIE-Z586-W	E-Z duct raceway 5/8" 6-pack of 6-ft lengths	36.15
GRIE-ZQR6-W	E-Z duct 1/4 round wire raceway- 6-pack	43.25
GRIPW375W	Pre-wire plug- low cost way to pre-wire new construction projects (sold in bag of 100)	0.11

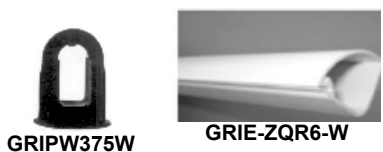
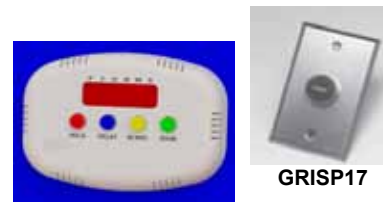

EnviroAlert



WIEA800



WITEMP-UL-S

WIEA800	8-zone (4 wireless, 4 hardwired), temp., humidity, water detection and measurements	344.45
WIEA800-IP	Same as above but adds Ethernet connectivity and remote access	468.38
WIEA40012	4-zone, supports four sensors: temp, humidity, and water detection	192.03
WIEA20012	2-zone, built-in temperature. Supports one sensor: temp, humidity or water detection	77.45
WITEMP-H-S	Stainless steel high temp probe (+32° to +299° F) (also available in waterproof, see below)	48.96
WITEMP-L-S	Stainless steel low temp probe (-58° to +158° F) (also available in waterproof, see below)	34.97
WIHA-IIIPLUS	Humidity sensor (5% to 95% R.H.)	112.04
WIW-S-S	Supervised water sensor, surface (for use with WB800 and EnviroAlert products)	19.55
WITEMP-UL-S	Ultra-low temp probe (-112° to +32° F) (For use only with EA800 and EA800-IP)	62.95
WITEMP-L-W	Waterproof low temp probe (-58° to +158° F)	37.72
WITEMP-H-W	Waterproof high temp probe (+32° to +221° F)	51.71
WIEAWTS	Wireless temperature sensor* (+32° to +122° F)	74.69
WIEA-WHS	Wireless humidity sensor* (5% to 95% R.H.)	101.29
WIEA-WMFS	Wireless multi-function sensor*, requires Winland temp probe or W-S-S water sensor	78.42

*Wireless sensors are only for use with the EA800 and the EA800-IP

Temperature and Humidity Alerts



WITA-1

WITA-1	Temp Alert with dry contact output, adjustable high and low set points	43.68
WITA-2HL	Temp Alert with 2 dry contact outputs, adjustable high and low set points	48.26
WITA-40	Fixed Temp Alert with 2 dry contact outputs, NC for above 40° F/NO for below 40° F	12.74
WIMTA-1	Mechanical Temp Alert, 2 dry contact outputs, +32° to +100° F range	42.64
WIHA-1	Humid Alert w/ SPDT micro-switch, adjustable setting	71.82

WaterBugs and Accessories



WIWB200

WIWB200	WaterBug 200, 12 or 24VAC or VDC, includes 1 WIW-S-U, use up to 6 sensors	52.96
WIWB350	WaterBug 350, 9V battery, includes 1 WIW-S-U, use up to 6 sensors (battery not included)	66.36
WIWB800	WaterBug 800, 12 or 24VAC/VDC, includes 4 WIW-S-S, up to 8 zones or 16 sensors	213.12
WIW-S-U	Additional surface sensor for WB-200 and WB-350, 15' cable	16.24
WIW-UC-U	Under-carpet sensor for WB-200 and WB-350, 15' cable	40.79

Vehicle Alerts

WIVAL-1	Vehicle Alert system, includes console, probe w/ 100' cable & transformer, components also sold individually	239.21
---------	--	--------



Worthington carries the full line of USP Products.

Miscellaneous Sensors



USP908

USP904	Pressure mat, 24" x 30", use with security/automation panels	64.76
USP904PR	Pressure mat, 24" x 24", use with security/automation panels, pet resistant, activates at 60 lbs.	73.63
USP908	Pressure mat, 14' x 24" roll, use with security/automation panels	38.16
USP908PR	Pressure mat, 14' x 24" roll, use with security/automation panels, pet resistant, activates at 60 lbs.	42.28
USP330W	Vibration sensor, use on wall, doors, windows, safes, etc., NC contact, non-powered	3.68
USPHUB2A-ES	Hold-up button, latching, double pole, double throw	13.05
USPF20	Temperature supervisory switch, opens at 40° F, use with security/automation panels	12.43
USPWLS	Water level sensor, NC/NO, use with security/automation panels	12.30
USP714*	Stick-on window glass break sensor, no power required. *B - Bronze, W-White	10.12
USPPLS	Power loss sensor for 110VAC, dry contact output, automatic reset	22.17

Dialers



USPAD2000

USPAD2001	2-zone, calls up to 4 numbers	153.56
USPAD2000	4-zone, calls up to 8 numbers	187.29

Both the 2-zone and 4-zone are also available with a wireless receiver built-in. Cellular models are also available.

- Built-In Line Seizure
- Remote Turn Off feature allows termination of activated channel
- EEPROM Memory retains program despite power loss
- Listen-In verification & communication
- Built-In Auxiliary Output to drive external siren, strobe or relay

Video Door Entry Systems

The advantage of the Comelit system is the ease of installation - simple 2-wire installation between the door station and video monitor. Door release capability comes standard on all Comelit kits. Additional monitors and door stations can be conveniently added, even on multi-tenant applications.

Cyrex Video Door Intercom Systems for Single Family Dwellings

CYXHFX-720M	Color hands-free video intercom kit with 3.5" LCD monitor. Kit includes master monitor, doorbell and power supply. Max capacity for the system is 2 doorbells and 4 monitors.	281.02
CYXEX-720H	Color expansion hands-free monitor for the HFX-700 series. Includes monitor and power supply.	182.35
CYXEX-720D	Color expansion doorbell camera for HFX-720 series, surface and flush-mount boxes included	114.91
CYXEX-VIN	Video input unit for composite camera to allow it to be viewed on HFX-720 series kits	33.72
CYXEX-HUB	4-port home-run hub. Can be used with 720 Series.	59.95
CYX6117U	Pre-construction box for EX720 monitors	5.00
CYX6118	Retrofit Dry-Wall bracket for EX720 monitors	11.24
CYX6312	Desk Base for Monitor	149.88



**CYXEX-720H
CYX6302**



CYXEX-720D

Multi-Tenant Options

Video Door Intercom Systems for up to 6-Tenant Building

CYXPV6S	EZ-Pack Powercom video surface-mount 6 push-button entry panel kit, requires mixer	679.46
CYX4888CU	Mixer & power supply for Simplebus color and B/W systems	269.78
CYX6302	Smart Series System hands-free color monitor	279.78
CYX6320	Surface-mount support for smart monitor	9.99



CYXPA6S



CYXPV6S

Audio-Only Door Intercom Systems for up to 6-Tenant Building

CYXPA6S	EZ-Pack Powercom audio surface-mount 6 push button entry panel kit	380.94
CYX6228W	Easycorn audio only hands-free intercom station	57.45

**Do you have a larger application? Between 1 and 240 apartments?
We can have a Comelit door entry system custom designed for you.**

Telephone Entry Systems



LNRE1SS



LNAE-100



LNRE2SS

LNRE1SS	Slim stainless steel gate entry system w/ keypad, telephone entry, RF receiver	774.38
LNRE2SS	Stainless steel gate entry system w/ keypad, telephone entry, RF receiver	774.38
LNACT-31B	One-button key ring transmitter for above access systems - minimum order 10	12.68
LNCCM-2A	Optional color camera for RE2	231.06
LNAK21W	Exterior digital access keypad, flush J-box mount	104.92
LNGNC-1	Curb-mount gooseneck post for RE and AE	58.70
LNAK-11	Exterior digital access keypad, surface-mount	156.12
LNAE-100	Commercial telephone entry, single-door, 125 residents	627.97

Driveway gate controls available. Call with your specifications for options

Telephone Entry Systems



**CVIU-0212/
CVIU-6212**



**CVDP-0212/
CVDP-6212**

CVIU-0**2	Single-gang mount door station (2 3/4 x 4 1/2")	95.92
CVIU-6**2	Same as above with color camera (3.8mm, 380 lines of resolution)	187.35
CVDP-0**2	Door station with mounting box (4 3/8" x 6 1/2")	144.88
CVDP-6**2	Same as above with color camera	236.27
CVDS3-0**2	Three-gang door station with access keypad (7 1/4" x 5")	174.86
CVDS3-6**2	Same as above with color camera	249.80
CVP-0920	Single door telephone entry controller (2-door model also available)	178.86
CVP-0925	Paging module (enables paging from CVP-0920 through audio system)	24.98
CVTE-0212	Telephone entry kit; includes: (1) P-0920 & (1) IU-0212 white front door intercom unit	266.19
CVTE-0282	Telephone entry kit; includes: (1) P-0920 & (1) IU-0282 black front door intercom unit	266.19
CVTE110DS	Door strike controller, required to operate a door strike	34.97

** - Available in - 21-White, 22-Brass, 23-Atq. Brass, 24-Chrome, 25-Oil Rubbed Bronze, 26-Atq. Copper, 27-Satin Silver, 28-Black, 30-Satin Nickel

**There are different models to interface with a phone system.
Please see NEC compatible models on page 152**



**CVDS3-0212
CVDS3-6212**



EFEC301

The EverAccess controllers offer integrated keypads for system management, real-time communication with a system PC and anti-passback capabilities. EverAccess controllers can operate as a stand-alone unit or networked solutions, storing up to 16,000 events. Indoor rated, not for outdoor applications.

EFEB910R	NAV Series TCP/IP Standalone Network Fingerprint Access Controller	868.06
EFEC301	NAV Series TCP/IP Standalone Network Access Controller	468.38



EFEB910R

Multi-Door Access System

The NAV access systems install much like the traditional access system, with the added benefit of networkable controllers. Each of the NAV02 and NAV04 kits can be upgraded to 8 doors. Up to 127 controllers can be combined into one system. Alarm Modules can assist with integration into security and automation systems. Kits include: Management Software, a 2- or 4-door access controller, a metal enclosure, 2 or 4 proximity readers, a USB system reader and 24 Prox cards.

EFNAV021A	2-Door FlexPack Access Control System Kit with 2 Mullion Readers	874.30
EFNAV021B	2-Door FlexPack Access Control System Kit with 2 Single-Gang Readers	874.30
EFNAV021C	2-Door FlexPack Access Control System Kit with 1 Single-Gang Reader and 1 Keypad Reader	893.04
EFNAV041A	4-Door FlexPack Access Control System Kit with 4 Mullion Readers	1124.10
EFNAV041B	4-Door FlexPack Access Control System Kit with 4 Single-Gang Readers	1124.10
EFNAV041C	4-Door FlexPack Access Control System Kit w/ 2 Single-Gang Readers and 2 Keypad Readers	1155.32
EFNAV041D	4-Door FlexPack Access Control System Kit w/ 2 Single-Gang Readers and 2 Mullion Readers	1124.10
EFNAV041E	4-Door FlexPack Access Control System Kit w/ 2 Mullion Readers and 2 Keypad Readers	1155.32
EFEFMAL1A	Alarm expansion module for use with EverAccess controller, 8 alarm inputs, 8 alarm outputs	156.12
EFEFMDR1A	2-Door expansion module for use with EverAccess controller, 2 door inputs, 2 alarm outputs	156.12
EFERR871NRB	ID Card Reader, output Wiegand 26 or RS232	49.96
EFEC301	Keyboard with ID Card Reader, output Wiegand 26 or RS232	468.38
EFERM871MRB	Mullion-Mount ID Card Reader, output Wiegand 26 or RS232	49.96
EFERS871NRB	USB Desktop ID Card Reader, for easy card programming	68.70



EFERM871 EFERR871



EFERL871

Give us a call to learn about DVR integration. Have your surveillance video tagged and searchable by card swipe!

Management Software and Cards

EFEFS10161A	Flex Series Access Control Management Software	124.90
EFEC100W26	ID Card - Thin Proximity Cards (suitable for printing)	2.50
EFEC200W26	ID Card - Thick Proximity Cards (not suitable for printing)	2.50
EFEAK110W26	ID Card - KeyFob - 125 KHz	5.00



EFEAC100W26 EFEAC200W6 EFEAK110W26

Mifare/Felica Card Readers are available, call for assistance.



ALARM CONTROLS CORP.

Locks and Release Devices

Magnetic Locks

Electromagnetic locks, commonly called "mag-locks," use a powerful magnet to hold the door shut. The door is released when power is removed. Electromagnetic locks are "fail-safe devices." They can be controlled by access, telephone and intercom systems. Depending on output of the system, a relay may be required.



ACS600S	Electromagnetic lock with 600 lbs. holding force, 12/24VDC, 400mA @ 12VDC, good for interior doors, UL listed	94.92
ACS1200S	Electromagnetic lock with 1200 lbs. holding force. 12/24VDC, 400mA @ 12VDC, good for exterior doors, UL listed	119.90
ACS1200D	Double electromagnetic lock with 1200 lbs. holding force. 12/24VDC, 400mA @ 12VDC, good for double doors, UL listed	247.30
ACS1200WP	Weatherproof lock with 1200 lbs. holding force. 12/24VDC, 400mA @ 12VDC, good for gates	164.87

Also available in Dark Bronze finish, call for part numbers. Additional mounting plates available for difficult installs.

Door Release Devices



ACSREX-100

ACSREB-1



ACSTS-2

ACSEB-1	Red Mushroom request-to exit button NO/NC	49.96
ACSTS-2	Request-to exit, 2" green, illuminated LED button on single gang plate, SPDT	29.35
ACSTS-18	Under counter door release switch	19.36
ACSREB-1	Push-to-exit bar for 36" door	86.18
ACSREX-100	Request-to-exit motion detector	68.70

Locking Devices

Lock Types: "Fail-secure" means that the lock will continue to hold when power is lost, providing a secure perimeter. "Fail-safe" means that a lock will release when power is lost to allow easy exit in case of emergency.

Door strikes are used on standard doors with knob-locks. Instead of unlocking the door, the door strike releases the door latch to allow it to open. Door strikes can be either "fail-safe" or "fail-secure."

Electromagnetic locks, commonly called "mag-locks," use a powerful magnet to hold the door shut. The door is released when power is removed. Electromagnetic locks are "fail-safe devices."

Electric deadbolts offer the security of a deadbolt with the convenience of automation. The lock is installed in the door frame and the bolt extends into the door. Deadbolts can either be "fail-safe" or "fail-secure."



SLSK990A	Door strike, fail-secure 12VDC, 800 mA for doors with wood frames	22.04
SLSD995C	Door strike, fail-safe or fail-secure for doors with metal frames. Configure in the field. One ton jaw strength. 250mA @ 12VDC	57.45
SLSD-996CNUQ	Universal door strike, can be used in wood or metal frames, 3 faceplate styles, 280mA @ 12VDC	74.94
SLE941SA600	Electromagnetic lock with 600 lbs. holding force, 12/24VDC, 500mA @ 12VDC, good for medium security doors	68.70
SLE941SA1200	Electromagnetic lock with 1200 lbs. holding force. 12/24VDC, 500mA @ 12VDC, good for high security doors	86.18
SLE941DA1K2P	Double electromagnetic lock with 1200 lbs. holding force. 12/24VDC, 500mA @ 12VDC, good for high security doors	201.09
SLSD-997BQ	Electric deadbolt, 5/8" bolt extension, fail safe, door position output, 12 VDC	106.16
SLSD997ADQ	Electric deadbolt, 5/8" bolt extension, fail secure, key override, door position output, 12 VDC	139.89

Call for mounting brackets and adapters to fit any style of door frame

Door Release Devices

SLSK1131-SQ	Indoor backlit keypad, 2 relays, 120 users	41.22
SLSK-1123-SQ	Rugged outdoor keypad, surface mount, 110 users, 2 relays	74.94
SLSK-1123-FQ	Outdoor keypad, 1-gang flush-mount, 110 users, 5A relay, great for outdoor access	68.70
SLSK-1323-SDQ	Sealed-housing outdoor digital access keypad, 1,010 users, 5-digit codes, 2 outputs, 2 egress inputs	73.69
SLSK-1323-SPQ	Same as above with Proximity reader	86.18
SLSD-7202GC-PEQ	Request-to exit, 2" green, illuminated button on single-gang plate, NO/NC	21.17
SLSD-927PKC-NEQ	No-touch, request to exit single-gang plate, sensing range to 4"	27.48
SLSS-075C-PE	Plastic surface-mount push-button (also good for panic)	2.19
SLSD961A36	Push-to-exit bar for 36" door, includes door cord	81.18
SLSD-969-S18	Armored door cord with steel end caps and 18" cable	12.30
SLSK-910RBQ	Wireless 1-channel receiver w/ relay, use to release lock with transmitter	25.60
SLSK919TT1SBU	Wireless 1-channel transmitter - keyfob	14.36
SLSK919TDWSBU	Wire-in 1-channel RF transmitter - release lock from automation system without running a new wire	12.49
SLEAP-5D1Q	5A Power Supply Charger for Access Control	136.14



CCTV

SLEV-122C-FVB3Q	Low-Profile Dome Camera, 480 TVL, 3.6mm Lens(White)	68.70
SLEV-6640-N3WQ	Low-Profile Dome Camera, 600 TVL, 3.6mm Lens(White)	81.18
SLEV-1606-N3SQ	24 IR LED Bullet Cameras, 3.6mm lens, 540 TV lines	68.70
SLEV-2706-N3GQ	Ball-Mount Color Dome 3.6mm, 600TVL, Gray	85.56
SLEV-5105-N1SQ	Single-Gang Wallplate Camera, 1.5mm lens, 170 degree	123.65
SLEVA-F5521-3	Female DC power adapter cord (Camera end of power cable)	0.94
SLVC-1BAQ	BNC-to-VGA converter, allows you to use VGA monitors	73.69
SLVG-1C12BQ	In-line BNC surge protector for CCTV equipment	19.61

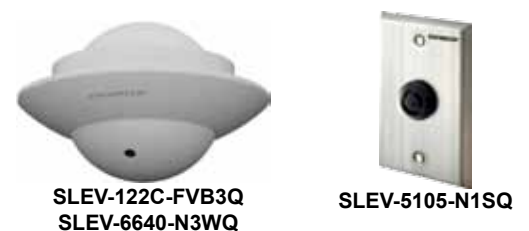

Other Related Products

Seco-Larm offers a variety of audio/video and security-related products. Unfortunately, we cannot cover them all on one page. If you are looking for a particular product for an application, please ask. Below are samples of other popular products.

SLE-37EV	3-Zone alarm pager system. Includes E-37RV vibrating receiver. (Not compatible with E-35EV or E-35RV.)	86.18
SLE-37RV	Spare receiver for use with E-37EV with built-in audible or vibrating function for silent paging.	56.20
SLE931CS22RRC	Reflective Beam Sensor with chime, use for garage or storefront to notify that someone came in	56.20
SLE-964-Q165Q	Outdoor Photobeam Detectors 50 meters with Laser Beam Alignment	236.06
SLSS-074	Double-Button Momentary Hold-Up Button. N.O. (push-to-close) momentary contact	5.93



IP Surveillance

EverFocus offers a full line of IP CCTV gear from cameras and recorders to managed PoE switches. IP CCTV provides an all-network infrastructure and very high resolution recording for outstanding detail on playback.



Page 115

Intensifier

See in low light in color without LEDs! The advanced Noise Reduction circuitry in the Intensifier camera coupled with the virtual 3D filter that is built into the DSP will allow your DVR to have 30% better compression.



Page 110-111

IP Cameras and Recorders

Toshiba offers three IP camera models with IR illuminators for zero-light viewing. They also offer very cost-effective NVRs and feature-packed hybrid NVRs. Hybrids allow installers to use existing analog cameras and add IP cameras.



Page 117

Baluns

Baluns allow you to run CCTV video signals and power over cost-effective and time saving Cat 5e cable rather than coax. The cost that they add to a job is more than recovered in the time saved in cable termination.



Page 116



Bullet Cameras

Generally meant for outdoor use, bullet cameras allow for a greater range of lenses to fit your situation. Most models also include a sun screen to stop glare.

See page 109-111 for Speco Technologies, 112-115 for EverFocus.



Dome Cameras

When using cameras indoors, most homeowners prefer the look of a dome camera to that of a bullet. Dome cameras come in surface or flush mount versions and can have fixed or vari-focal lenses. Weatherproof domes can be mounted outside under overhangs and mounts are available if an overhang is not. Dome cameras may also have color choices.

See page 109-111 for Speco Technologies, 112-115 for EverFocus.

We Are Your CCTV Experts

Worthington's Technical Sales staff has years of experience laying out CCTV systems for both residential and commercial applications. Our selection of products from Speco, EverFocus and more let us build you a solution for any job. From economical to full-featured, we can help you land that job.

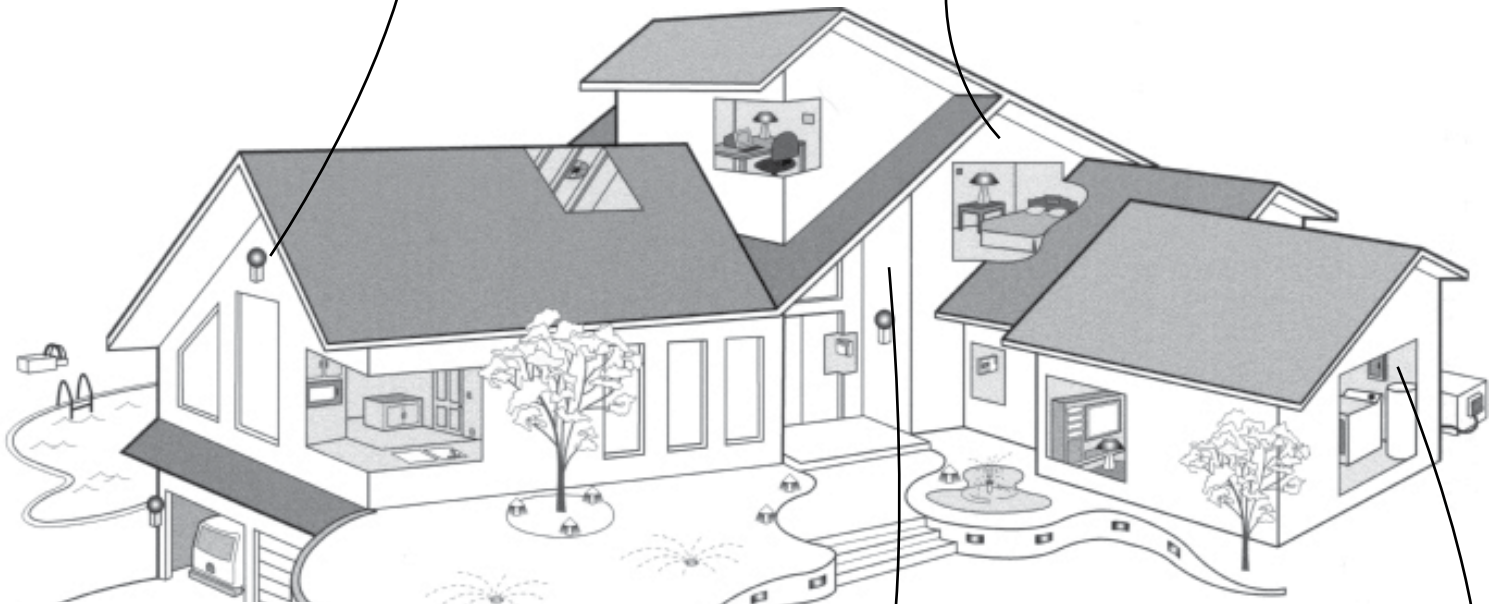

Door Cameras

A good selling feature for adding security cameras to a residential install is the ability to see who is at the door before you answer it. Door cameras give peace of mind to spouses who are home alone, allow them to avoid unwanted guests, and are a good crime deterrent as well.

See page 109-111 for Speco Technologies, 112-115 for EverFocus.



DVR

A DVR is a good way to keep track of the activity that occurs inside or outside of a residence and can help aid police by providing evidence.

See page 109-111 for Speco Technologies, 112-115 for EverFocus.



Touchscreen Integration

DVR's typically are designed for standalone operation.

Remote access is typically through a web browser or custom applications for cell phones. Look to EverFocus for integration with HAI via refreshing JPEG images, page 58-59.

New DVR Family

Speco's new lineup of DVRs is designed for the professional installer. Each model builds on the features of the model below it, and offers great up-sell opportunities. Here are some of the features that all the DVRs on this page have in common.

Free DDNS: This allows the user to access the DVR remotely without having a static IP address. It is a free service hosted by Speco.

iPhone, Android, and Blackberry: Give your customers access to their video from anywhere. They can even search and view recorded video on the iPhone app.

New Remote Maintenance: Users can now change passwords and update firmware without having to be physically at the DVR.

H.264 Compression: All Speco DVRs use the latest H.264 video compression.

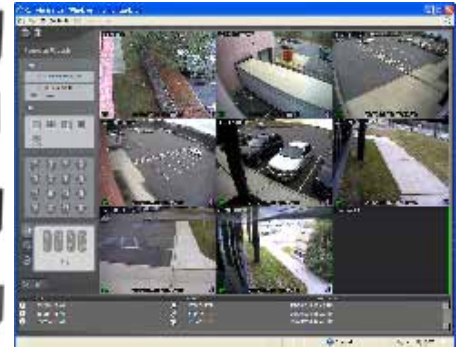

CS/LS/PS/GS Web Interface

RS/WRS Series

STD4RS500	4-channel, 500GB, desktop	353.72
STD4WRS500	4-channel, 500GB, wall mount	353.72
STD4WRSP500	4-channel, 500GB, wall mount, integrated 12VDC 5A power supply	419.41
STD8RS500	8-channel, 500GB, desktop	537.82
STD8WRS500	8-channel, 500GB, wall mount	537.82
STD16RS1TB	16-channel, 1TB, desktop	612.76
STD16WRS1TB	16-channel, 1TB, wall mount	612.76



This series is built for low-budget or entry level CCTV jobs. It is your best bet to combat the packages the big box stores offer.

EZ Record, copy, and setup, H.264 compression, 120 FPS, web-based remote access, free DDNS, 1 audio channel for each camera, VGA output, hard drives available to 2TB.

The STD4WRSP250 features an integrated 12VD/5A power supply. This allows installers to run all wires to one compact enclosure.



CS/WCS Series

STD4CS500	4-channel, 500GB, desktop	492.98
STD4WCS500	4-channel, 500GB, wall mount	492.98
STD8CS500	8-channel, 500GB, desktop	624.50
STD8WCS500	8-channel, 500GB, wall mount	624.50
STD16CS1TB	16-channel, 1TB, desktop	795.49
STD16WCS1TB	16-channel, 1TB, wall mount	795.49



CS DVRs pick up where RS leaves off. They are designed for rapid installations using intuitive setup wizards. CS has all the features of RS plus an enhanced user interface and Museum Search, searches for motion in a user-defined area.

CS can also email the installer important notifications like device health and hard drive status at pre-determined intervals. Record rates are up to 480FPS and hard drives are available to 2TB.



LS Series

STD8LS500	8-channel, 500GB, desktop	1018.93
STD16LS1TB	16-channel, 1TB, desktop	1287.22



LS DVRs include all the features CS has and also uses the same user interface. It adds looping outputs for each camera, DVD burner, SATA port, and two-way audio. Hard drives are available to 6TB.

PS / GS Series

STD24PS1TB	PS 24-channel (8 analog + 16 IP)	1798.56
STD32PS2TB	PS 32-channel (16 analog + 16 IP)	2061.60
STD24GS1TB	GS 24-channel (8 analog + 16 IP)	2524.23
STD32GS2TB	GS 32-channel (16 analog + 16 IP)	2787.27



PS and GS DVRs use the same interface as CS and LS and add hybrid IP functionality. They can record Speco's ONSiP and ONViF cameras at up to 2MP. Hard drives are available up to 6TB on PS and 8TB on GS.

PS records up to 480FPS @ CIF resolution and GS records up to 480FPS @ full D1.

LS and PS Wall Mount Kit

STLSPSWMKIT	Wall mount kit for LS and PS series DVRs, mounts DVR to wall or to the front of 19" rack rails, also has VESA 75 and 100 pattern for mounting a monitor	47.96
-------------	---	-------



ONSIP NVR



Speco's NVR is a great way to get into the growing IP CCTV business. It can record 4 IP cameras at up to 2.3 MP on the first 3 channels. It can be viewed using iPhone and Android apps. It can also archive to the cloud for enhanced recording capacity and security. Use the NVRP4 with Specos IP cameras found on page 110.

STNVRP41TB	Records 4 IP cameras, supports H.264/MPEG4/MJPEG, 1TB, great for ONSIP cameras	787.62
------------	--	--------

Intensifier 3

Intensifier 3 brings new features to the already popular Intensifier series cameras. Light amplification has been increased to 512x ambient and resolution has been increased to 650 lines. This provides an excellent quality color picture even in near zero light conditions. Presets have also been added to ease installation. Simply go into the on-screen menu and select your application and the camera is configured.



Camera Type	Weatherproof Color Dome	Indoor Color Dome	Weatherproof Color Dome	Weatherproof Color Dome	Weatherproof Color Bullet	Indoor Color Dome	Weatherproof Color Bullet
Low-Light Technology	Intensifier 3	Intensifier 3	Intensifier 3	Intensifier 3	Intensifier 3	65' IR	150' IR
Resolution	650 lines	650 lines	650 lines	650 lines	650 lines	540 lines	540 lines
Lens	3.6mm	2.8-12mm Auto-iris	2.8-12mm Auto-Iris	2.8-12mm Auto-Iris	2.8-12mm Auto-Iris	2.8-11mm Auto-Iris	2.8-12mm Auto-Iris
Concealed Cable	Yes	Yes	Yes	Yes	Yes	Yes	Yes
Power	12VDC 230mA	12VDC 230mA	12VDC 230mA	12VDC 230mA	12VDC 230mA	12VDC 380mA	12VDC or 24VAC 450mA
Size (inches)	4 Dia. x 2.5 H	5.5 Dia. x 4.5 H	6.3 Dia. x 3.9 H	5.5 W x 4.4 H x 5.5 D	3.9 W x 4.9 H x 8.2 L	5 Dia. x 3 H	3.5 W x 4.5 H x 9.7 D
Part Number	STHINT13D7G	STCVC6246IHR	STHT7246IHR	STHTINTD8 - Black STHTINTD8W- White	STHTINTB8	STCVC648IRV FHQ	STCVC627V FSCS
Price	180.11	200.84	241.93	272.78	266.54	168.99	233.44

Professional IR

Professional IR cameras are still the best choice in zero-light conditions. They feature enhancements to prohibit IR from reflecting from the lens into your image.

PIR Cameras

Nothing deters crime in the dark better than light. Speco's PIR cameras have integrated bright white LEDs. When they detect motion the lights turn on, prompting the perpetrator to turn toward the light, and allowing the DVR to get an image of their face. These cameras let you offer your customers a solution that not only records crime, but can help prevent it.



STCVC5300DPVF	Weatherproof PIR Dome, 600 Line Res, 2.8-12mm lens, 65' IR, 20' illumination	274.78
STCVC5100BPVF	Weatherproof PIR Bullet, 600 Line Res, 2.8-12mm lens, 65' IR, 20' illumination	274.78

Extreme IR Cameras

If you need crisp images in complete darkness, look at Extreme IR. These cameras feature new IR illumination technology that eliminates ghosting that occurs on other IR cameras.



STHT7048IRVF	Weatherproof Bullet w/ External IRs, 600 Line Res, 2.8-12mm lens, up to 196' IR range	452.89
STVL7038IRVF	Weatherproof Bullet w/ Internal IRs, 600 Line Res, 2.8-12mm lens, up to 131' IR range	286.52

License Plate Recognition

Speco's license plate camera is designed specifically for viewing and recording license plates. When a car drives past, the plate comes into view and the rest of the scene is black. This camera should be placed 10' - 30' from the plates, and can capture vehicles moving up to 55 MPH.



STCLPR66B4B	License Plate Bullet Camera, 600 line res, 9-22mm lens, 12VDC/24VAC	310.63
-------------	---	--------

ONSIP IP Cameras

ONSIP is Speco's latest line of IP cameras. They are compatible with the ONVIF industry standard, viewable on iPhone and Android, and include free DDNS. ONSIP cameras can be recorded on the NVR shown below, or on PS, GS, or PC16T DVRs.



STO2D3	2 MP Weatherproof Dome, 3.6-16mm lens, 49' IR, Micro SD Slot, 2-Way Audio, PoE	485.11
STO2DP7	2 MP Indoor Dome, 3.6-16mm lens, 49' IR, Micro SD Slot, 2-Way Audio, PoE	458.88
STO2S1	2 MP Indoor Wall Pan/Tilt Cam, 2.8-12mm lens, 49' IR, Micro SD Slot, 2-Way Audio, PoE	524.58
STOIPC72B7G	D1 (704x480) Outdoor Bullet, 4.3mm lens, 12VDC	243.93
STOIPC22T7G	D1 (704x480) Outdoor Turret, 4.3mm lens, 12VDC	239.31
STOIPC21T7B	D1 (704x480) Indoor Turret, 4.3mm lens, 12VDC	230.07
STOPTZ36XO	530 Line Outdoor PTZ Dome, 3.4-122.4mm (36X), Micro SD Slot, 2-Way Audio, 24VAC/1.8A	1839.28

ONSIP NVR

STNVRP41TB	Records 4 IP cameras, supports H.264/MPEG4/ MJPEG, 1TB, great for ONSIP cameras	787.62
------------	---	--------



New Value Line IR

Value Line IR cameras are your go-to choices when working on a low-budget job. They still have features like varifocal lenses and IR separators, but come in at a very reasonable cost and have Speco quality behind them. Value Line cameras are also often used with HAI video touchscreen systems.



Weatherproof Bullet	Weatherproof Bullet	Weatherproof Dome	Weatherproof Dome
65' IR	98' IR	65' IR	98' IR
480 lines	480 lines	480 lines	480 lines
3.6mm	4-9mm	3.6mm	4-9mm
Yes	Yes	Yes	Yes
12VDC 300mA	12VDC 360mA	12VDC 300mA	12VDC 400mA
6.7 L x 2.75 W x 2.5 H	9.0 L x 3.8 W x 3.3 H	3.6 Dia x 3.2	4.5 Dia x 4.25
STVLED70B7G	STVLED71B3G	STVLED23T7G	STVLED24T3G
52.83	77.06	49.46	73.69

Focus-Free Intensifier

Have you ever had to return to a job after completion to re-focus a camera? Focus Free Intensifier (FFI) cameras eliminate those trips. FFI models feature auto-focus lenses that constantly correct the focus to keep the scene looking clear.



See page 112 for CCTV power supplies.

Weatherproof Dome	Weatherproof Camera	Weatherproof Bullet	Camera Type
Intensifier 3	Intensifier 3	Intensifier 3	Low-Light Technology
580 lines	580 lines	580 lines	Resolution
2.8-10mm Auto-Focus	2.8-10mm Auto-Focus	2.8-10mm Auto-Focus	Lens
Yes	Yes	Yes	Concealed Cable
12VDC or 24VAC 230mA	12VDC or 24VAC 230mA	12VDC or 24VAC 300mA	Power
6.29 Dia x 3.89 H	6.29 W x 3.89 H	10.5 L x 3.25 W x 3.5 H	Size (inches)
STHTD8FFI	STHT7248FFI	STHTB11FFI	Part Number
322.12	314.87	337.23	Price

Miniature Cameras

STCVC61HR*	Miniature Color Camera, 1.9" diameter, Weatherproof, Vandal Resistant, 540 lines, 3mm Fixed Lens, *Black or White	88.18
STCVC71HR*	Miniature Color Camera, 10 IR LEDs, 1.9" diameter, Weatherproof, 540 lines, 3.4mm Fixed Lens, *Black or White	103.79
STCVC61ILT*	Miniature Color Camera, 1.9" diameter, Weatherproof, Basic Intensifier, 600 lines, 3mm Fixed Lens, *Black or White	98.67



Speco's mini cameras are a great companion to the RS DVRs found on the next page. Both offer entry-level features and pricing to help you be competitive when bidding against big-box store CCTV kits.

Installation Aids

STVMS2	Portable battery-powered test monitor, 4" display, perfect for installers, carrying case	277.90
STVIDCAT2	Cat5 video balun pair, integrated power connectors, video and power 900' over Cat5	40.72



STVIDCAT2



STVMS2

Altronix Power Supplies for Cameras

ALTV615DC48ULM3	12VDC, 4A, 8 fused outputs	91.80
ALTV615DC616UL	12VDC, 6A, 16 fused outputs	137.39
ALTSAV4D	12VDC, 5A, 4 PTC protected outputs	51.33
ALTV248	24VAC, 4 Amp, 8 fused outputs	60.71

960H - 700 Line Resolution Cameras and Recording

New 960H Equipment - Record at 700 Lines of Resolution!

About 960H: Until now, traditional DVRs recorded video at a maximum resolution of D1, or 540 horizontal lines. New camera chipsets have increased to 650 lines, but DVRs have always throttled that back. 960H changes all of that. It's a new video standard that Speco is using in both cameras and DVRs that offers 700 lines of resolution. 960H is still an analog signal that uses economical coax cabling, yet it provides near DVD quality, and a very noticeable improvement over 540 line resolution.

Does my system have to be all 960H? No. Just as we have mixed higher and lower resolution cameras with D1 DVRs in the past, the same is possible with 960H - it's still analog composite video. Mix 960H and lower resolution cameras with a traditional D1 DVR, but viewing and recording will be limited to 540 lines by the D1 DVR. Mix 960H and lower resolution cameras on a 960H DVR, and benefit from the full resolution of your 960H cameras.



STD16DS1TB



STHTINTD8H



STHTINTB8H



STHT7246H

STD16DS1TB	16-channel 960H DVR, 1TB hard drive, records at up to 700 lines of resolution, includes free DDNS service, iPhone and Android apps, thumbnail search to easily narrow down time of event, EZ Copy records what you watch to a USB memory drive	756.02
STHTINTD8H	Intensifier 3 Weatherproof Turret Camera, 960H 700 line res, 2.8-12mm lens, 12VDC/24VAC	287.27
STHTINTB8H	Intensifier 3 Weatherproof Bullet Camera, 960H 700 line res, 2.8-12mm lens, 12VDC/24VAC	291.89
STHT7246H	Intensifier 3 Weatherproof Vandalproof Dome Camera, 960H 700 line res, 2.8-12mm lens, 12VDC/24VAC	252.42

Infrared (IR)

IR cameras are the workhorse of zero-light CCTV. Select cameras based on the distance your application requires. Also be aware of power consumption with IR cameras. The power figures listed below are max-draw scenario with IR illuminators and heater (select models) on.

Indoor Domes

This is a series of cost-effective cameras for indoor use. They are a great choice when IR illumination is not required. Call for color options.

Call for color and lens options!



Camera Type	Weatherproof Color Bullet	Weatherproof Color Dome	Weatherproof Color Bullet	Weatherproof Color Dome	Indoor Color Dome	Indoor Color Dome	Indoor 3-Camera Color Dome
Low-Light Technology	261' IR	100' IR	80' IR	80' IR	No	No	No
Resolution	720 lines	550 lines	540 lines	540 lines	520 lines	540 lines	560 lines
Lens	6-50mm Auto-Iris	2.6-11mm Auto-Iris	4.3mm	3.7-12mm Auto-Iris	3.7-12mm	3.5-8.5mm Auto-iris	(2) 2.4mm (1) 12mm
Concealed Cable	Yes	Yes	No	Yes	Yes	Yes	Yes
Power	24VAC 19.3W	12VDC/24VAC 8.76W/12W	12VDC 3.6W	12VDC 3.4W	12VDC/24VAC 2.5W/4.5W	12VDC 2.4W	12VDC 20mA
Special	Heater, -40° F Operating Temp	Heater, -40° F Operating Temp	Compact Size	Vandal Resistant			3 Cameras Over A Single Coax
Size (inches)	4.5 x 10.8	5.9 Dia. x 4.5	2.9 x 4.3	5.6 Dia. x 4.55	4.2 Dia. x 3.1	5.0 Dia. x 3.46	4.0 Dia. x 3.0
Part Number	EFEZ765	EFEHD730	EFECD360	EFEHD362	EFED300NB	EFECD360	EFE3D2412MPXW
Price	373.45	224.82	61.20	156.12	106.16	93.68	248.55

ECOR264 X1 Series DVRs



ECOR264 X1 series DVRs offer H.264 compression format for efficient disk storage and network bandwidth conservation. The ECOR264 X1 series also supports GUI menu, HTTP streaming for live mobile monitoring, smart & snapshot search, express configurations, etc. Available in 4, 9 or 16-channels with built-in DVD burner. iPhone app available for viewing.

EFECOR2649X1T	9-channel, 1TB, 270 FPS, DVD burner	686.95
EFECOR26416X12T	16-channel, 2TB, 480 FPS, DVD burner	967.98

Storage options ranging from 500GB to 2TB on all models. Call for specific pricing.

Altronix CCTV Power Supplies

ALTV615DC48ULM3	12VDC, 4A, 8 fused outputs	91.80
ALTV615DC616UL	12VDC, 6A, 16 fused outputs	137.39
ALTSAV4D	12VDC, 5A, 4 PTC protected outputs	51.33
ALTV248	24VAC, 4 Amp, 8 fused outputs	60.71

MuxLab Baluns - Wire Smarter

Wiring with baluns not only allows longer wire runs, it also speeds pre-wire jobs up. Cat 5 can be terminated faster than coax and typically pulls faster. MuxLab also offers head-end products that make installs cleaner. See Page 116.



ECOR Series DVRs



ECOR series compact size DVRs are equipped with simple Graphical User Interface (GUI) for quick and easy menu configuration. MPEG4/H.264 and up to 240 FPS of real time recording & playback. Available in 4 or 8 channel, with or without DVD burner.

EFECOR2644D2500	4-channel, 500GB, 120 FPS, DVD burner	312.25
EFECOR2648D21T	8-channel, 1TB, 240 FPS, DVD burner	562.05
EFECOR2644F2500	4-channel, 500GB, D1 60 FPS	281.02
EFECOR2644F2500	4-channel, 500GB, D1 120 FPS	281.02

Storage options ranging from 500GB to 2TB on all models. Call for specific pricing.

Endeavor Series DVRs



Endeavor series DVRs are great for higher-end applications or where fluid motion playback is important. It features 400 FPS at D1 resolution. An HDMI output also helps provide clear playback on large monitors.

EFENDEAVORX42	16-channel, 2TB, 400 FPS, DVD burner, HDMI output	1623.70
---------------	---	---------

Storage options ranging from 500GB to 4TB on all models. Call for specific pricing.

Ultra Series - 720 Line Resolution - 960H

The Ultra series boasts cameras that are 720+ TVL. All Ultra series cameras contain the Polestar II feature that allow the camera to provide a color picture without IR in near zero light. Many offer True Day/Night with DWDR (Digital Wide-Dynamic Range) and OSD (On Screen Display) menu which provides a whole range of additional features and configurations to give you the best possible image! Higher resolution cameras mean your customers get better detail when reviewing video on their DVRs.



See page 112 for CCTV power supplies.

Weatherproof Color Ball	Weatherproof Color Ball	Indoor Color Dome	Indoor Color Dome	Outdoor Color Dome	Outdoor Color Dome	Outdoor Color Bullet	Camera Type
50' IR	65' IR	No	100' IR	No	100' IR	165' IR	Low-Light Technology
700 lines	700 lines	700 lines	700 lines	700 lines	700 lines	700 lines	Resolution
3.6mm Auto-iris	2.8-10.5mm Auto-iris	2.8-12mm Auto-iris	2.8-12mm Auto-iris	2.8-12mm Auto-iris	2.8-12mm Auto-iris	2.8-12mm Auto-iris	Lens
Yes	Yes	Yes	Yes	Yes	Yes	Yes	Concealed Cable
12VDC 310mA	12VDC 350mA	12VDC/24VAC 2.16W/2.9W	12VDC/24VAC	12VDC/24VAC 1.9W/2.2W	12VDC/24VAC 5.2W/5.5W	12VDC/24VAC 1.1A/875mA	Power
Vertical/Horizontal Mounting	Vertical/Horizontal Mounting	* B-Black, W-White	* B-Black, W-White	Heater, -40° F Operating Temp	Heater, -40° F Operating Temp	Heater, -40° F Operating Temp	Special
3.6 Dia. x 2.5	4.7 Dia. x 3.3	5.37 Dia. x 3.75	5.37 Dia. x 3.75	6.14 Dia. x 5.1	6.14 Dia. x 5.1	3.8 x 3.3 x 4.4	Size (inches)
EFEBD331E	EFEBD431E	EFED710*	EFED730*	EFEHD700	EFEHD730	EFEZ750*	Part Number
86.18	118.66	156.12	181.10	212.33	224.82	286.02	Price

License Plate Recognition

The license plate camera is designed specifically for viewing and recording license plates. When a car drives past, the plate comes into view and the rest of the scene is black.



EFEZPLATECAM	License Plate Bullet Camera, 600 line res, 3.5-16mm lens, 8'-60' range, capture up to 35MPH, 12VDC/24VAC	373.45
EFEZPLATECAM2	License Plate Bullet Camera, 600 line res, 5-50mm lens, 16'-90' range, capture up to 75MPH, 12VDC/24VAC	623.25

PTZ

EFEPTZ3600	Outdoor PTZ Camera, 530 line res, 36x optical zoom, 3.4-122.4mm, 24VAC, -40° F Operating Temp	1498.80
EFEPTZ3100I	Indoor PTZ Camera, 520 line res, 30x optical zoom, 3.3-99mm, 24VAC, -14° F Operating Temp	1061.65
EFEKB500	Multi-Function Keyboard/Joystick Controller, handles up to 999 cameras	405.92



EFEPTZ3600



EFEKB500



EFEPTZ3100I



Use with the 720 line cameras at the top of this page for best performance!

700 Line 960H DVRs

New 960H Equipment - Record at 700 Lines of Resolution!

About 960H: Until now, traditional DVRs recorded video at a maximum resolution of D1, or 540 horizontal lines. New camera chipsets have increased to 650 lines, but DVRs have always throttled that back. 960H changes all of that. It's a new video standard that EverFocus is using in both cameras and DVRs that offers 700 lines of resolution. 960H is still an analog signal that uses economical coax cabling, yet it provides near DVD quality, and a very noticeable improvement over 540 line resolution.

Does my system have to be all 960H? No. Just as we have mixed higher and lower resolution cameras with D1 DVRs in the past, the same is possible with 960H - it's still analog composite video. Mix 960H and lower resolution cameras with a traditional D1 DVR, but viewing and recording will be limited to 540 lines by the D1 DVR. Mix 960H and lower resolution cameras on a 960H DVR, and benefit from the full resolution of your 960H cameras.



EFECOR960-16X1	New 960H 16-channel 700 Line Resolution DVR	TBD
EFEPARA960-16X4	New 960H 16-channel 700 Line Resolution DVR	TBD

HDcctv Explained

HDcctv from Everfocus is a standard for transmitting high definition video over a single coax cable - even RG-59. It gives you the ability to offer Megapixel-quality video without the expense and effort required to make a full IP-type system operate well. Everfocus also offers hybrid DVRs that will accept up to 4 standard camera inputs and 4 HDcctv camera inputs. This provides the most cost-effective solution; high definition cameras where needed and lower-cost standard cameras in less sensitive areas.

The end-user experience of HDcctv is truly impressive. For example, imagine a camera pointing at a group of registers. When the manager suspects theft, he can use a mouse to draw a square on the area to zoom in on. When the DVR zooms, there is no noticeable loss in quality. This is because HD DVRs record lossless - full framerate and uncompressed.



Standard CCTV

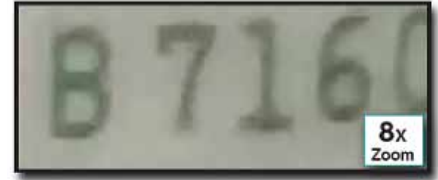

HDcctv

HDcctv Cameras

See page 89 for CCTV power supplies.



Camera Type	Indoor Dome	Indoor Dome	Weatherproof Ball	Weatherproof Color Dome	Weatherproof Color Dome	Outdoor Wedge	Weatherproof Color Bullet
Low-Light	65' IR	No	60' IR	No	100' IR	No	150' IR
Resolution	1080 (2.1MP)	1080 (2.1MP)	1080 (2.1MP)	1080 (2.1MP)	1080 (2.1MP)	1080 (2.1MP)	1080 (2.1MP)
Lens	3.3-12mm Auto-iris	3.8-16mm	3.6mm	3.3-12mm Auto-iris	3-9mm Auto-iris	3.6mm	3-9mm Auto-iris
Concealed Cable	Yes	Yes	Yes	Yes	Yes	Yes	Yes
Power	12VDC/24VAC 616mA/471mA	12VDC/24VAC 275mA/230mA	12VDC 390mA	12VDC/24VAC 275mA/230mA	12VDC/24VAC 800mA/416mA	12VDC/24VAC 275mA/230mA	12VDC/24VAC 1.1A/500mA
Special	Flush/Surface Mounting	Best Value	Motorized IR Cut Filter	Vandal Resistant	Vandal Resistant	Triangular Shape	External Zoom Adjustments
Size (inches)	5.5 Dia. x 5.1		3.6 Dia. x 3	4.8 Dia. x 4.2	5.94 Dia. x 4.86	5.47 x 5.28 x 1.93	3.9 Dia. x 7.7
Part Number	EFEDH5240	EFEDH5210	EFEBH5241	EFEHH5200	EFEHH5241	EFEHH5205	EFEZH5241
Price	312.25	281.02	248.55	293.52	512.09	312.25	468.38

HDcctv DVRs

All HDcctv DVRs feature HDMI output and USB/DVD video export.

EFEPHD042	4 HD Channels, 2TB, small form factor, H.264, expand storage using eSata, advanced search, 4 and 6TB available	686.95
EFEDRHD2H142	2HD/14 Standard Channels, 2TB, H.264, expand storage using eSata, advanced search, 4 and 6TB available	749.40
EFEDRHD4H44	4HD/4 Standard Channels, 4TB, H.264, expand storage using eSata, advanced search, 8TB available	999.20
EFEPHD084	8HD Channels, 4TB, H.264, expand storage using eSata, advanced search, 8TB available	2017.14



EFEDRHD2H142TB

- Choice of 1080p or 720p HDcctv camera support for superlative image clarity
- MobileFocus: Supports iPhone®/iPad®/Android™/Blackberry®
- Virtual Real Time Recording: 15 FPS @ 1080p, 30 FPS @ 720
- Dual Stream Controls: Record at a higher resolution but view at a lower resolution online/mobile device for faster viewing
- 2x, 4x, 8x, 16x zoom on local and remote live & playback
- Independent Channel Controls: Frame Rate/Record Quality
- Recording rate can be changed at different times of the day via scheduling
- Simultaneous Pentaplex Operation at DVR & Online
- FREE DDNS Service Hosted by EverFocus for EASY Networking Options
- Main Monitor: Simultaneous Viewing at 1080 x 1080 on HDMI and VGA
- Per-Camera Audio Channels
- Multiple Control Inputs: mouse/front panel/IR remote/EKB500 keyboard
- Smart Search: quickly identify motion in areas of interest from recorded video
- Event Search: Search date/time by an event (alarm, motion, video loss)
- Express Playback & Search: Click, Drag playback bar for Instant Viewing
- Remote Archive: from a PC copy video onto the USB/DVD in the DVR
- 3 different administration levels to control access to DVR controls
- Online Web interface: Allows 10 users to simultaneously view online from a browser
- IR Remote, USB Mouse, Rack Ears included

EverFocus IP CCTV Solution

Have you thought about moving toward IP surveillance for your CCTV jobs? Many installers have and although making the move just because it's the latest technology may not be the right reason, there are many good reasons to move to IP in certain applications.

Ease of Cabling - IP cameras use standard Cat 5e/6 cabling. Most are PoE powered, further simplifying the pre-wire.

High Resolution - IP cameras are available up to 3 megapixel resolution. When paired with a high resolution recorder, this allows the user to zoom in on playback with incredible detail.

Scalable - With NVRs available from 2 to 64 channels, you can consolidate hardware and not have to use multiple recorders on those larger jobs.

2 Megapixel IP Cameras

All cameras shown here feature **2 Megapixel** resolution (1920x1080). They have a BNC test output for image alignment and configuration. These models also include Wide Dynamic Range (WDR) to help compensate for harsh lighting. They can be powered using a 12VDC source or PoE.



EFEDN3260



EFEHN3260



EFEZN3260

EFEDN3260	Indoor Dome, 3-9mm lens, 65' IR	474.62
EFEHN3260	Outdoor Dome, 3-9mm lens, 100' IR	530.82
EFEZN3260	Outdoor Bullet, 2.8-10mm lens, 275' IR	562.05

Elite Series 2-16 Channel NVRs

The Elite series is available in 2-, 4-, 8-, and 16-channel models with up to 8TB of storage. They have 2 Gigabit Ethernet ports - one for the camera network and one for the client network for remote access and viewing. Built-in video analytics include motion, missing object, and foreign object. Installers can configure the NVR through Internet Explorer 7 or higher. Video can be exported to JPG stills AVI video.



EFNVR216

EFNVR2022T	Elite NVR, 2-channel, 2 TB	780.62
EFNVR2024T	Elite NVR, 2-channel, 4 TB	1405.12
EFNVR2042T	Elite NVR, 4-channel, 2 TB	1042.92
EFNVR2044T	Elite NVR, 4-channel, 4 TB	1542.52
EFNVR2084T	Elite NVR, 8-channel, 4 TB	1942.20
EFNVR2164T	Elite NVR, 16-channel, 4 TB	2410.57
EFNVR2168T	Elite NVR, 16-channel, 8 TB	2872.70

ENVS Series 8-32 Channel NVRs

The ENVS is available in 8-, 16-, and 32-channel models with up to 4TB of storage. Built-in video analytics include motion, missing object, and foreign object. Remote viewer software provides access to all video and menu functions. Video can be exported to JPG stills AVI video.



EFENVS800

EFENVS8002TB	ENVS NVR, 8-channel, 2 TB	2871.45
EFENVS16004TB	ENVS NVR, 16-channel, 4 TB	4240.36
EFENVS32004TB	ENVS NVR, 32-channel, 4 TB	6118.85

3 Megapixel IP Cameras

All cameras shown here feature **3 Megapixel** resolution (2048x1536). They also have a BNC test output for image alignment and configuration. They can be powered using a 12VDC source or PoE.



EFEDN3340



EFEHN3340



EFEZN3340

EFEDN3340	Indoor Dome, 3-9mm lens, 65' IR	499.60
EFEHN3340	Outdoor Dome, 3-9mm lens, 100' IR	555.80
EFEZN3340	Outdoor Bullet, 2.8-10mm lens, 275' IR	630.74

1.3 Megapixel IP Cameras

All cameras shown here feature **1.3 Megapixel** resolution (1280x1024). They have a BNC test output for image alignment and configuration. These models also include Wide Dynamic Range (WDR) to help compensate for harsh lighting. They can be powered using a 12VDC source or PoE.



EFEDN3160



EFEHN3160



EFEZN3160

EFEDN3160	Indoor Dome, 3-9mm lens, 65' IR	424.66
EFEHN3160	Outdoor Dome, 3-9mm lens, 100' IR	437.15
EFEZN3160	Outdoor Bullet, 2.8-10mm lens, 275' IR	493.36

Commander Series 64 Channel NVRs

Record 64 cameras on one NVR! The Commander is available with up to 12TB of storage and has 2 Gigabit Ethernet ports - one for the camera network and one for the client network for remote access and viewing. It can also be set up with main and sub-servers to provide 100 channels of synchronized playback.



EFNVR4000

EFNVR40004T	Commander NVR, 4-ch - expand to 64, 4 TB	2060.85
EFNVR40008T	Commander NVR, 4-ch - expand to 64, 8 TB	2560.45
EFNVR400012T	Commander NVR, 4-ch - expand to 64, 12 TB	3060.05

Networking

Quality networking devices are the backbone of an IP camera system. Choose standard or PoE switches from Everfocus and Luxul to ensure a proper network backbone for your system.

EFESM308T000D	8-port Managed Switch, PoE every port, 130W total PoE output, 30W max per port	437.15
EFESM316T002R	16-port Managed Switch, PoE every port, 180W total PoE output, 30W max per port	562.05
LUXXMS-1008P	8-port Managed Switch, PoE every port, 15.4W per port, remote reboot per port	300.70
LUXXAP-1050	802.11n Outdoor Wireless Bridge, 30W PoE pass-through	533.95



LUXXMS-1008P



LUXXAP-1050

Cat 5e CCTV Hub with Integrated Camera Power

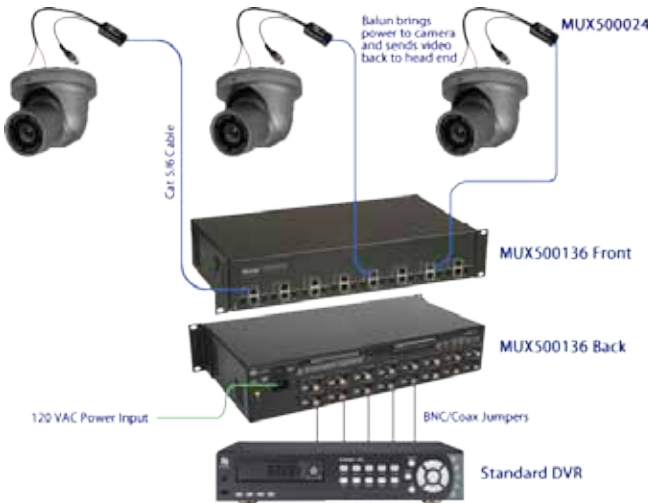

CCTV Power Integrator Hub

- Combine power and video into 1 Cat 5 run
- Powers each camera (24VAC)
- Each output individually fused
- 28VAC mode for long runs
- Use with MUX500024 baluns (see below)



Cat 5e is well-suited for CCTV wiring for two reasons: It is easy to pull and terminate; and it can carry power and video over distances with just one cable pull. Mount the Power Integrator Hub at the head end near the DVR and run Cat 5e to the cameras. Use the MUX500024 baluns at the camera to connect power and video. Patch each camera port from the Power Integrator Hub to the DVR and set the power for each camera to 24VAC or 28VAC for longer runs to account for voltage drop. Each camera output is individually fused so if one camera shorts, the rest will still operate.

MUX500136-US	CCTV Passive Power Integrator Hub	755.64
BL202356	3' RG-59 BNC Patch Cable	0.99

CCTV to Cat 5e/6 Baluns and Hubs



MUX500000	CCTV RJ45 balun-2200'	13.49
MUX500007	CCTV PTZ balun-1400', up the coax PTZ	36.53
MUX500009	CCTV screw-terminal balun-2200'	13.49
MUX500009-2PK	2-pack of above	26.98
MUX500015	CCTV long-reach active balun-5000'	171.74
MUX500022	CCTV pass-thru balun-2200', 2-wire PTZ	17.99
MUX500023	CCTV mini balun-2200', screw terminals	15.18
MUX500023-2PK	2-pack of above	30.35
MUX500024	CCTV power-thru balun-2200'	17.99
MUX500024-CNV	Same as above, converts 24VAC to 12VDC at camera side	56.20
MUX500031	CCTV RCA balun	19.67
MUX500037	CCTV Quad BNC balun	46.40
MUX500101	Active CCTV transmitter balun 24VAC-3000'	67.45
MUX500124	LongReach active balun w/ power pass through, 5,000' distance, use with MUX500009 or MUX500024 at camera	151.13
MUX500126	LongReach active balun 8-port hub w/ power pass through, 5,000' distance, use with MUX500009 or MUX500024 at camera	755.64



Cat 5e CCTV Hub - Add Your Own Power



MUX500130	Passive CCTV Hub- Video/Pwr/PTZ	294.76
BL202356	3' RG-59 BNC Patch Cable	0.99

CCTV Over IP

MUX500110	Extend 2 IP cams 650' at 100Mbps or 1 mile at 25Mbps	549.56
MUX500111	Extend 1 IP cam 1600' w/ 14 Watts of PoE	82.43



HDcctv Baluns

MUX500701	Extend HDcctv 150' over Cat 5e cable	39.34
MUX500715	Converts HDcctv to HDMI, then transmits it 330' over 1 Cat 5e, transmitter and receiver included	542.07



IP Cameras - Compatible With HAI OmniTouch 5.7e



Camera Type	Indoor Color Mini-Dome	Indoor Color Mini-Dome	Indoor Color Dome	Indoor P/T Color Dome	Weatherproof Color Dome	Weatherproof Color Bullet	Weatherproof Color Bullet
Compression	JPEG/MPEG4	JPEG/MPEG4	JPEG/MPEG4/H.264	JPEG/MPEG4	JPEG/MPEG4/H.264	JPEG/MPEG4	JPEG/MPEG4
Low-Light Technology	-	-	60' IR SRLED	-	60' IR SRLED	30' IR	75' IR
Resolution	640x480	1 Megapixel	1920x1080	1600x1200	1920x1080	640x480	1600x1200
Lens	2-4mm	3-12mm	3-9mm	3.6mm	3-9mm	2-4mm	3-9mm
Power	PoE, 12VDC	PoE, 12VDC	PoE, 12VDC	PoE, 12VDC	PoE, 12VDC	PoE, 12VDC	PoE, 12VDC
Size (inches)	5.6 Dia x 4.2 H	4.3 Dia x 3.2 H	4.3 Dia x 6.3 H	5.16 W x 5.5 D x 5.0 H	4.5 Dia x 6.8 H	7 L x 2.76 Dia	8.8 L x 3.3 Dia
Part Number	TOSIK-WD01A/3.3	TOSIK-WD04A	TOSIK-WD14A	TOSIK-WB16A Add -W for Wireless	TOSIK-WR14A	TOSIK-WB70A	TOSIK-WB80A
Price	254.34	328.34	526.42	419.96	667.20	472.00	548.90

PoE Sources

LSA90A00-1	1-port PoE Injector	51.73
LUXXMS-1008P	8-port Gigabit Ethernet PoE Smart Switch, XenSmart management, rack mountable	300.70



LUXXMS-1008P



All Toshiba IP cameras work great on the HAI OmniTouch 7 and SnapLink Mobile apps. The installer can fine-tune the image size to make it stream best on touchscreens and smart phones over the cell network.



Entry Level NVR

The 4-channel ESV4 is an embedded recorder that provides low-cost entry to the IP surveillance market with plenty of features. It has an HDMI output and 5 MP max resolution. The ESV4 can output video to AVI or MJPEG formats. Best of all there are apps available for it on iPhone, iPad, and Android!

TOESV4-1T	4-channel NVR, 1TB Hard Drive	448.88
-----------	-------------------------------	--------



Entry Level NVR

The ESV16 is a 16-channel embedded recorder with built-in analytics including object loss, tripwire, and tamper detection. It has a VGA output and customizable Google and eMap functionality. The ESV16 can output video to AVI or MJPEG formats, and there are apps available for it on iPhone and iPad.

TOESV16	16-channel NVR, No Hard Drive, 4 hard Drive Bays for 8TB Max	1012.50
TOSWD5003ABYX	500GB HDD for ESV series ONLY	157.50
TOSWD1003FBYX	1TB HDD for ESV series ONLY	196.88
TOSWD2003FYYS	2TB HDD for ESV series ONLY	337.50



TOESV16 Hard Drive Note:

This recorder is only available without hard drives installed. Simply order the recorder and up to 4 hard drives that do not exceed a total of 8TB. These are removable hard drives, so installation is fast and easy.



Surveillix EHV Series

Surveillix ESV Series recorders are IP/analog hybrid, so you get the best of both worlds. They are great for applications with existing analog system that want to add more cameras. Simply connect the existing cameras to the new recorder and add your new IP cameras. Surveillix ESV recorders come in 2U rack mount chassis. Call for other hard drive sizes.



TOSEHV4-120-500	4 Analog Channel/4 IP Channel DVR, 120FPS @ CIF, 500GB Hard Drive	511.50
TOSEHV4-120-1T	4 Analog Channel/4 IP Channel DVR, 120FPS @ CIF, 1TB Hard Drive	585.00
TOSEHV4-120-2T	4 Analog Channel/4 IP Channel DVR, 120FPS @ CIF, 2TB Hard Drive	643.50
TOSEHV8-240-1T	8 Analog Channel/4 IP Channel DVR, 240FPS @ CIF, 1TB Hard Drive	933.00
TOSEHV8-240-2T	8 Analog Channel/4 IP Channel DVR, 240FPS @ CIF, 2TB Hard Drive	991.50
TOSEHV16-480-1T	16 Analog Channel/4 IP Channel DVR, 480FPS @ CIF, 1TB Hard Drive	1017.00
TOSEHV16-480-2T	16 Analog Channel/4 IP Channel DVR, 480FPS @ CIF, 2TB Hard Drive	1075.50
TOSEHV16-480-4T	16 Analog Channel/4 IP Channel DVR, 480FPS @ CIF, 4TB Hard Drive	1356.00
TOSEHV16-480D-2	16 Analog Channel/4 IP Channel DVR, 480FPS @ D1, 2TB Hard Drive	1548.00
TOSEHV16-480D-4	16 Analog Channel/4 IP Channel DVR, 480FPS @ D1, 4TB Hard Drive	1828.50

Digital Media Streamer



Russound Digital Media Streamer Front



Russound Digital Media Streamer Back



AM / FM Tuner with RDS



AM / FM Tuner with RDS

Apps for iPhone and iPad

- Provides complete control of the Russound MCA-C3, MCA-C5 and all RNET sources
- Complete support for the DMS 3.1 with metadata and album art
- Only \$9.99 from the iTunes store



An Android App Is Coming Soon!

- Four simultaneous stereo outputs:
 - 3 Ethernet streams
 - Built-in Apple AirPlay™
 - Built-in support for streaming SiriusXM radio
 - Built-in support for Internet Radio (vTuner)
 - UPnP / DLNA support for network audio files
 - Dedicated USB ports for local audio files (FAT16 & FAT32)
 - Built-in AM/FM stereo tuner with RDS feedback
- File format compatibility includes MP3 (CBR, VBR), WAV (8, 16-bit), OGG Vorbis, FLAC (8, 16-bit), AAC and AAC+.
- 1U with rack ears included



Why is Apple AirPlay™ Important?

- Choosing a media streamer is often based on the cloud services that are integrated (ie; Pandora, Rhapsody, etc.)
- With AirPlay, any cloud service that can be sent from an iOS Device to a DMS 3.1 stream over Wi-Fi. If you can play it on an iOS device, you can stream it to your MCA system!
- No configuration necessary, simply choose the stream and it plays
- iTunes (Mac or PC) has AirPlay™ support built in
- Third party applications exist for AirPlay™ on PCs and Android
- All 3 DMS 3.1 digital streamers are AirPlay™ enabled

RSDMS-3.1	3 digital streamers + RDS tuner for the MCA-C5 and MCA C3	1150.00
-----------	---	---------

TS3 Touchscreen

New TS3 Interface!



- Full 3.5" color resistive touchscreen with multi-sound feedback
- Compatible with the MCA-C5 and MCA-C3
- Screens are custom-tailored to sources
- Full RNET support, including the DMS3.1 Media streamer. Displays information such as playlist, channel name, artist name, and song title.
- Installs in a 2-gang trim ring
- Configures in seconds; information is pulled from the controller
- Built-in setup and installation screens for the DMS 3.1 streamer
- Easy firmware updates via USB flash drive port

RSTS3-*	Touchscreen for the MCA-C5 and MCA-C3, White (*-B-Bone, BL-Black, BR-Brown)	584.42
RSDTS1-*	Desktop stand for TS3 (*-W-White, BL-Black)	55.00
RS49-70**	TS3 Keypad color change kit (**-09-White, 10-Bone, 11-Black, 12-Brown, 13-Almond)	7.79

A-BUS A-SZ4 Subzone Module



- A-BUS subzone module for use with the MCA-C5 (4 zones) or MCA-C3 (2 zones)
- 4 addressable A-BUS keypad ports
- 1U x 1/2 rack size (same as D250LS)
- Side by side or single mounting in 1U rack
- Rack mount brackets included

How many times are you designing a system only to find you need 1 or 2 extra zones? Instead of eliminating the zones or purchasing another controller, there is a less expensive solution; A-BUS subzoning. The A-SZ4 brings subzoning to the C-Series of controllers. Simply add a module and wire CAT-5 to an A-BUS keypad. The keypad gives separate on/off/volume, yet plays the same source audio as the primary zone. Responds to All On/Off and Page events as configured for the primary zone.

Add zones to an MCA-C5 or MCA-C3 without purchasing additional controllers

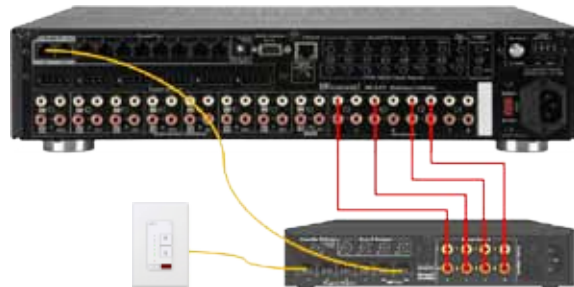

RSA-SZ4	A-BUS subzone module for MCA-C5 (4 zones) & MCA-C3 (2 zones)	299.00
RSA-K4	A-BUS LCD amplified keypad with IR receiver	95.00
RSA-LC3	A-BUS local source input with auto sensing	95.00

MCA-C5 8-Zone Whole House Audio with Tuner

Be certain to add a DMS 3.1 Digital Media Streamer



RSMCA-C5 Front



RSMCA-C5 Back

RSKT2-C5	MCA-C5, (6) white MDK-C6 keypads, remote, (8) 845.1 emitters, rack ears, antennas	2600.00
RSKT2-C5S	MCA-C5, (6) white SLK-1 keypads, remote, (8) 845.1 emitters, rack ears, antennas	2200.00
RSMCA-C5	8-source audio/video input, 8-zone audio/video output with 40W/Ch (zones 1-6, line out 7-8), routed IR, RS-232, paging, rack ears, antennas	1500.00

Features:

- 8 zones: 40W/Ch zones 1-6, zones 7 and 8 Line Out only
- Use 6 MCA-C5 systems for a 48-zone system
- Built-in AM / FM Tuner with RDS information
- 8 audio inputs with digital gain and buffered loop outputs
- Input 8 can be reassigned as an auto-sensing page
- Displays information from RNET / RIO devices on keypads
- Compatible with MDK-C6, SLK-1, TS3, and Russound App
- Preamp or fixed line out for all 8 zones
- Adjustable bass, treble, balance and loudness
- Built-in IR learner and library IR codes
- Routed IR for source control
- Software is a free download
- Programming and updates via USB port or Ethernet
- Source Linking ensures selected zones always play the same source
- Zone Linking locks multiple zones together for all functionality
- Source Mapping allows sources to only be available in selected zones
- Built-in IR learner and library IR codes
- Programmable IR macro capability
- Built-in clock, sleep timer, and alarm clock functions
- TS3 touchscreens can be powered directly from the MCA-C5
- Serial and Ethernet ports for control and updates and RIO connectivity
- Rack-mount hardware is included, 2-unit high
- Compatible with HAI OmniPro II

Double Warranty with Russound Speakers! See p.127



Keypads and Accessories for the MCA-C3 and MCA-C5

RSMDC-C6	2-gang keypad for use with the MCA-C5 and MCA-C3. White.	199.00
RS1550-534***	MDK-C5 Keypad Color Change Kits (***) 430-White, 447- Light Almond, 409-Bone, 393-Black, 416-Brown)	6.00
RSSLK-1	Single keypad for use with the MCA-C5 and MCA-C3. White	155.00
RS1550-534***	MDK-C6 Keypad Color Change Kits (***) 492-White, 485- Light Almond, 461-Bone, 454-Black, 478-Brown, 485-Almond)	15.00
RSDTS2.*	Desktop stand for the MDK-C6 keypad (W-White, B-Black)	55.00

Volume Indicator:

Shows volume level, or if Mute function is activated

Home Button:

Returns view to the home screen

Menu Button:

List of options, such as sources, favorites, or functions

Power Button:

Control individual zone power as well as all on/off

Zone Favorites:

Save and recall zone settings including source and volume



RSMDC-C6

IR Receiver:

Receives remote control signals for system and source equipment from Russound and third party remote controls. IR Talk-back LED lights to confirm when a signal is received

Status Box:

Shows system and zone status messages, such as shared sources, Party Mode, Party Master, or Do Not Disturb

Simple Navigation:

Navigate up and down through menus, or press (slow) or press and hold (fast) to move up and down through menu lists



RSSLK-1



C-Series Controller on HAI 5.7e

MCA-C3 6-Zone Whole House Audio with Tuner

Be certain to add a DMS 3.1 Digital Media Streamer



RSMCA-C3 Front



RSMCA-C3 Back

RSKT2-C3	MCA-C3, (6) white MDK-C6 keypads, remote, (6) 845.1 emitters, rack ears, antenna	1899.00
RSKT2-C3S	MCA-C3, (6) white SLK-1 keypads, remote, (6) 845.1 emitters, rack ears, antenna	1650.00
RSMCA-C3	6-source audio/video input, 6-zone audio/video output with 20W/Ch, routed IR, RS-232, paging, power management, rack ears	1250.00

Features:

- 6 zones: 20W/Ch
- Use 6 MCA-C3 systems for a 36-zone system
- Compatible with MDK-C6, SLK-1, TS3, and Russound App
- Built-in AM / FM tuner with RDS information
- 6 audio inputs (including the built-in tuner)
- Input 6 can be reassigned as a page
- Displays information from RNET / RIO devices on keypads
- Adjustable bass, treble, balance and loudness
- Built-in IR learner and library IR codes
- Routed IR for source control
- Rack-mount hardware is included, 2-unit high
- Programming via front USB port or Ethernet. Software is a free download.
- Source Linking ensures selected zones always play the same source
- Zone Linking locks multiple zones together for all functionality
- Source Mapping allows sources to only be available in selected zones
- Programmable IR macro capability
- Built-in clock, sleep timer, and alarm clock functions
- Serial and Ethernet ports for control and updates and RIO connectivity
- Compatible with HAI OmniPro II

Double Warranty with Russound Speakers! See p.127



Bluetooth C-Series RNET Source Kit



Russound Bluetooth Source

- The BTC-1 termination box installs by the C-Series Controller
- The BTC-1X remote transceiver installs in a central location for optimal coverage (15m range)
- Run a CAT-5 from the termination box to the remote transceiver



RSBSK1	RNET Enabled 2 piece Bluetooth interface for C-Series systems	129.00
--------	---	--------

Looking to integrate the latest streaming service? If you can hear it on a device with *Bluetooth*, you can play it through your Russound system with the RSBSK1 *Bluetooth* Source Kit

- Adds *Bluetooth* audio streaming to C-Series controllers
- Enjoy digital audio from a personal music player, smart-phone or computer through a C-Series multiroom system
- Termination box powers transceiver over CAT-5
- Can be configured as a Priority Local Source for a particular zone

RNET Enabled iPod™ Docks



Russound iBridge Dock

- Integrate an iPod up to 300' over Cat 5e
 - Full RNET integration
 - Choose Artist, Album, Song or Playlist from MDK-C6, TS3 and "My Russound" App
 - Full metadata on MDK-C6, TS3 and "My Russound" app
- Supports revision 3.0 and higher iPods



RSBGK1	iBridge Dock Kit: iPod™ Dock, A/V Decoder, power supplies	339.00
--------	---	--------

ST1 RNET Tuner

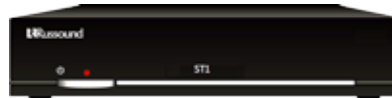

Russound RDS Tuner

- Single AM/FM tuner with RDS
- 6 Banks with 6 Presets each
- Built-in power supply
- Use with C-Series controllers
- Great solution for multiple tuners
- 1U x 1/2 rack size (same as D250LS)
- Side by side or single mounting in 1U rack
- Antennas & rack mount brackets included

RSST1	RNET Enabled Tuner with RDS Support. Compatible with C-Series controllers	210.00
-------	---	--------

Component Video Switching



VM1-8UC2 Rear View

- Component Video Switching for MCA-C5, MCA-C3, or CAA
- Fully RNET compliant, either plug-and-play or use the free video matrix software for configuration
- Fully-integrated active baluns provide up to 1080p component video over 300' of standard Cat 5e wire
- Optional up-conversion from composite or S-video for support of cameras and other legacy devices
- 2U rack mount ears included

RSVM1-4	Component Video Matrix Switcher: 4-source/4-zone, includes power supply and receivers	1095.00
RSVM1-4UC	Component Video Matrix Switcher: 4-source/4-zone, up-conversion on 2 sources, includes power supply and receivers	1395.00
RSVM1-8	Component Video Matrix Switcher: 8-source/8-zone, includes power supply and receivers	1695.00
RSVM1-8UC	Component Video Matrix Switcher: 8-source/8-zone, up-conversion on 2 sources, includes power supply and receivers	1995.00
RSVM1-8UC2	Component Video Matrix Switcher: 8-source/8-zone, up-conversion on 4 sources, includes power supply and receivers	2295.00



VM-1 Video Matrix Software (Free)

RNET Serial Connection Sharing

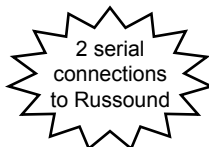

If 2 serial connections are needed for a Russound system then the second port can be obtained from a Russound ST2 or Avocation Systems SR-2. If more than 2 ports are needed, then multiple SR-2's can be stacked to achieve additional serial ports.

AVOSR-2	Serial Adapter for connecting 2 controllers to Russound RNET systems	75.00
X781ERGPS	12VDC Power Supply	9.97

Add Component Video Switching for the MCA-C5, MCA-C3 or CAA with the VM-1

RNET Enabled Controller Accessories

RSSRC-C5	Universal/Learning Remote for use with MDK-C5 and MDK-C6 Keypads	39.00
RSSRC2	Universal/Learning Remote for use with Russound's multiroom systems	39.00
RSSA-ZX3	Keypad Zone Splitter with power supply	49.00
RS2500-521065	Advanced Programming cable for KP4, KP6, KPL, ISK1, ISK2, ISK3, ISH1	16.36

CAA66 Multi-Source / Multi-Zone Audio System

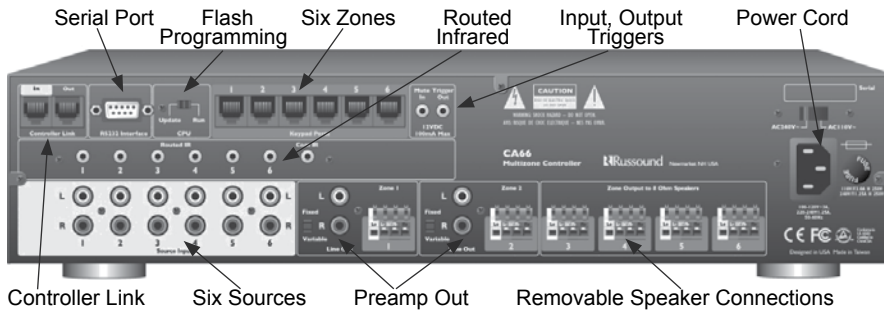

Features:

- All of the CAS44 features
- 6 audio inputs
- 6 zones with 40W per zone
- Serial port
- IR library and learning IR
- Routed IR source selection
- 12VDC mute input, trigger output
- Preamp or fixed output zones (1/2)
- Link 6 CAA66s for a 6x36 system
- Compatible with HAI OmniPro II

Double Warranty with Russound Speakers! See p.127



RSCAA66	6-source input, 6-zone output with 40W per zone, serial port, routed IR, mute in, trigger output, fixed or variable preamp outputs for zones 1 and 2, controller link, punchdown tool	799.00
RSCAA66L-W	CAA66, (6) white KPL keypads, remote, (6) 845.1 IR emitters, rack ears	1299.00
RSCAA66K-W	CAA66, (6) white KP6 keypads, remote, (6) 845.1 IR emitters, rack ears	1049.00
RSSRC1	Remote for use with RSCAA66	29.00



RSKP6

CAA66 Keypads

RSKPL-W	Single-gang keypad for CAS44 and CAA66 controllers	155.00
RSKP6-W	Single-gang 6-source keypad for CAA66 controllers	79.00
RSKPSC-W	Source control keypad for CAA66 controllers, works with KP6 and KPL	39.00

White and Almond included



RSKPL RSKPSC

CAA66 Keypad Color Change Kits

RSKPL6-*	Color change kit for RSCAA66L and RSCAS44L (Quantity 6 inserts)	18.00
RSKP66-*	Color change kit for RSCAA66K (Quantity 6 inserts)	18.00
RSKPSC6-*	Color change kit for RSKPSC (Quantity 6 inserts)	18.00

(*W-White, A-Almond, B-Bone, BL-Black, BR-Brown)

CAS44 Multi-Source / Multi-Zone Audio Systems

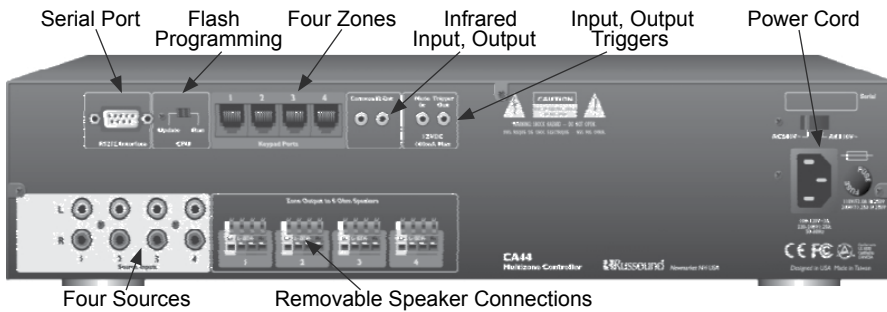

Features:

- 4 audio inputs
- 4 zones with 40W per zone
- Serial port
- 12VDC mute input, trigger output
- Flexible keypad options
- Removable speaker connections
- All zones off command
- Bass, treble, and loudness control
- Link 2 CAS44s for a 4x8 system
- Compatible with HAI OmniPro II

Double Warranty with Russound Speakers! See p.127



RSCAS44	4-source input, 4-zone output, 40W per zone, serial port, common IR, trigger out, mute in, punchdown tool	499.00
RSCAS44L-W	CAS44, (4) white KPL keypads, remote, (2) 1584.1 IR emitters, rack ears	999.00
RSCAS44K-W	CAS44, (4) white KP4 keypads, remote, (4) 845.1 IR emitters, rack ears	749.00
RSCAS-RC	Remote for use with RSCAS44	39.00

CAS44 Keypads

RSKPL-W	Single-gang keypad for CAS44 and CAA66 controllers	155.00
RSKP4-W	Single-gang 4-source keypad for CAS44 controllers	69.00

White and Almond included

CAS44 Keypad Color Change Kits

RSKPL6-*	Color change kit for RSCAA66L and RSCAS44L (Quantity 6 inserts)	18.00
RSKP46-*	Color change kit for RSCAS44K (Quantity 6 inserts)	18.00

(*W-White, A-Almond, B-Bone, BL-Black, BR-Brown)



RSKP4 RSCASRC

CA-4 Multi-Source / Multi-Zone Audio System (non-A-BUS)



RSCA4-KP



RSCA4

Features:

- 4 audio inputs
- 4 zones with 30W per zone
- Use 2 systems for an 8-zone system
- Party mode on command
- Command for All Zones Off
- Source grouping
- Bass, treble, loudness control
- Serial port
- 12VDC mute input, trigger output
- Keypad/speaker connection plate
- Compatible with HAI OmniPro II one-way communication

Double Warranty with Russound Speakers! See p.127



RSCA4-KT1	CA4 controller, (4) CA4-KP keypads, remote, (4) 845.1 emitters, rack ears	581.82
RSCA-4	4-source input, 4-zone output with 30 watts per zone, RS-232 (1-Way HAI communication), routed IR, rack ears	414.55
RSCA4-WP	Single-gang in-wall connection plate for the CA4 system. 4 RJ-45 inputs, 4 RJ-45 outputs, and 4 pair of speakers	36.36
RSCA4-KP	Single-gang keypad for the CA4	61.30
RS1200-53-10**	CA-KP color change kit (**-57-White, 64-Almond, 95-Bone, 71-Black, 95-Brown), includes kits for 4 keypads and 1 wall port	18.70
RSCA4-RC	Learning IR remote for use with the CA4 system, controls 4 devices	41.56

ComPoint Intercom

ComPoint™

The Music Lover's Intercom Solution



RSISK2 Advanced Keypad:

- LCD with assignable descriptions
- Volume Control and Do Not Disturb
- Integrated 50 WPCH relay allows sharing speakers with whole house audio
- Integrated paging amplifier and microphone
- Selectable amber or green backlighting



RSISK3 Outdoor Intercom Station

RSISH1	System hub, (6) intercom zones, (2) door stations, (7) chimes, link 6 hubs for 36 stations, requires RSISPS	199.00
RSISPS	ComPoint power supply	35.00
RSISK2-*	Advanced LCD ComPoint keypad, assignable zone names	160.00
RS49-7039*	ISK2 color change kits: (*-A-White, B-Almond, C-Bone, D-Brown, E-Black)	2.06
RSISK3-AB	Weatherproof door station, plated die-cast zinc. Antique Brass finish.	119.00
RSISK4	Weatherproof door station with integrated black and white camera. Antique Brass finish.	265.00

*-W-White and Almond, B-Bone, BL-Black, BR-Brown



RSISSP Single Gang Speaker

ComPoint Intercom Packages

RSISA4	4-zone advanced package with door station: (4) ISK2, (1) ISH1, (1) ISPS, (1) ISK3AB	999.00
RSISA6	6-zone advanced package with door station: (6) ISK2, (1) ISH1, (1) ISPS, (1) ISK3AB	1313.00
RSISA62	6-zone advanced package with 2 door stations: (6) ISK2, (1) ISH1, (1) ISPS, (2) ISK3AB	1432.00
RSISA60	6-zone advanced package: (6) ISK2, (1) ISH1, (1) ISPS	1194.00

Note: White and Almond included. ComPoint kits do not include wallplates. See page 31 for Leviton wallplates.



RSISDH1 System Hub

ComPoint Accessories

RSISSP	Single-gang speaker for ComPoint, White and Almond included (B-Bone, BL-Black, BR-Brown)	20.00
RSISSP-4-*	ISSP color change kit 4-pack (*-W-White, A-Almond, B-Bone, blank-Brown, BL-Black)	10.00
RS2500-521065	Advanced programming cable for KP4, KP6, KPL, ISK1, ISK2, ISK3, ISH1, MDK-C5 and BGK1	16.36
RSISDR1	Door Strike Release Module, NO and NC contacts, relay rated for 1A @ 12VDC	45.00



RSISDR1

A-BUS Controller - 6-Source, 8-Zone

RSA-C560	A-BUS Controller kit: AC-68 controller, (6) white A-K6L keypads, A-SRC1 remote, rack ears, (6) 845.1 IR emitters	1399.00
RSA-C68	6-source, 8-zone A-BUS controller, 1U, rack-mountable chassis, internal power supply, on-board IR code library and IR learning, independent source gain control, sleep timer, page input, source power management, party mode	799.00
RSA-SRC1	A-BUS IR remote for the A-C68, features source selection and control for 6 sources and a local source	39.00
RSA-LRC2	Learning / Pre programmed IR remote, features source selection and control for up to six system sources and one local source. Includes programmed codes for most major brands of A/V equipment.	40.00



RSA-C68



RSA-SRC1



RSA-LRC2

A-BUS Amplified Volume Control Keypads and Accessories



RSA-K4

RSA-K6L

RSA-K6L	A-BUS digitally amplified volume control, LCD panel with assignable source labels, IR receiver, tone control, pre-amp output, source selection, RJ-45 connector to controller, use with A-C68, A-H484 and A-SZ4 A-BUS subzone modules, white	189.00
RSA-KSC2	A-BUS Source Control Keypad, 11 transport and numeric keys, attaches to the RSA-K6L, white	49.00
RSA-K4	A-BUS amplified keypad with IR receiver, pre-amp output, system status, 1 - 4 - and 6-source selection, white	95.00

A-BUS System Kits

RSA-M440	4-zone kit: (4) amplified A-K4 keypads, A-H484 surface-mount hub, A-PS power supply, A-LRC2 learning remote, (4) 845.1 dual emitters, white	750.00
RSA-D440	4-zone kit: (4) amplified A-K4 keypads, A-H4D surface-mount hub, A-PS power supply, A-LRC2 learning remote, 1584.1 dual emitter, punchdown tool, white	495.00
RSA-S440	4-zone kit: (4) amplified A-K4 keypads, A-H4 surface-mount hub, A-PS power supply, A-LRC2 learning remote, 1584.1 dual emitter, white	505.00

A-BUS Local Source Modules



4-Conductor Speaker Wire

- A huge benefit of A-BUS is the Local Source feature
- Local Source allows a customer access to 'whole house' sources connected at the hub as well as audio sources in the room
- Local source is great for portable media (iPhone, iPod, iPad, Android) as well as media in the room such as televisions and media streamers



A-BUS Hub

RSA-LC3

RSBTA-1

- Wire in between the A-BUS hub and the volume control
- When audio is sensed on the front RCA jacks, the module will automatically switch from the main source to the local source. When audio is removed, the module will return to the audio provided by the hub.
- Adjustments for switching sensitivity and delay
- Infrared emitter port allows control of the local source via infrared repeating

RSA-LC3	A-BUS local source input with IR emitter output, auto sensing to override audio, white	65.00
---------	--	-------

BTA-1 A-BUS - Bluetooth Local Source Module

- *Bluetooth* local source module for A-BUS systems and subzones
- Acts like an A-LC3 but uses *Bluetooth* instead of analog RCA inputs to receive audio from a personal music player, smart-phone, tablet or PC
- Stream *Bluetooth* audio from up to 15 meters away
- Custom naming for easy identification
- *Bluetooth* 2.1 and EDR/Class 1 with A2DP Profile

RSBTA-1	<i>Bluetooth</i> enabled local source module for A-BUS systems	79.00
---------	--	-------

A-BUS Hubs / Source

RSA-H4D-*	In-wall single-source 4-zone hub, double-gang work box, (4) IR emitter jacks, requires A-PS	99.00
RSA-H4DX-*	In-wall single-source 4-zone expansion hub, 3-gang work box, for use with A-H4D and A-PS	70.00
RSA-H484	Surface-mount 4-source, 4-zone hub, (4) routed IR emitter jacks, (1) common IR jack, 12V trigger	299.00
RSA-H4	Surface-mount single-source, 4-zone hub, (4) IR emitter jacks, IR link input/output, confirmation LED	109.00
RSA-H2	Surface-mount single-source, 2-zone hub, (4) IR emitter jacks, IR confirmation LED	79.00
RSA-H1	Surface-mount single-source input for use with A-BUS hubs, (4) IR emitter jacks	64.00
RSA-H4P	Structured wiring mount single-source, 4-zone distribution hub, requires A-PS and A-BUS source	109.00
RSA-PS	A-BUS power supply, 24VDC, detachable power cord, provides clean and regulated power	85.00

(*W-White and Almond, B-Bone, BL-Black, BR-Brown)



RSA-H4D



RSA-H4

A-BUS Color Conversion Kits

RSA-H4DCONV-*	Color conversion for A-H4Dx kit: Decora audio plate, Decora IR plate, A-H4Dx plate (*W-White, A-Almond, B-Bone, BL-Black, BR-Brown)	10.00
RS2000-534***	A-K6L color conversion 4 pack (***-676-White, 683- Almond, 690-Bone, 713-Brown, 706-Black, 720- Light Almond)	TBD
RS2000-534***	A-KSC2 color conversion 4 pack (***-744-White, 751-Almond, 768-Bone, 782-Brown, 775-Black, 799- Light Almond)	10.00
RS2000-534***	A-K4 color conversion 4 pack (***-607-White, 614- Almond, 621-Bone, 645-Brown, 638-Black, 652- Light Almond)	TBD
RS2000-***	A-LC3 color conversion 4 pack (***-528736-White, 528743-Almond, 528750-Bone, 528767-Brown, 534774-Black, - Light Almond)	10.00

ALTx Series 1x, 2x, 4x, 8x Autoformer Impedance Matching Volume Controls - 126W

RSALTX-2*	Standard plate and knob, 126W stereo impedance matching volume control, detachable 12-gauge connector, White and Light Almond included, (*BL-Black, BR-Brown)	30.55
RSALTX-MP-2*	Master Pack: 30 ALTx-2 controls, White and Light Almond included, (*BL-Black, BR-Brown)	799.00
RSWALTX-2	Weatherproof standard plate and knob, 126W stereo impedance matching volume control, fits a standard 3/4" PVC outdoor conduit, Gray only	67.81
RSALTX-WIRI2D-*	Decora plate and knob with IR receiver, 126W stereo 1x, 2x, 4x, 8x selectable impedance matching volume control, 14-gauge QCT connector, wallplate included. *W-White and Light Almond, BL-Black, BR-Brown	79.00
RSALTX-2D*	Decora plate and knob, 126W stereo impedance matching volume control, detachable 12-gauge connector, wallplate included, White and Light Almond included, (*BL-Black, BR-Brown)	30.55
RSALTX-MP-1*	Master Pack: 30 ALTx-2D controls, White and Light Almond included, (*BL-Black, BR-Brown)	799.00
RSTBL-75	Tabletop, 126W stereo 1x, 2x, 4x, 8x selectable impedance matching volume control w/ headphone jack speaker override	75.60

Impedance Matching Volume Controls: A Great Value

In today's high tech digital world, sometimes it is the simple solution that is overlooked. What can be simpler to offer, specify, or install than impedance matching volume controls?

Turn it on, off, up or down. Russound volume controls allow customers to enjoy the music anywhere in their home. Russound is known for their autoformer impedance matching technology, long term reliability, and lifetime warranty.

Start with an amplifier (next page). For background audio throughout the home budget 20 watts per channel (8Ωs) per room. Choose if you want to use a speaker switcher (next page) and the appropriate volume controls. If a speaker switcher is not being used consider using the EZB-1SC distribution block (below) for a clean installation.

RSALTX-WIRI2D

RSALTX-2
Russound Wallplate Solutions

RSHTP-1	Home Theater 2-gang plate, binding posts front left and right, center, sub (speaker & RCA), rear left and right	28.00
RSHTP-2	Home Theater 2-gang plate, binding posts for 5.1, 6.1 and 7.1, 2 "F" connectors, 2 RCAs for sub woofers	32.00

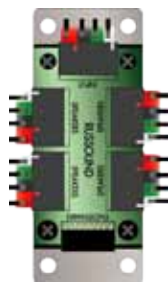
RSHTP-1
Volume Control Accessories

RSEZB-1SC

RSEZB-1SC	4-volume Control Connecting Block, 1 amplifier input, 4 speaker outputs, 14-gauge snap connector	32.00
RSEZB-2SC	4-volume Control Expansion Block, 4 speaker outputs, 14-gauge snap connector, plugs into EZB-1SC	29.00
RS1201A	1 Amp 12VDC PS for Smart Select Volume Controls	13.30
RSSP-6-*	Single-gang plastic plate for ALTx, LPTx and A70-1M models (6-pack)	10.00
RSDP-6-*	Decora inserts, fits ALTx, LPTx and A70-1M models (6-pack)	10.00
RSVCK-6-*	Plastic volume control knobs, fits ALTx, LPTx and A70-1M models (6-pack)	10.00

(*W-White, LA--Light Almond, A-Almond, B-Bone, BL-Black, BR-Brown)

Waterproof Covers

RSWPB37-23	Vertical self-closing cover with 3/8" gasket and 2 mounting screws	10.67
RSWPB37-23FS	Same as above, mounts to flat surface w/ 4 screws	12.05
CARE9U2CRN2	Double gang, surface mount clear outdoor cover	31.03

RSWPB 37-23

CARE9U2CRN2

Single Source Resistor-Based Speaker Selectors



SS-6.2

RSSS-4.2	4-pair speaker selector, 100w/Ch RMS, for use with 4Ω stable amplifiers	64.45
RSSS-6.2	6-pair speaker selector, 70w/Ch RMS, for use with 4Ω stable amplifiers	86.70

A/B Speaker Selectors



AB-3.2

RSAB-1.2*	Decorator style in-wall A/B speaker/amplifier selector (*W-White, LA-Light Almond, A-Almond, B-Bone, BL-Black, BR-Brown)	23.65
RSAB-2.2	Freestanding manual A/B speaker/amplifier selector	45.60
RSAB-3.2	Auto A/B speaker level switching, selectable delay and sensitivity, 110VAC	75.00

Autoformer-Based Speaker Selectors with UltraMatch™ Volume Controls



RSSDB-4.1

RSSDB-4.1	4-pair speaker selector with UltraMatch™ Volume Controls, 2x, 4x, 8x impedance settings, 200w/Ch RMS, detachable 14-gauge color-coded snap connectors, zone identifying labels	238.90
-----------	--	--------

Autoformer-Based Speaker Selectors



RSPRO-6HP

RSPRO-6HP	6-pair speaker selector with adjustable impedance matching, 100w/Ch RMS w/ subsonic filter built in, detachable 14-gauge color-coded snap connectors, zone identifying labels	205.60
-----------	---	--------



RSPRO-12HP

RSPRO-8HP	8-pair speaker selector with adjustable impedance matching, 200w/Ch RMS w/ subsonic filter built in, detachable 14-gauge color-coded snap connectors, zone identifying labels	233.40
-----------	---	--------

RSPRO-12HP	12-pair speaker selector with adjustable impedance matching, 200w/Ch RMS w/ subsonic filter built in, detachable 14-gauge color-coded snap connectors, zone identifying labels	277.80
------------	--	--------

R-Series Amplifiers

RSD250-LS	1-zone/2-channel amplifier, auto A/B amplified switching capabilities, 12VDC in/out, video sensing, line-level or speaker-level switching, 50W/Ch @ 8Ω (75W/CH @ 4Ω), bridgeable to 140W @ 8Ω, gain control. Includes surface/rack mounting hardware.	199.00
RSR290DS	2-channel amplifier: 90w@8Ω, 110w@4Ω, bridged mono 250w@8Ω, 12VDC input and output trigger, auto signal-sensing, separate gain controls, local source switching, thermal and short protection, rack ears	275.00
RSR850MC	8-channel amplifier: 35w@8Ω, 50w@4Ω, bridgeable to 100w, 12VDC input and output trigger, auto signal-sensing, separate gain controls, thermal and short protection, rack ears, bus input-output	665.00
RSR1250MC	12-channel amplifier: 35w@8Ω, 50w@4Ω, bridgeable to 100w, 12VDC input and output trigger, auto signal-sensing, separate gain controls, thermal and short protection, rack ears, bus input-output	865.00



RSD250-LS



RSR290DS



RSR1250MC

Amplifier Features	RSX75	RSX125	D250LS	R290DS	R850MC	R1250MC
Total channels	2	2	2	2	8	12
Auto signal sensing inputs	Y	Y	Y	Y	Y	Y
Separate channel gain controls	N	Y	Y	Y	Y	Y
Short-circuit protection	Y	Y	Y	Y	Y	Y
Rack mount ears included	N	N	Y	Y	Y	Y
12-volt trigger input and output	N	Y	Y	Y	Y	Y
Bus input and output	N	N	-	-	Y	Y
Source loop outputs	Y	Y	-	Y	-	-
Automatic local source switching	N	Y	Y	Y	-	-
Front panel controls	Y	Y	N	N	N	N

X-Series Amplifiers

RSX75	2-channel amplifier, 60w@8Ω, 75w@4Ω, bridged mono 160w@8Ω, auto signal-sensing source selection, thermal and short protection, local source switching, front panel controls	125.00
RSX125	2-channel amplifier, 80w@8Ω, 125w@4Ω, bridged mono 250w@8Ω, 12VDC input and output trigger, auto signal-sensing source selection, separate gain controls, thermal and short protection, local source switching, front panel controls	300.00



RSX75



RSX125

RSIRJ-1 Kit

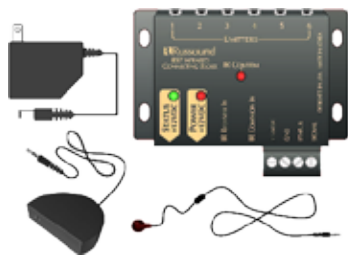

- Many custom audio-video systems use infrared commands to operate source equipment
- Infrared commands cannot pass through walls or cabinet doors
- Russound's SaphIR® infrared repeating products allow installers to place audio/video products in locations that are aesthetically pleasing or more convenient
- Use an infrared receiver to capture a command, a distribution block to inject power and an emitter to issue the command to the audio/video component
- For shorter distances, use the supplied cables; for longer distances, Category 5 cable works great
- Infrared receivers are available in standard CFL-friendly and plasma versions. Plasma versions are less susceptible to infrared interference generated by many different sources including plasma television screens
- Blue signal confirmation LED allows customers to visually confirm that an infrared command has been received
- Russound receivers are available in several different styles to blend into any decor

Russound SaphIR Receivers and Keypads

RS858-*	CFL-friendly decora in-wall receiver, status (Red) and talkback (Blue) confirmation LEDs	39.00
RS858P-*	Plasma-friendly decora in-wall receiver, status (Red) and talkback (Blue) confirmation LEDs	150.00
RS860-*	CFL-friendly Phantom receiver, mini surface-mount (*W-White, BL-Black)	51.00
RS860P*	Plasma-friendly Phantom receiver, mini surface-mount (*S-Silver, BL-Black)	51.00
RS862	CFL-friendly Eye receiver, ½" flush-mount barrel (White, Black, and Brass bezels included)	55.00
RS862P	Plasma-friendly Eye receiver, ½" flush-mount barrel (White, Black, and Brass bezels included)	150.00
RS854	CFL-friendly Mini Tabletop receiver with Blue IR confirmation LED, Black	38.00
RS854P	Plasma-friendly Mini Tabletop receiver with Blue IR confirmation LED, Black	149.51

(*W-White, A-Almond, B-Bone, BL-Black, BR-Brown) - wallplate not included

SaphIR Phantom

854 Mini Receiver

Russound SaphIR Infrared Kits

RSIRJ-1	Tabletop Kit: (1) 854 tabletop receiver, (1) 857 connecting block, (1) 846C power supply, (4) 845.1 emitters	69.00
RSIRJ-1P	Plasma Tabletop Kit: (1) 854P tabletop receiver, (1) 857 connecting block, (1) 846C power supply, (4) emitters	180.00
RSIRJ-2	Flush Kit: (1) 862 eye flush receiver, (1) 857 connecting block, (1) 846C power supply, (4) 845.1 emitters	105.00
RSIRJ-2P	Plasma Flush Kit: (1) 862P eye flush receiver, (1) 857 connecting block, (1) 846C power supply, (4) emitters	190.00
RSIRJ-3	Connecting Block Kit: (1) 857 connecting block, (1) 846C power supply	29.00
RSIRJ-4	Phantom Kit: (1) 860 Phantom mini receiver, (1) 857 connecting block, (1) 846C power supply, (4) emitters	99.00
RSIRJ-4P	Plasma Phantom Kit: (1) 860P Phantom receiver, (1) 857 connecting block, (1) 846C power supply, (4) emitters	190.00
RSIRK-1-*	Single Room Repeating Kit: (1) 858 decora IR in-wall receiver, (2) 1584.1 dual micro IR emitters, (1) 857 surface-mount IR connecting block, (1) 846C power supply, wallplate not included (*W-White, A-Almond)	80.00
RSIRK-1P-*	Single Room Plasma Kit: (1) 858P Plasma-friendly decora IR in-wall receiver, (2) 1584.1 dual micro IR emitters, (1) 857 surface-mount IR connecting block, (1) 846C power supply, wallplate not included (*W-White, A-Almond)	180.00

SaphIR Eye

858 Receiver

Russound SaphIR Distribution Blocks and Accessories

RS857	Surface mount connecting block, (1) receiver input, (6) emitter outputs, 12VDC, status and talkback LED	26.70
RSIRB-6	In-wall SaphIR decora connecting block, supports up to 4 emitters and 12 receivers, 12VDC input, IR confirmation, requires 846C power supply-White only	32.20
RSIRB-1	In-wall connecting block, decora, for use with 854 mini tabletop receiver-White only	17.80
RS846C	Power Supply, 110VAC input, 12VDC 200mA output	7.35
RS1201A	Power Supply, 110VAC input, 12VDC 1000mA output	13.30
RS900	50' extension cable for use with SaphIR targets, 3.5 mm stereo male / female	4.70

857 Connecting Block

Russound IR Emitters

RS845.1	Micro IR emitter, 6' cable	7.00
RS845.2	Micro IR low-output emitter, 6' cable	7.00
RS1584.1	Dual Micro IR emitter, 10' cable	10.55
RS1584.2	Dual Micro IR low-output emitter, 10' cable	11.00

RS845.1

- The 1/8" mini plug is plugged into a connecting block
- The emitter side is placed over top of an A/V components' IR receiver window
- Russound emitters are compatible with most IR repeating systems
- Miniature head unobtrusively attaches to your equipment
- Plug-in design installs quickly
- 10' (3 m) cable accommodates most installation scenarios



Change from a ceiling speaker to a wall speaker by changing the grill



Say goodbye to crooked in-wall installations, simply rotate the grill until it is level!

Acclaim Thin Bezel Speakers

RSRSF-61	2-way speaker: 6.5" Polypropylene woofer, ¾" pivoting PEI tweeter, 5 - 80 watts, pair	50.00
RSRSF-61T	Single point stereo: 6.5" IMPP Ribbed woofer, two ¾" pivoting PEI tweeters, 5 - 120 watts, each	50.00
RSRSF-62	2-way speaker: 6.5" Polypropylene woofer, 1" pivoting Silk tweeter, 5 - 90 watts, pair	100.00
RSRSF-63	2-way speaker: 6.5" IMPP Ribbed woofer, 1" pivoting Silk tweeter, 5 - 100 watts, pair	150.00
RSRSF-64	2-way speaker: 6.5" Kevlar woofer, 1" pivoting Teteron tweeter, 5 - 120 watts, pair	200.00

Acclaim Angled Thin Bezel Speakers

RSRSA-61	2-way 15° angled speaker: 6.5" Polypropylene woofer, 1" pivoting PEI tweeter, 5- 80 watts, each	75.00
RSRSA-62	2-way 15° angled speaker: 6.5" IMPP Ribbed woofer, 1" pivoting Silk tweeter, 5- 100 watts, each	100.00
RSRSA-63	2-way 15° angled speaker: 6.5" Kevlar woofer, 1" pivoting Teteron tweeter, 5- 120 watts, each	150.00

Acclaim Angled Thin Bezel Speaker Grilles

RSRSG-R	Replacement Round Speaker Grilles for Russound RSA- and RSF-model speakers - white	12.51
RSRSG-S	Square Speaker Grilles for in-wall Russound RSA and RSF speaker installations	12.51

Acclaim Thin Bezel Speaker Rough-In Brackets

RSSB-C67	Rough-in bracket for Acclaim 6½" Thin Bezel Speakers, Pair (add -6P for 6 pack pricing)	Pair 15.00	6-Pack (-6P) 75.00
----------	---	-------------------	---------------------------

Acclaim 5 OutBack™ Outdoor Speakers (Weather Resistant)



Outback Bracket



Outback Stand



Outback Bookshelf

The Acclaim 5 Outback speakers provide a unique mounting system. Each speaker includes a foot for bookshelf applications and a tapered bracket that allows wall, corner, or pole mounting.

RS5B45*	Indoor/outdoor: 4" polypropylene cone, 1" Teteron™ tweeter, power handling from 10 - 100 watts, 8Ω, Pair	99.00
RS5B55*	Indoor/outdoor: 5.25" polypropylene cone, 1" Teteron™ tweeter, power handling from 10 - 125 watts, 8Ω, Pair	130.00
RS5B65*	Indoor/outdoor: 6.5" polypropylene cone, 1" Teteron™ tweeter, power handling from 10 - 150 watts, 8Ω, Pair	175.00
RS5B65S*	Single-point stereo indoor/outdoor: 6.5" injection-molded polypropylene cone, (2) 1" Teteron™ tweeters, multiple mounting options, power handling from 10 - 150 watts, 8Ω, Pair	125.00

(*W-White, BL-Black)

OutBack™ Rock Speakers

RS5R82-G	8" 2-way Outdoor Rock Speaker: Gray Granite - each	155.00
RS5R82-S	8" 2-way Outdoor Rock Speaker: Sandstone - each	155.00
RS5R82-W	8" 2-way Outdoor Rock Speaker: Weathered Granite - each	155.00
RS5R82S-G	8" Single Point Stereo Outdoor Rock Speaker: Gray Granite - each	170.00
RS5R82S-S	8" Single Point Stereo Outdoor Rock Speaker: Sandstone - each	170.00
RS5R82S-W	8" Single Point Stereo Outdoor Rock Speaker: Weathered Granite - each	170.00



RS5R82 Rock Speaker

AirGo Outdoor

RSAGO-1	Outdoor Sound System. A portable amplifier speaker dock for an Apple® AirPort Express®	279.99
---------	--	--------

High-Performance Fire-Rated Flexbox Speaker Back Boxes

RSFBC1-FR	In-ceiling, high-performance, fire-rated, speaker back box: 14"W x 6"D x 17.5"H. Recommended for retrofit applications.	99.00
RSFBW1-FR	In-wall, high-performance, fire-rated, speaker back box: 14"W x 3.65"D x 16.5"H	99.00



Flexbox speaker back boxes reduce background noise, provide a moisture barrier, diffuse distortion, and improve sound quality. The flexible construction allows for easy installation in retrofit or new construction settings. Both models are flame retardant and meet ASTM E119 and UL 263/ NFPA 251 (1-hour) and ASTM E84/ NFPA 70 standards. Sound Transmission Class (STC) is 32 dB.

In-Ceiling Retrofit Installation

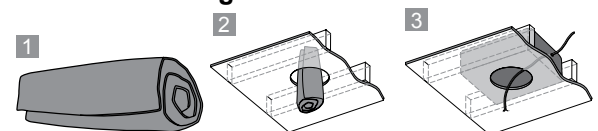

How is Commercial Audio Different?

The rules for residential audio, in most cases, don't apply for a restaurant, bar, or commercial building. The intended result is still good sound, but there are differences between commercial and residential design. With a residential system you are typically trying to please one or two listeners in a small area, while a commercial system must satisfy many listeners over a larger area. For example, a restaurant will have tables with people seated facing several different directions, so a system cannot provide a stereo image for all listeners.

Commercial systems are designed to overcome the issues that a residential speaker system cannot. For example, you can install a large number of speakers on very long daisy-chained wire runs with a 25V/70V system. Commercial systems use higher voltage to result in lower current when distributing power to a sound system. This allows longer runs without overheating or wasted current. 70 volt systems are the most common, and most energy efficient, but some local electrical codes limit low-voltage installers to 25 volt systems. Commercial systems should not be used in residences.

**STSP30PT****STBRC8****STSP-5MAT****STSP6AWXT****STG86TG****STTS-8**

25/70 Volt Speakers

STSP5MAT	5.25" commercial in-ceiling speaker, flame-retardant ABS, 2W - 60W, each	44.84
STSP6MAT	6.5" commercial in-ceiling speaker, flame-retardant ABS, 2W - 60W, each	53.33
STBRC6	In-ceiling bracket for SP5MAT and other 6" speakers, 8.375" cutout dim, pair	31.97
STBRC8F	In-ceiling bracket for SP6MAT and other 8" speakers, 9.875" cutout dim, pair	31.97
STSP6AWXT	6.5" all-weather design surface-mount speaker with transformer - black, 2.5W - 25W, pair	138.14
STSP6AWXTW	6.5" all-weather design surface-mount speaker with transformer - white, 2.5W - 25W, pair	138.14
STSP30PT	Hanging 5.25" pendant speaker with hanging chain - white, 2.5 - 30W, each	65.07
STSP30PTB	Hanging 5.25" pendant speaker with hanging chain - black, 2.5 - 30W, each	65.07
STSPG86T	8" Dual Cone Modern Grille Ceiling Speaker with Transformer, uses STBRC8F bracket, 1/4W - 5W, each	18.36
STSPG86TC	8" Dual Cone Modern Grille Ceiling Speaker with Transformer & Volume Control, uses STBRC8F bracket, 1/4W - 5W, each	24.48
STG86TG	8" Dual Cone Classic Grille Ceiling Speaker with Transformer, 1/4W - 5W, each	18.24
STTS8	Speaker ceiling support for G86TG, T-bar bridge for ceiling support of 8" speaker, top hat, & bracket, each	7.62
STSTH8	Top Hat, metal back box for 8" speakers, each	11.37

**STPL200M****STPVL30****STPFA****STPBM30**

25/70 Volt Commercial Amplifiers

STPVL15A	PVL-Series 15W amplifier, 2 mic inputs, and 1 AUX input	85.43
STPVL30A	PVL-Series 30W amplifier, 2 mic inputs, and 1 AUX input	111.66
STPBM30	Contractor Series 30W amplifier, 2 mic inputs, 1 XLR mic input, 1 RCA, telephone page input	159.50
STPMM60A	60W PA mixer power amplifier with 6 inputs	338.10
STPMM120A	120W PA mixer power amplifier with 6 inputs	445.89
STPL200M	160W, 5-source, 4-zone, matrix distribution PA amplifier	506.22
STPFA	Digital AM/FM tuner with 30 presets	186.98

Commercial Audio Accessories

STWAT50	50W, 70 volt, mono attenuator, single gang stainless steel plate	21.73
STMMB3XLR	3 channel XLR microphone mixer	69.07
STMUHF101	UHF 1-channel wireless receiver for microphone	189.10
STMUHFHH	UHF wireless handheld microphone	97.92
STMUHFLP	UHF wireless lapel microphone	97.92
STMCHH100A	Handheld dynamic microphone - wired	15.86
STMHL5S	Gooseneck adjustable desktop microphone, momentary talk switch can be locked down	60.08
STMCA20	20' microphone cable XLR connectors	20.48
STPAP160A	12" 380W self-contained portable P.A. system with built-in USB MP3 player and iPod® Dock	235.69

Designer-Style Infrared Receiver Kits (*B-Black, S-Silver, W-White)



XDL85K

XDL85K	LCD/Plasma/CFL Dinky Link kit. 80 foot range. Miniature stick-on.	110.16
XHL85*K	LCD/Plasma/CFL Hidden Link kit. 80 foot range. Shelf-top mount.	110.16
XML85K	LCD/Plasma/CFL Micro Link kit. 80 foot range. Barrel style.	104.92
XDL95K	LCD/Plasma/CFL Dinky Link kit. 120 foot range. Miniature stick-on.	153.00
XHL95*K	LCD/Plasma/CFL Hidden Link kit. 120 foot range. Shelf-top mount.	153.00
XML95K	LCD/Plasma/CFL Micro Link kit. 120 foot range. Barrel style.	155.63

IR receiver kits include IR receiver, connecting block, power supply and four emitters.

Designer-Style Infrared Receivers (*B-Black, S-Silver, W-White)



XDL85



XWL95

XDL85	LCD/Plasma/CFL Dinky Link receiver. 80 foot range. Miniature stick-on.	76.94
XHL85*	LCD/Plasma/CFL Hidden Link receiver. 80 foot range. Shelf-top mount.	76.94
XML85	LCD/Plasma/CFL Micro Link receiver. 80 foot range. Barrel style.	74.32
XWL85	LCD/CFL J-Box. Use when LCD TV's/CFL light is present. J-Box mount.	71.69
XDL95	LCD/Plasma/CFL Dinky Link receiver. 120 foot range. Miniature stick-on.	95.30
XHL95*	LCD/Plasma/CFL Hidden Link receiver. 120 foot range. Shelf-top mount.	95.30
XML95K	LCD/Plasma/CFL Micro Link receiver. 120 foot range. Barrel style.	155.63
XWL95	Plasma proof J-Box. Use when Plasma TV's/CFL are present. J-Box mount.	89.18

IR receivers require a power supply, connecting block and emitters to function.
DL85 and ML85 include Black, Silver and White color change kits.

Connecting Blocks



X789-44



X791-44



XCB12

X789-44	1-zone connection block: 4 emitter ports, requires power supply	26.67
X789-44PS/RP	1-zone connection block: 4 emitter ports, includes 781ERGPS	33.66
X789-44DW	1-zone in-wall connection block: 4 emitter ports, requires power supply	33.66
X790-00	1-zone, 10 emitter ports, emitters in parallel, requires 792-10 or 791-44	20.98
X791-44	1-zone amplified block, 10 emitter ports, connect up to 9 790-00's, requires PS	44.59
X792-10	Power booster module for Xantech receivers, requires PS	39.87
X793-10	Serial Control Combiner, combines IR serial data from up to 5 A/V receivers	39.87
X795-20	4 zones, up to 18 amplified emitter ports, 2 items per zone, 10 common, requires PS	113.91
X796-20	6 zones, expands 795 controller to a total of 9 zones	108.29
XCB12	1-zone block for mini plug IR receivers: 1 emitter port, terminals, requires PS	10.49
XCB18	Parallel Connecting Block: 1 in/8 out or 8 in/1 out	41.97
XCB20	1-zone connecting block for mini plug IR receivers: 2 emitter ports, requires PS	10.49
XCB60	1-zone connecting block: 6 emitter ports, one receiver port, requires PS	31.47
XZC21	2-zone connecting block: outputs-zone 1/2, common, input zone 1/2, requires PS	31.91

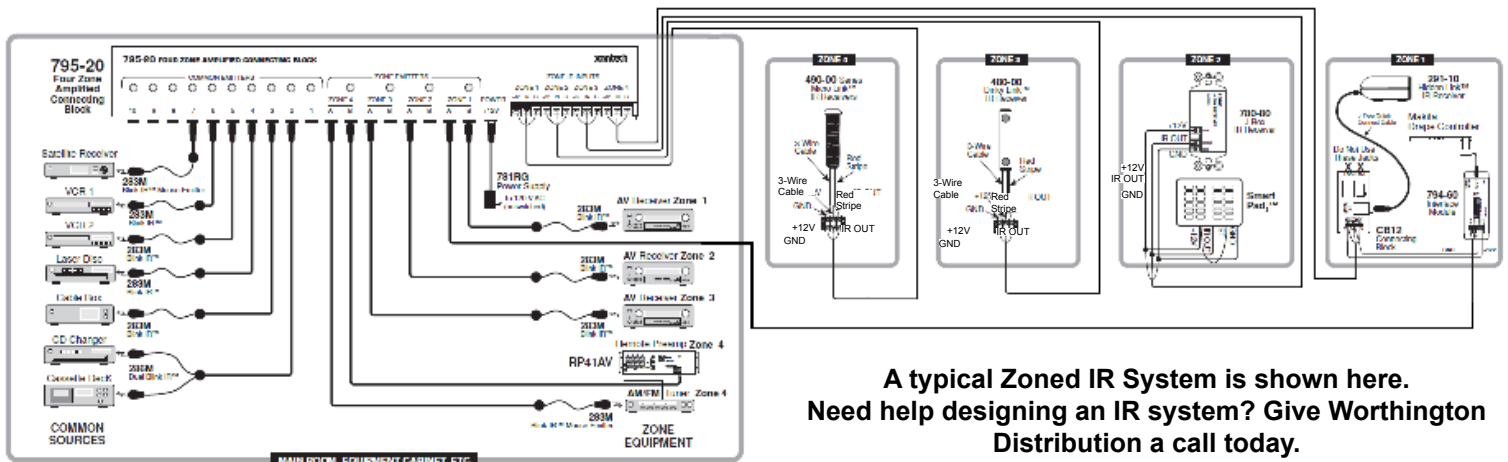

A typical Zoned IR System is shown here.
Need help designing an IR system? Give Worthington Distribution a call today.

Designer Infrared Emitters



		10-pk	5-pk	Each
X282D	Standard designer emitter, non-visible, 10' cable	70.82	N/A	9.18
X282TPD	Twin Plug mini designer emitter, dual plug - single emitter	N/A	N/A	9.18
X283D	Mini Blink-IR designer emitter, visible, low-output version, 10' cable	70.82	37.59	9.18
X283DPRO	Two-piece emitter, use with 283PROKIT to extend distance	N/A	N/A	9.18
X283DPROKIT	1ft., 3ft., 9ft. and 12ft. extension cables for 283PRO	N/A	N/A	10.49
X283TPD	Twin Plug Mini Blink-IR designer emitter, dual plug - single emitter	N/A	N/A	9.18
X284D	Dual mini emitter, non-visible, wire is 7' to junction, 3' to each emitter	80.44	N/A	9.62
X286D	Dual Blink-IR emitter, visible, wire is 7' to junction, 3' to each emitter	90.49	N/A	10.05
X28DES	Designer emitter shield cover, use to block interference	N/A	N/A	2.19

Power Supplies



X781ERGPS	Regulated 12VDC power supply, powers basic Xantech IR systems, uses 2.1mm coax plug			9.97
X782ERGPS	12VDC high-current power supply, powers large Xantech IR systems, uses 2.1mm coax plug			33.70

Modules



XIRX10	IR to X10 module, converts RC68X IR to X10 commands, requires PS, RC68X & DD4			69.51
XRS232IR	RS-232 to IR module, converts Xantech ASCII to IR codes, requires PS & DD4			199.34
XIRS232A	IR to RS-232 module with variable baud rate			227.82
XCBCSM1	Current sensor connecting block, requires CSM1 and 781ERGPS power supply			27.98
XCSM1	Current sensing module, requires CBCSM1 and 781ERGPS for stand-alone operation			61.23
XSMMAG01	Magnetic sensor module for ISM4. Provides status feedback for AC current in cords.			37.02

Smartpad3 Controllers



XPM110/RP	Dual gang Smartpad3 programmable module, prog. can be done w/ PM110 or DD4			191.75
XPM110KITRP	PM110 kit, includes (1) PM110, (1) MMD6, (1) MMDBZKIT, (1) CMD1 and (1) CMDBZKIT			240.63
XLM110/RP	Single gang Smartpad3 learning module, programming can be done w/ PM110 or DD4			106.79
XLM110KITRP	LM110 kit, includes (1) LM110, (1) MMD4 and (1) MMDBZKIT			159.47
XEM110/RP	Single gang Smartpad3 expansion module, must be used w/ PM110 to create 3 gang			56.83
XCMD1	Designer series cursor module, includes: keypad module with six function keys, four navigation keys, one selection key and 700+ button labels			39.87
XCMD4	Designer series four source cursor module, includes: keypad module with four source keys, two function keys, four navigation keys, one selection key and 700+ button labels			39.87
XCMD6	Designer series six source cursor module, includes: keypad module with six source keys, four navigation keys, one selection key and 700+ button labels			39.87
XCMDBZKIT	Designer series cursor module bezel kit, includes: 1 black, 1 ivory and 1 almond bezel			8.54
XKMD1	Designer series key module, includes keypad module with twelve function keys and 700+ button labels			39.87
XKMDBZKIT	Designer series key module bezel kit, includes: 1 black, 1 ivory and 1 almond bezel			8.54
XMMD1	Designer series master module, includes: keypad module with ten function keys, one rocker volume control key and 800+ button labels			40.34
XMMD2	Designer series two source master module, includes: keypad module with two source keys, eight function keys, one rocker volume control key and 800+ button labels			57.43
XMMD4	Designer series four source master module, includes: keypad module with four source keys, six function keys, one rocker volume control key and 800+ button labels			57.43
XMMD6	Designer series six source master module, includes: keypad module with six source keys, four function keys, one rocker volume control key and 800+ button labels			57.43
XMMD8	Designer series eight source master module, includes: keypad module with eight source keys, two function keys, one rocker volume control key and 800+ button labels			57.43
XMMD6BZKIT	Designer series master module bezel kit, includes: 1 black, 1 ivory and 1 almond bezel			8.54
XDTMSP3B	Desktop mount for Smartpad3 programmable controllers. For desktops, counters or tables. Black.			118.66
XDTMSP3W	Desktop mount for Smartpad3 programmable controllers. For desktops, counters or tables. White.			118.66

Programming and Controllers

X590-10	Programmable controller, use momentary contact closure to initiate IR, includes power supply	161.87
X598-00	Single-gang, 8-button keypad for 590, requires nine conductors, includes legend cutout sheet	58.85
X599-00	Pulsed switching module, provides low-voltage DC current to the 590, powered from the 590	42.72
XRC68X	IR remote programmer, use to program universal learning devices, req. 2 AA batteries (see page 13)	94.92
XISM4	The ISM4 eliminates the need for multiple remote controls. Simply walk up and press the power button on one of the devices. Automatic status control of up to 4 devices, 4 IR ports, 4 sensor inputs, bi-directional RS-232 port for status, can be used with all Xantech sensor modules, IR pass-through, XPS programming feature allows for programming without a PC. Includes power supply and (1) video sensor.	227.82



X590-10



XISM4

Cables and Accessories

X784-00	50' emitter extension cable w/ 3.5mm plug & jack on opposite ends, also works for IR receivers	5.22
X05913778	Programming cable: RS-232 to keypad	5.70
X6017400	1' mono cable - 3.5mm / 3.5mm plug, used to create a direct connection to devices	2.37
X6017440	Dual in-line adapter jack: female - female, 3.5mm mini	1.42
X6017450	10' Mono cable - 3.5mm / 3.5mm plug, used to create a direct connection to devices	3.32
X28ADJ	Infrared Adjuster, allows adjustment of IR output on any connecting block	8.74
X28EXT	External Emitter Adapter, use with IR input jacks on the back of A/V equipment	22.29
X634-00	Ground Breaker, connects to Cable boxes and Satellite receivers to eliminate "hum"	6.17
X28VHB	High Performance Emitter Tape, improves adhesion for rough installations	4.81



X6017450

Volume Controls

XRAT1	IR controlled remote autotransformer, controls audio level for 1 to 8 pair stereo speakers, requires RC68X & 782-00	150.93
XMIRV1W	IR/Motorized Infrared volume controller, use with RAT1 for IR controlled volume, white	83.93
XXVCD100	100W Rotary Impedance Matching Volume Control, decorator style	41.77



XRAT1

System Design Assistance

**Need help designing your IR system or have a unique application?
Give Worthington Distribution a call and let our expert technical staff guide you.
IR routing can be tricky, don't let it give you a headache! Give us a call today!**

Remote Control Switchers

X680-10	Remote AC switcher, 6 AC receptacles rated at 5A each, 15A total, outlets controlled individually or as a group, requires RC68X hand-held programmer	265.79
X686-10	Remote speaker switcher, 200W/channel capacity, requires RC68X & 782-00	226.63
XAC1	Controlled AC outlet, maximum switching current: 15A continuous @ 120VAC	77.36
XAC2	Controlled AC outlet w/ video input/output & delay, max. 15A continuous @ 120VAC	205.04
XCC12	Remote relay module, 1 DPDT relay rated at 5A, 30VDC, 2 normally open & 2 normally closed contacts, requires power supply and RC68X	94.92
XCC62	Remote relay switcher, 6 DPDT relays rated at 5A, 30VDC, 2 normally open & 2 normally closed contacts per relay, requires RC68X & 781RG	251.55
XRGC11	Remote gain control module w/ power supply, requires RC68X	94.92
XRT8	1x8 addressable IR router, requires power supply & RC68X	159.47
XRT16-10	1x16 addressable IR router, requires power supply & RC68X	256.29
XRS41AV	IR remote control A/V pre-amplifier w/ power supply, requires RC68X	93.68
XSR21	Remote A/B speaker relay module, rated 200W @ 8Ω, requires RC68X & 781RG	96.82
XRS2321X8	1 x 8 RS-232/RS422 serial router, requires power supply and RC68X	436.28



XCC12



XRS41AV



XRT8



XRS2321X8

Looking Xantech amplifiers and whole house audio? Give Worthington a call today!

M4 Audio Controller

PFM4 900.00

- 4-zone audio controller
- 6 source inputs
- Power: 30W x 8 channels
- Doorbell & telephone paging mute
- All digital amplification
- Includes 4 PMKIR master keypads w/IR
- Includes 6 IR Single Flashers
- Programmable via Proficient Editor software
- Dimensions (H x W x D): 5 13/16" x 17 1/8" x 15 1/2"
- Weight: 20 lbs

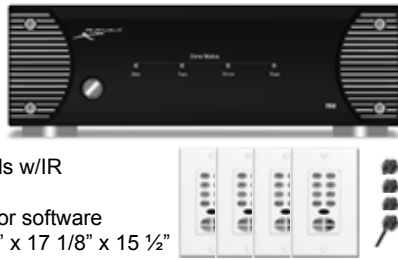

M6 Audio Controller

PFM6 1700.00

- 6-zone audio controller
- 6 source inputs + 2 AM/FM tuners
- Power: 30W x 12 channels
- Doorbell & telephone paging mute
- All digital amplification
- Includes 6 PMKIR master keypads
- Includes 6 IR Single Flashers
- Programmable via Proficient Editor software
- Dimensions (H x W x D): 5 13/16" x 17 1/8" x 15 1/2"
- Weight: 26 lbs



M8 8-Channel Power Amp

PFM8 500.00

- Power: 35 watts per channel @ 0.05% THD ±3dB
- High-Current discrete amplifier design
- Pass through output



The Source Keypad

PFPAS73331 300.00

The Source creates the ultimate media control experience by providing real-time system status, menu driven control options, and source metadata with its high-resolution color LCD. Order white or black. Black version includes black, bone & almond bezels.



M2 2-Channel Power Amp

PFM2 375.00

- Power: 125 watts per channel @ 0.05% THD ±3dB
- Amplifier stable to 2Ω
- High-current discrete amplifier design
- Pass through output



The Source iPod Dock

PFPAS73333 145.00

The Source Dock and The Source Dock Adapter provide an enhanced interface when used in conjunction with The Source keypad and M4 or M6. Universal style dock is compatible with most iPod® models. The Source Dock and The Source Dock Adapter ship together in one convenient package (every Source Dock requires a Source Dock Adapter). Linking Dock Adapters allows up to six Source Docks per system. Order in white or black.



The Source Power Supply

PFPAS73336 30.00 24V DC 2.5 Amp Power Supply for the Source Dock. Supports up to six Dock Adapters.

IR Devices

PFPAS80313	IR Shelf Top Kit, Shelf top receiver, Hub, Power Supply, 4 IR Flashers	80.00
PFPAS80315	IR Plasma Kit, Plasma receiver, Hub, Power Supply, 4 IR Flashers	132.00
PFPAS80312*	IR Mini Kit, Mini receiver, Hub, Power Supply, 4 IR Flashers	115.00
PFPAS80311	IR Fisheye Kit, Fisheye Hub, Router, Power Supply, 4 IR Flashers	118.00
PFPAS81205	IR Plasma Receiver	90.00
PFPAS82200	IR Hub	30.00
PFPAS85100	200 mA IR Power Supply	8.00

* - W for White, BK for Black



M4/M6 Parts and Accessories

PFPMKIR*	Master Keypad w/ IR, 8 source buttons (7 are programmable), includes extra labeled buttons	55.00
PFPMK*	Master Keypad, 8 source buttons (7 are programmable), includes extra labeled buttons	60.00
PFPFK*	Function Keypad, must be connected to PMK or PMKIR, 14 configurable transport buttons	32.00
PFPNK*	Numeric Keypad, must be connected to PMK or PMKIR, 16 configurable buttons	32.00

* Includes White, Bone, and Almond

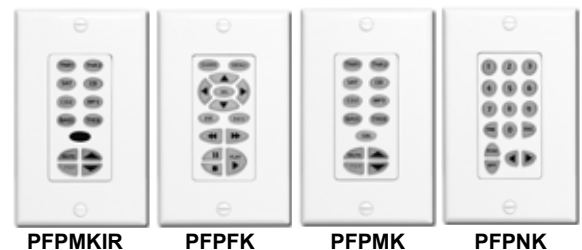

In-Ceiling LCR Speakers - priced each

PFC1030	LCR, 10" Kevlar Woofer, 3" pivoting Kevlar midrange, 1" pivoting aluminum tweeter, bass/treble contour switch, 200W, 15 degree angle, incl pre-construction bracket	275.00
PFC870	LCR, 8" Kevlar woofer, 1" coated aluminum pivoting tweeter, bass/treble contour switch, 175W, 15 degree angle	185.00
PFC660	LCR, 6 1/2" graphite woofer, 1" aluminum pivoting tweeter, 125W, 15 degree angle	120.00
PFC650	LCR, 6 1/2" polypropylene woofer, 1" silk dome pivoting tweeter, 100W, 15 degree angle	75.00
PFC655	One LCR ceiling speaker with woofer and tweeter bridge fixed at a 15° angle, 6 1/2" graphite woofer, 1" pivoting silk dome tweeter, and 100 watt power handling	100.00
PFC840	One LCR ceiling speaker with woofer and tweeter bridge fixed at a 15° angle, 8" graphite woofer and 1" pivoting silk dome tweeter, ±3dB bass & treble contour switches and 150 watt power handling	165.00



PFC1030



PFC840



PFC870



PFC650

In-Wall LCR Speakers - priced each

PFIW650	LCR, two 6 1/2" Kevlar woofers, 1" aluminum pivoting tweeter, bass/treble contour switch, 150W	225.00
PFIW625	LCR, two 6 1/2" graphite woofers, 1" soft dome pivoting tweeter, bass/treble contour switch, 125W	190.00
PFIW550	LCR, two 5 1/4" Kevlar woofers, 1" aluminum pivoting tweeter, bass/treble contour switch, 125W	150.00
PFIW525	LCR, two 5 1/4" graphite woofers, 1" aluminum pivoting tweeter, bass/treble contour switch, 100W	125.00



PFIW550



PFIW650

Center Channel Speakers - priced each

PFCC400	Cabinet Center, two 4" poly woofers, 1" aluminum dome tweeter, 85W	85.00
PFCC540	Cabinet Center, two 5 1/4" Graphite woofers, 1" aluminum dome tweeter, 100W	120.00
PFCC550	Cabinet Center, two 5 1/4" Kevlar woofers, 3" Kevlar midrange, 1" aluminum dome tweeter, 125W	160.00



PFCC550

In-Ceiling Speakers - priced per pair

PFC800TT	Single Point, 8" dual voice coil graphite woofer, twin 1" aluminum pivoting tweeter, bass/treble contour switch, 155W, each	120.00
PFC600TT	Single Point, 6 1/2" dual voice coil polypropylene woofer, twin 1/2" hard dome tweeter, 75W, each	65.00
PFC850	8" Kevlar woofer, 1" aluminum pivoting tweeter, +-3db bass/treble contour switch, 175W	260.00
PFC800	8" graphite woofer, 1" aluminum pivoting tweeter, bass/treble contour switch, 150W	215.00
PFC790	8" polypropylene woofer, 1" soft dome pivoting tweeter, 125W	145.00
PFC645	6 1/2" Kevlar woofer, 1" aluminum pivoting tweeter, bass/treble contour switch, 150W	210.00
PFC640	6 1/2" graphite woofer, 1" aluminum pivoting tweeter, bass/treble contour switch, 125W	170.00
PFC625	6 1/2" graphite woofer, 1" silk dome pivoting tweeter, 100W	125.00
PFC620	6 1/2" polypropylene woofer, 1" silk dome pivoting tweeter, 100W	115.00
PFC610	6 1/2" polypropylene woofer, 1" soft dome pivoting tweeter, 85W	90.00
PFC605	6 1/2" polypropylene woofer, 3/4" soft dome tweeter, 75W	70.00
PFC500	5 1/4" polypropylene woofer, 1/2" polyamide hard dome tweeter, 75W	80.00



PFC850



PFC640



PFC600

In-Wall Speakers - priced per pair

PFW850	8" Kevlar woofer, 1" aluminum pivoting tweeter, +-3db bass/treble contour switch, 175W	260.00
PFW800	8" graphite woofer, 1" aluminum pivoting tweeter, bass/treble contour switch, 150W	215.00
PFW690	6 1/2" Kevlar woofer, 1" aluminum pivoting tweeter, bass/treble contour switch, 150W	225.00
PFW680	6 1/2" graphite woofer, 1" aluminum pivoting tweeter, bass/treble contour switch, 125W	180.00
PFW670	6 1/2" polypropylene woofer, 1" silk dome pivoting tweeter, bass/treble contour switch, 100W	135.00
PFW665	6 1/2" polypropylene woofer, 3/4" soft dome tweeter, 75W	75.00



PFW850



PFW690



PFW665

Floor-Standing Subs - priced each

PFPS12	Subwoofer with 12" long excursion treated paper cone woofer and 250 Watt multi-voltage amplifier, slotted rear-firing port eliminates vent noise and distortion, black wood grain finish & chrome feet, LFE input, auto power	300.00
PFPS10	Subwoofer with 10" long excursion treated paper cone woofer and 120 Watt multi-voltage amplifier, slotted rear-firing port eliminates vent noise and distortion, black wood grain finish & chrome feet, LFE input, auto power	250.00
PFPS8	Subwoofer with 8" long excursion treated paper cone woofer and 80 Watt multi-voltage amplifier, slotted rear-firing port eliminates vent noise and distortion, black wood grain finish & chrome feet, LFE input, auto power	180.00



PFPS12



PFPS10



PFPS8

MaxTV MT2



The MaxTV MT2 is an awesome all-in-one system that lets you get great sound from TVs and smartphones. With dual 5.25-inch subwoofers, four midranges, and two tweeters, the MaxTV MT2 pumps out powerful sound—yet the whole unit slips right under a flat-panel TV. Connect via digital audio, analog audio or Bluetooth.

- Stereo down-firing 5 1/4" treated paper subwoofers
- Four 2 1/2" treated paper midranges
- Two 1" silk dome tweeters
- Inputs: RCA analog, optical and coax digital
- Bi-amped, 80W total amplification
- Frequency response: 35Hz - 20kHz
- Features Bluetooth® wireless technology
- Includes IR remote control
- Matte black finish
- Dimensions (H x W x D): 4" x 28" x 16 1/2"
- Wood-framed grille with neo-magnets

PFMT2	MaxTV MT2 Flat Panel Speaker System	375.00
-------	-------------------------------------	--------

Single Stereo Outdoor Speakers - priced each

PFAW600TT*	Single Point, 6 1/2" dual voice coil polypropylene woofer, two 1" Supernil soft dome pivoting tweeters, 150W	150.00
PFAW500TT*	Single Point, 5 1/4" dual voice coil polypropylene woofer, two 1" Supernil soft dome pivoting tweeters, 100W	115.00

*WHT for White, BLK for Black

PFAW500TTWHT



All Proficient outdoor speakers include swivel mounting brackets.

Outdoor Speakers - priced per pair

PFAW830*	8" polypropylene woofer, 3" graphite mid, 1" Supernil soft dome pivoting tweeter, 175W	275.00
PFAW650*	6 1/2" polypropylene woofer, 1" Supernil soft dome pivoting tweeter, 150W	200.00
PFAW525*	5 1/4" polypropylene woofer, 1" Supernil soft dome pivoting tweeter, 125W	150.00
PFAW400*	4" polypropylene woofer, 3/4" Supernil soft dome pivoting tweeter, 100W	115.00

*WHT for White, BLK for Black

All Proficient outdoor speakers include swivel mounting brackets.



PFAW830BLK



PFAW650BLK



PFAW525WHT



PFAW400WHT

In-Wall/Ceiling Sub System - priced each

PFPAS24100	10" in-wall long excursion treated paper cone woofer, inverted neodymium magnet, 250W	204.84
PFIWS82	8" in-wall long excursion treated paper cone woofer, inverted neodymium magnet, 200W	256.04
PFICS10	10" in-ceiling long excursion treated graphite woofer, inverted neodymium magnet, 175W	153.63
PFBB-IWS10	Wood Back Box for PFIWS100, MDF dampened to reduce translational energy to wall, fits standard 16" stud bay	100.00
PFM3	180W high-current mono amp with built-in crossover network, features adjustments for subwoofer fine-tuning to individual room acoustics, includes bolt-on rack ears	275.00



PFM3



PFIWS100

Rock Speakers - priced each

PFR650*	6 1/2" graphite woofer, 1" polyamide dome tweeter, 60W power handling	140.00
PFR800*	8" graphite woofer, 1" polyamide dome tweeter, 90W power handling	185.00
PFR800TT*	8" graphite woofers, 1" polyamide dome tweeters, 90W power handling	150.00

*- G for Granite, S for Sandstone

Signature Series

PFGL6	Bookshelf LCR, two 6.5" graphite woofers, 1" silk dome tweeter, gloss black finish, magnetic grille, 125W power handling	300.00
PFGS10	10" Sub, long-excursion pulp-composite cone woofer, 250W Class D amp, gloss black finish, magnetic grille	450.00



PFGL6

Volume Controls

PFVC60I	60-watt impedance-balancing volume control with autoformer, quick & secure wire connecting system, fits in most single-gang J-boxes and plaster rings, includes white, bone and almond plates, inserts and knobs	28.00
PFVC45I	45-watt impedance-balancing volume control with autoformer, features removable wire block terminal for easy connection, fits in most single-gang J-boxes and plaster rings, includes white, bone and almond plates, inserts and knobs	15.00
PFVCS60	60-watt stereo volume control with autoformer, features quick & secure wire connecting system, fits in most single-gang J-boxes and plaster rings, includes white, bone and almond plates, inserts and knobs	21.00
PFVC60SL	60-watt slider stereo volume control with removable screw down wire terminal design, fits in most single-gang J-boxes and plaster rings, includes white, bone and almond plates, inserts and sliders	33.00
PFVC60AW	60-watt weather-resistant volume control sealed against dust and moisture, fits onto 3/4" conduit or can be surface mounted, available in Gray	40.00



PFVC60I



PFVC60SL



PFVC60AW

Brackets and Back Boxes

PFPCB-IW500	Pre-Construction Bracket for IW550, IW525, each	15.00
PFPCB-C800	Pre-Construction Bracket for C790, C800, C850, C800TT, C850TT, C870, pair	15.00
PFPCB-C600	Pre-Construction Bracket for C605, C610, C620, C640, C645, C600TT, C650, C660, pair	15.00
PFPCB-C500	Pre-Construction Bracket for C500, pair	15.00
PFPCB-W800	Pre-Construction Bracket for W800, W850, pair	15.00
PFPCB-W600	Pre-Construction Bracket for W665, W670, W680, W690, pair	15.00
PFBB-C800	Metal Back Box for C790, C800, C850, C800TT, C850TT, C870, each	42.00
PFCTB-C600	Ceiling Tile Bracket for C605, C610, C620, C640, C645, C600TT, C650, C660, each	14.00
PFCTB-C800	Ceiling Tile Bracket for C790, C800, C850, C800TT, C850TT, C870, each	14.00
PFBB-C650	Metal Back Box for C605, C610, C620, C640, C645, C600TT, C650, C660, each	42.00
PFBB-W600	Metal Back Box for W665, W670, W680, W690, each	42.00
PFCMB-24	Mounting bars to attach BB-C650 to standard 24" ceiling joists, each	12.00



PFPCB-C600

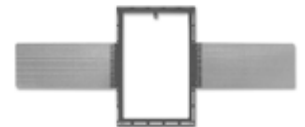

PFPCB-W600

Outdoor Speaker System



Outdoor Speaker System

New this year from Worthington Distribution is the SonArray system from Sonance. SonArray is made up of 8 satellite speakers and 1 in-ground subwoofer that shows 8 Ohms to the amp when wired. It can be powered by a standard A/V receiver, but since it runs on 20-100 watts, it's also compatible with Russound, HAI, or other whole-house audio systems. SonArray was first unveiled at CEDIA last year, and the demo was very compelling. The satellite speakers look like landscape lights, so they blend in well. They are also very directional, so place all 8 of them around the perimeter of your customer's patio facing in; they will get great, full sound without disturbing the neighbors!



DANSR1



SonArray comes in a presentable retail package. It's great for storefronts or even on-the-spot up sells.

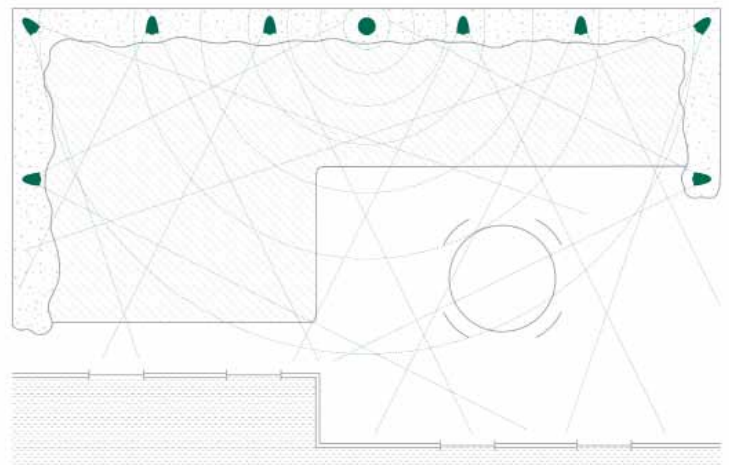

DANSR1 SonArray Outdoor Sound System, Bronze Color 1390.00

Allow Your Speakers to Perform to Their Maximum Potential

Sometimes you don't hear the difference between top quality speakers and generic models. Is the problem the speaker or the place it was installed?

Sometimes even the very best speakers don't sound their best when installed in a standard wall or ceiling structure. Without an enclosure system, sound resonates throughout the surrounding structure, creating muddy, back-wave distortion and unwanted noise and vibration to adjacent rooms. Dynamat's revolutionary enclosure systems dramatically improve sound quality and reduce unwanted noise to other rooms. In-wall and in-ceiling speakers now sound like speakers mounted in solid, well-crafted cabinets. Before you invest in top quality speakers, make sure you are installing them in a top quality location.

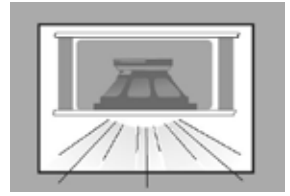
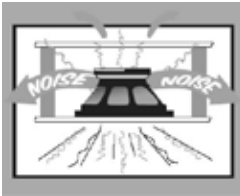

In-Wall Speaker Enclosures

En-Wall significantly reduces wall vibration, projects more clear sound into the room and reduces unwanted noise transfer through walls. It combines Dynamat Xtreme, DynaXorb and the SoundSnake to damp, diffuse, and decouple in-wall speakers. En-Wall encases in-wall speakers creating an optimal acoustic environment for delivering premium sound quality. En-Wall is an easy-to-retrofit speaker enclosure for in the wall. It reduces the sonic cancellations that are often created from in-wall speakers operating in long, shallow spaces. Kits for En-wall are available in single speaker packages for either 4" or 6" stud walls.



En-Wall Enclosure System

DYN50504	(1) 1.5" x 3.5" x 54" SoundSnake w/ Dynil (4) 6" x 6" DynaXorb (1) 12" x 18" Dynamat Xtreme (2) 4" x 10" Dynamat Xtreme	44.48
DYN50506	(1) 1.5" x 5.5" x 54" SoundSnake w/ Dynil (4) 6" x 6" DynaXorb (1) 12" x 18" Dynamat Xtreme (2) 4" x 10" Dynamat Xtreme	46.82

Ceiling Speaker Enclosures

DynaBox is a ceiling speaker enclosure. It completely encases the speaker, effectively reducing sound migration between ceilings and floors. DynaBox projects more clear sound into the room and reduces unwanted sound traveling outside the room. It is designed to be folded and is easy to retrofit.

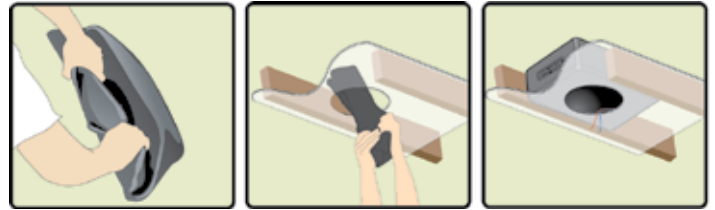

DYN50306	Kit includes: (1) DynaBox 17"x12"x6.5" (1) SoundSnake 1.5" x 5.5" x 54" (1) Back-Wave Foam 13.5" x 9" x 1"	79.61
----------	---	-------

Reduce Sound Created by Appliances

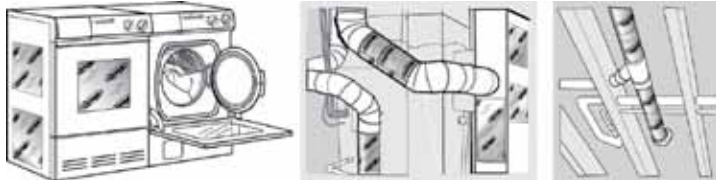

Unwanted noise produced by vibrating sheet metal is a common problem in every household. Dishwashers, air conditioners, duct work, and piping create irritating noise problems that keep you from enjoying music, movies and everyday family life. Many home theaters are also adding multimedia systems with metal enclosures that include fans. All these items are made from sheet metal and can be made quieter with an application of Dynamat Xtreme.

Dynamat Xtreme

DYN50400	Utility pack, (24) 4" x 10" pieces	51.50
DYN50455	Bulk pack, (9) 18" x 32" pieces	145.18

Application Note

**Quiet your Equipment Rack.
Reduce the sound of computers and DVRs.**

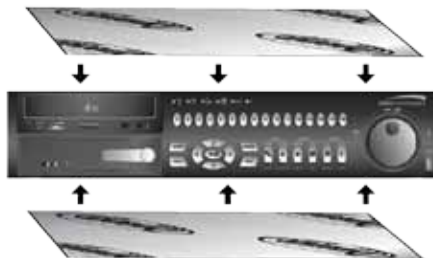

Don't block air vents! Cover as much surface area as possible.

Reduce Sound Through the Walls

Dynil is a dense, ultra-pliable acoustic barrier that reduces sound transmission through walls, floors and ceilings. Dynil works to prevent unwanted noise transfer outside the room while creating an optimal acoustic environment in the room.

Dynil makes any room quieter and is ideal for the home theater, office, nursery, exercise room, laundry room, bedroom, or home recording studio.

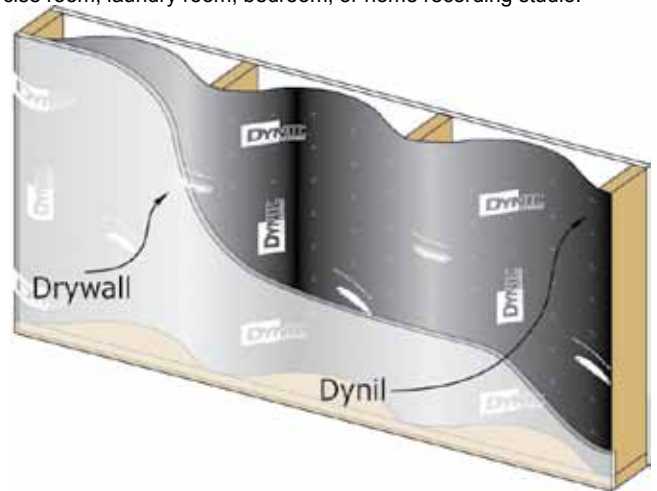

Dynil Sound Barrier

DYN50100	54 in. x 25 ft. long roll	440.25
----------	---------------------------	--------

Reduce Sound Through the Floors

DynaPad is an effective sound barrier that reduces sound transmission through floors. It can be used on any floor above or below to block outside noise and keep your theater sounds inside your theater. Installed under the carpet in the upstairs bedroom, DynaPad ensures a quiet sleep even if the kitchen dishwasher is running.

DynaPad Sound Barrier

DYN50110	54 in. x 25 ft. long roll	580.77
----------	---------------------------	--------

Keep appliance noise out of your TV room



HDMI Matrix Switchers

HDMI Matrix Switchers allow you to share multiple HD sources to multiple HD displays. Some units use standard wiring and some use a hybrid with Cat 5e. Control can also be passed over the same Cat-5e cable.



Pages 138-139



A/V Distribution

CE Labs audio/video products include distribution amplifiers, RF amplifiers, agile modulators and switchers. HDMI, component and composite splitters and distribution are available as well as scalers and matrix switchers.



Page 140



A/V Distribution over Cat 5e

MuxLab is a leading designer of value-added connectivity hardware allowing CCTV and audio-video equipment to be connected via cost-effective copper twisted pair. Today, almost any type of signal can be sent over Cat 5e using MuxLab baluns.



Page 141



Super IR Kit

Vanco's Super IR Kit or HDMI IR Control Kit allows you to use your existing HDMI cable to send IR signals from the TV location to the equipment location. No need to add additional wires. Save time and money for you and your customers.

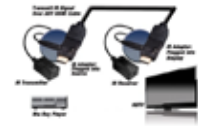

Call for Details



Matrix Switches

Matrix switches allow you to share multiple sources to multiple displays. Some units use standard wiring and some use a hybrid with Cat 5e.

See page 138-139 for Key Digital, 140 for CE Labs, and 120 for Russound.



Switches

Switches allow you to send multiple sources to multiple displays, however all displays show the same content.

Distribution Amplifiers

Distribution amplifiers allow you to take a single source and send it to multiple displays without quality loss.

See page 138-139 for Key Digital and 140 for CE Labs.

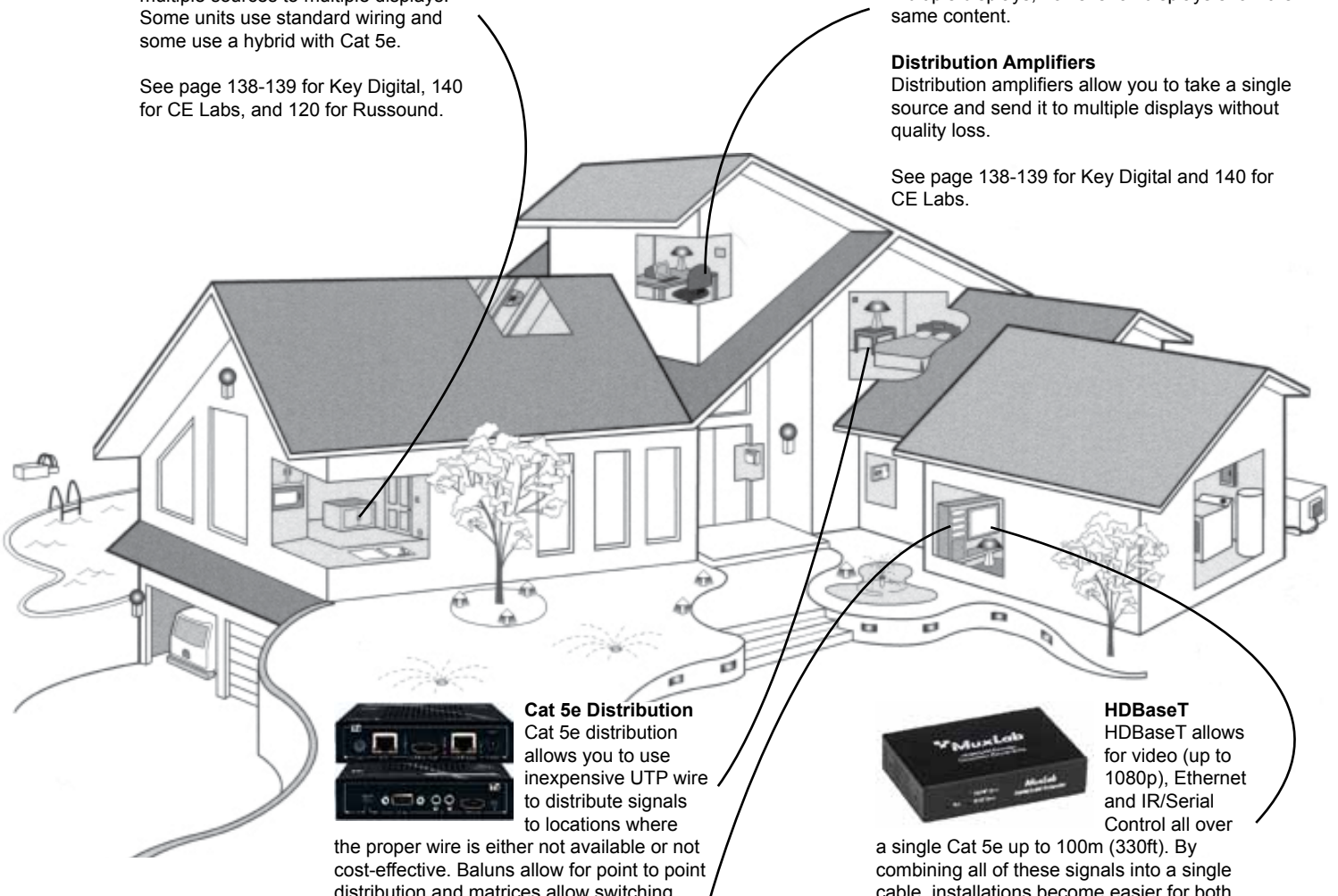

Cat 5e Distribution

Cat 5e distribution allows you to use inexpensive UTP wire to distribute signals to locations where the proper wire is either not available or not cost-effective. Baluns allow for point to point distribution and matrices allow switching.

See page 138-139 for Key Digital and 140 for CE Labs.



HDBaseT

HDBaseT allows for video (up to 1080p), Ethernet and IR/Serial Control all over a single Cat 5e up to 100m (330ft). By combining all of these signals into a single cable, installations become easier for both the installer and the homeowner.

See page 141 for MuxLab and 139 for Key Digital.

Compass Control



KDGKD-MC2500	Compass Control Master Controller	975.00
KDGKD-CSLX1	Compass Control Zone License	195.00
KDGKD-MC1500W*	iPad Wall Mount, hard-wired Ethernet, 7 hard buttons, fits iPad 2 and New iPad, * B-Black, W-White	TBD

The KDGKD-MC2500

Master Controller works as the control hub for the Compass Control® System. It has 12 I/O ports that allow IR, RS-232 and sensor control of the system and peripheral A/V components. In addition, the KD-MC2500 allows IR learning and has two sets of switchable contacts for relay control of external equipment.



- Fast and easy programming with Compass Navigator™ PC Editor and IntelliBuilder™.
- Built-in IR learning function enabling IR control of any device
- Complete control over audio, video, HVAC, lighting, shades, security, and more.

Compass Control® represents the first fully integrated major control system built from the ground up to use Apple's iOS devices – iPad®, iPad mini®, iPhone®, and iPod Touch® – as its backbone. Key Digital® engineers created Compass Control® to simplify a previously complicated process and provide one simple solution which can be set up in as little as one hour. Using Key Digital's Compass Navigator™ software, programming a Compass Control® device is an intuitive step-by-step process utilizing simple 'drag and drop' gestures. With the power of iOS and the Compass Control® App for the iPad®, iPhone®, and iPod® Touch, control for your dream system has become a reality thanks to simple swipe gestures and the simplicity of Compass Control's beautiful graphic interface.

In order to allow an iPad to be used as a controller for the system, it needs to be registered.

This process entails purchasing a registration license for each iPad to be installed, and then using the registration number to marry each iPad to this registration code. Once this is done, the iPad can be programmed for use in the system. The file is then generated in the Compass Navigator™ software, and it is uploaded to the Key Digital server where it is stored and then sent to the iPad upon launching the App. This makes it easy to update the program by sending an edited program to the server and having the App pull the new content whenever needed.



Available in white or black, the wallplate controller for iPad 2 and new iPad is the premier interface option for Compass Control. It permanently holds the iPad to the wall while adding hard buttons, wired power, and wired Ethernet to it.



Audio Devices



KDGKD-DAXAA	2-channel PCM Coaxial and Optical Digital to Analog L/R Audio Converter	52.50
KDGKD-AAXDA	Analog L/R Audio to 2-channel PCM Coaxial and Optical Digital Converter	52.50
KDGKD-MXA8X8PRO	8 In, 8 Out Audio Matrix Switcher, supports analog L/R & digital PCM	1575.00



KDGKD-MXA8X8PRO

Champion HDMI Cables

KDGKD-HIF11.5	VW1 Rated 1.5' HDMI Cable	7.00
KDGKD-HIF3	VW1 Rated 3' HDMI Cable	9.00
KDGKD-HIF6	VW1 Rated 6' HDMI Cable	11.00
KDGKD-HIF9	VW1 Rated 9' HDMI Cable	13.00
KDGKD-HIF12X	CL3 Rated 12' HDMI Cable	16.00
KDGKD-HIF16X	CL3 Rated 16' HDMI Cable	20.00
KDGKD-HIF20X	CL3 Rated 20' HDMI Cable	24.00
KDGKD-HIF30X	CL3 Rated 30' HDMI Cable	50.00
KDGKD-HIF40X	CL3 Rated 40' HDMI Cable	60.00
KDGKD-HIF150X	CL3 Rated 50' HDMI Cable	70.00



Champion Series

Working with HDMI signals can be complicated. Any installer who has dealt with the pitfalls of HDMI certainly knows that. They also know that there is no shortage of low-cost HDMI switching and transmission accessories that don't always get the job done well. With the Champion Series from Key Digital, you no longer need to sacrifice quality and performance for price. Champion has been designed to compete at the prices of the low-cost brands while still incorporating the features and performance that Key Digital is known for.

3D Ready - Capability to pass 3D stereoscopic signal formats
4K Resolution Support - 4096x2160/24 video resolution support
Light Buffer Technology - Multiple output viewing mode is supported by a dynamic realignment in clocking that may appear as a short blink when multiple displays/outputs select a single source/input. This dynamic re-clocking improves video quality on all displays and does not affect switcher performance during non-switching operation, built into matrix switchers
Wide Resolution Support - Supports all SD, HD, and VESA (VGA, SVGA, XGA, WXGA, SXGA, UXGA) resolutions up to 1080p (60Hz & 50Hz)
 »» SD & HD: 480i, 480p, 720p, 1080i, 1080p
 »» VESA / VGA (RGBHV): From 640x480p up to 1920x1200p
Supports lossless compressed digital audio - Dolby® TrueHD, Dolby® Digital Plus and DTS™-HD Master Audio

KDGKD-4X4	4X4 HDMI Matrix Switcher, IR/RS-232/ front panel control, supports lossless compressed digital audio, internal EDID library with 9 configurations	450.00
KDGKD-4X4XC	4X4 HDMI Matrix Switcher via Dual Cat 5e/6, simultaneous availability of HDMI and Cat 5e/6 outputs, IR/RS-232/ front panel control, supports lossless compressed digital audio, internal EDID library with 9 configurations, unidirectional IR routing adds up to 4 ports to control system	700.00
KDGKDCATHD4X4RX	Cat 5e/6 Receiver Baluns for above matrix, 75' max distance	140.00
KDGKD-4X1	4 In to 1 Out HDMI Switcher	120.00
KDGKD-2X1	2 In to 1 Out HDMI Switcher	100.00
KDGKD-1X4	1 In to 4 Out HDMI Distribution Amp	150.00
KDGKD-1X2	1 In to 2 Out HDMI Distribution Amp	120.00



KDGKD-4X4

KDGKD-4X4XC



KDGKD-4X1

KDGKD-1X2

Cat 5e/6 Baluns



KDGKD-CATHD100

KDGKD-CATHD150

KDGKD-CATHD100	HDMI via Dual Cat 5e/6, 1-way RS-232, 150' at 1080p, 3D ready, supports 4K	168.00
KDGKD-CATHD150	HDMI via Dual Cat 5e/6, 1-way RS-232, HDMI Ethernet channel, 150' at 1080p, 3D ready, supports 4K	196.00

HDBaseT Cat 5e/6 Baluns



KDGKD-CATHD500

KDGKD-CATHD300	HDMI via Single Cat 6, EDID control, RS-232 and IR support, 200' at 1080p, 3D ready, supports 4K	350.00
KDGKD-CATHD500	HDMI via Single Cat 6, EDID control, Ethernet, RS-232 and IR support, 300' at 1080p, 3D ready, supports 4K	560.00

HDMI Matrix Switchers



KDGKD-HD8X8

KDGKD-HD8X8XC

KDGKD-HD8X8	8X8 HDMI Matrix Switcher, 1080p, 3D ready, 4K support, control via IR, RS-232, TCP/IP, front panel	2975.00
KDGKD-HD8X8XC	8X8 HDMI Matrix Switcher, Dual Cat 5e/6 output, simultaneous availability of HDMI and Cat 5e/6 outputs, 1080p, 3D ready, 4K support, control via IR, RS-232, TCP/IP, front panel	3850.00
KD-CATHD150RX	Cat 5e/6 Receiver Baluns for above matrix, 150' max distance	116.78

HDBaseT HDMI Matrix Switchers



KDGKD-HD8X8BT

KDGKD-CATHD500RX

KDGKD-HD8X8BT	8X8 HDMI Matrix Switcher, HDBaseT single Cat 5e/6 output, simultaneous availability of HDMI and HDBaseT outputs, independent PCM audio and IR inputs/outputs, 1080p, 3D ready, 4K support, control via IR, RS-232, TCP/IP, front panel	7000.00
KDGKD-CATHD500R	Cat 5e/6 HDBaseT Receiver Baluns for above matrix, 300' max distance	315.00

Digital Signage - Still A Growing Market

CE Labs media players make it easy to offer Digital Signage solutions to your customers. Content can be created easily in PowerPoint and exported as video to the player. This means your customers don't need an expensive content service tied to their players.

Stand Alone HD Media Players

CELMP60	HD Digital Media Player, up to 1080p, plays content from USB stick (not included), HDMI/ Composite outputs, compact size	74.82
CELMP75	HD Digital Media Player, up to 1080p, plays content from USB stick (not included), GPIO inputs for interactive kiosk applications, HDMI/ Component/VGA/Composite outputs	124.78

Network HD Media Players

CELMP70	HD Digital Media Player, up to 1080p, Ethernet, 8GB SD card included, HDMI output, software included	286.02
CELMP500R	HD Digital Media Player, up to 1080p, Ethernet, 4GB CF card included, HDMI/VGA/Composite outputs, software included	437.03
CELMP700	HD Digital Media Player, up to 1080p, Ethernet, 8GB SD card included, dual screen support, web browser, HDMI/VGA/Composite outputs, software included	499.48



CELMP500R

CELMP60

Cat5 Distribution

CELCAT5TX	Transmitter, sends 1080i and SPDIF over 2 Cat 5e cables up to 300' (500' with Cat 6), connect to 2 receivers, 3 IR emitter ports	69.82
CELCAT5RX	Receiver, HD Component Video, SPDIF, IR Receiver port	79.81
CELC5-HDP	Passive HD Video Balun with SPDIF, 200' range, 1080i, buy one for each end	34.85
CELHM6EK-3	HDMI Extender Kit, use Cat 5e/6 to extend HDMI up to 160 ft, HDCP compliant	124.78
CELHM1CK-3	HDMI UTP Cat5e/6 Extender 328ft w/RS-232 & IR Pass-Thru	393.31
CELHX1K-3	HDMI UTP Single Cat5e/6 Extender 328ft	362.09
CELVG5EK	Cat5 VGA Extender Kit (w/RX and TX units)	137.27
CELVG5EKL	Cat5 VGA Extender Kit (w/RX and TX units) and LOOP through	149.76



CELCAT5TX

CELHM1CK-3

CELC5-HDP

HDMI Conversion Scalers

CELHSC12	HDMI In, Composite/S-Video, L&R Audio Out	109.79
CELHSC14	Composite/S-Video, L&R Audio In, HDMI Out - 720p or 1080p Selectable	109.79
CELHSC16	VGA & PC Audio In, HDMI Out	66.07
CELHSC20	Component Video, L&R Audio In, HDMI Out	66.07

HDMI Products



CELHA8-3

CELHM6EK-3

CELHA8-3	HDMI 1 In 8 Out Distribution Amp v1.3b with side entry and strain relief	287.15
CELHA4-3	HDMI 1 In, 4 Out Distribution Amp, HDCP compliant, can be cascaded 2 deep, features strain relief and securing clips	174.74
CELHA2-3	HDMI 1 In, 2 Out Distribution Amp, HDCP compliant	66.07
CELHM41SR	4x1 HDMI Selector Switch, auto source detection, RS-232 control, remote included	106.04

HD Switchers



CELSW204HD

CELSW808HD

CELSW204HD	4 Input, 2 Output High Definition Component Video Switch with SPDIF Digital Audio, RS-232 control, includes IR remote and rack ears	179.73
CELSW404HD	4 Input, 4 Output High Definition Component Video Switch with SPDIF Digital Audio, RS-232 control, includes IR remote and rack ears	999.08
CELSW808HD	8 Input, 8 Output High Definition Component Video Switch with SPDIF Digital Audio, RS-232 control, includes IR remote and rack ears	1623.58
CELHWS88C	8 HDMI In, 8 Cat6 out HDMI matrix switcher w/ IR, remote, and Cat6 Receivers	3934.23

HD and A/V Distribution Amps



CELAV501HDX

CELAV400COMP

CELAV400	1 In, 4 Out Composite Audio/Video Distribution Amp	37.47
CELAV700	1 In, 7 Out Composite Audio/Video Distribution Amp	47.46
CELAV400COMP	1 In, 4 Out HDTV/Component Audio/Video Distribution Amp	69.82
CELAV501HDX	1 In, 5 Out HDTV/Component Audio/Video Distribution Amp, Digital and L+R Audio	109.79
CELAV501HDXI	1 In, 5 Out HDTV/Component with Ground Isolation	199.72
CELAV901COMP	1 In, 8 Out with Loop Through HDTV/Component Audio/Video Distribution Amp	84.81
CELAV901HD	1 In, 9 Out HDTV/Component and Composite with Digital and Analog Audio A/V Distribution Amp	149.76
CELVG41DA	1x4 VGA Distribution Amp	74.82

For over 25 years, the MuxLab brand has been synonymous with quality, performance and reliability. MuxLab solutions streamline cabling by reducing material, space and installation costs. Even after installation, MuxLab products help save time and money by facilitating moves, adds and changes. MuxLab products are found in applications such as CCTV security and surveillance, classroom video, digital signage, home theatre, entertainment, podium presentation and boardroom projection systems just to name a few.

Audio-Video Baluns

MUX500050-2PK	RGB male & digital audio 1080i/p - 500' 2-pack	101.17
MUX500052-2PK	RGB male & analog audio 1080i/p - 500' 2-pack	101.17
MUX500058-2PK	RGB male & stereo audio balun 1080i/p - 500' 2-pack	166.93
MUX500054-2PK	Component Video/IR Pass-Thru Balun 2-pack.	101.17
MUX500001	Stereo audio-video balun - 2200' *	46.40
MUX500012	Dual audio-video balun - 1000' *	46.40
MUX500019	Analog audio balun - 5000' *	19.67
MUX500027	Stereo audio balun - 5000' *	30.91
MUX500028-2PK	Stereo Hi-Fi balun - 3250' *	65.76
MUX500033	Quad audio balun - 5000' *	46.40
MUX500039	Stereo Hi-Fi video balun - 2200' *	39.34
MUX500200	Audio-video distribution hub - 2200' *	446.58

* - When used with a DVR, maximum distance for video is 1,000 - 1,500 ft.



MUX500001



MUX500012



MUX500019



MUX500027



MUX500028



MUX500033



MUX500039



MUX500050



MUX500200

VGA Baluns



MUX500040



MUX500042

VGA balun II wallplates available, call for details

MUX500040	VGA balun II video balun PC side - 350'	39.34
MUX500042	VGA balun II video balun monitor side - 350'	56.20
MUX500040-42-PK	VGA balun II kit. Includes (1) MUX500040 and (1) MUX500042.	101.17

HDMI Over Cat5e/Cat6



MUX500401



MUX500402



MUX500401-WP-US



MUX500450



MUX500401	HDMI Econo Plus Extender Kit, up to 150ft**	181.35
MUX500402	HDMI Passive Extender Kit, up to 100ft**	151.13
MUX500405	HDMI IR-Extender Kit w/ IR, up to 300ft**	318.99
MUX500450	HDMI Mono Extender Kit w/ IR, up to 330ft	345.97
MUX500451	HDMI Econo Mono Extender Kit, up to 230ft	345.97
MUX500453	HDMI/LAN Extender Kit, up to 230ft**	345.97
MUX500460	HDMI Fiber Extender Kit, up to 1000ft**	345.97
MUX500401-WP-US	HDMI Econo Plus Wallplate Extender Kit, up to 150ft**	345.97

** Requires (2) Cat5e/Cat6 cables for maximum distance

HD-SDI and HD-CCTV Baluns



MUX500715



MUX500701

MUX500701	HD-SDI balun - 150'	181.35
MUX500715	HD-SDI to HDMI Extender Kit	542.07

Balun Accessories



WAV5E04UR**1	Cat 5e PVC 24AWG, 4 pair, CMR, 1000' Pull Box (BK, BL, GN, GY, OR, PK, PR, RD, WH, YL)	69.94
--------------	--	-------



WAV6E04UR**3	Cat 6 PVC: 23AWG, 4 pair, CMR, 550MHZ, 1000' reel in box (BK, BL, GN, GY, OR, PK, PR, RD, WH, YL)	114.91
--------------	---	--------



BL181279	6ft. M/M gold plated 1080p, CL3, 28AWG	2.27
BL181267	10ft. M/M gold plated 1080p, CL3, 28AWG	3.67
BL181290	30ft. M/M gold plated 1080p, CL3, 28AWG	15.50
PT100054C	EZ RJ-45 Heavy Duty Crimp Tool for Cat5/5e, Cat6 and RJ-11/12	65.16
PT100003C	EZ-RJ-45 Cat5/5e Connectors 50 pieces	0.47
PT100010C	EZ-RJ-45 Cat6+ Connectors 50 pieces	26.68
PTT119C	VDV MapMaster, test voice, video and data	81.15

See Page 116 for Muxlab CCTV Baluns

HDMI Cables



BL181278	3Ft. M/M gold plated 1080p, CL3, 28AWG	2.04	BL181290	30Ft. M/M gold plated 1080p, CL3, 28AWG	15.50
BL181279	6Ft. M/M gold plated 1080p, CL3, 28AWG	2.27	BL181294	50Ft. M/M gold plated 1080p, CL3, 28AWG	25.52
BL181267	10Ft. M/M gold plated 1080p, CL3, 28AWG	3.67	BL181296	60Ft. M/M gold plated 1080p, CL3, 28AWG	44.96
BL181268	15Ft. M/M gold plated 1080p, CL3, 28AWG	4.54	BL181276	75Ft. M/M gold plated 1080p, CL3, 28AWG	45.90
BL181269	20Ft. M/M gold plated 1080p, CL3, 28AWG	6.74	BL181277	100Ft. M/M gold ptd. 1080p, CL3, 28AWG	66.02

Component Video Cables



RCA M/M x 5

RCA M/M x 3

BL202170	3Ft. M/M Component Cable w/ Video/Audio	3.54	BL202180	3Ft. M/M Component Cable w/ Video	2.04
BL202171	6Ft. M/M Component Cable w/ Video/Audio	5.21	BL202181	6Ft. M/M Component Cable w/ Video	3.17
	N/A		BL202182	12Ft. M/M Component Cable w/ Video	5.39
BL202174	25Ft. M/M Component Cable w/ Video/Audio	18.87	BL202183	25Ft. M/M Component Cable w/ Video	10.73
BL202176	50Ft. M/M Component Cable w/ Video/Audio	38.61	BL202184	50Ft. M/M Component Cable w/ Video	19.43
	N/A		BL202185	75Ft. M/M Component Cable w/ Video	29.88

Miscellaneous Cables



Audio L/R			Composite		Digital Audio		RG59 BNC M		RG6 "F" Nickel		RG6 "F" Gold	
3 Ft	BL201801	0.53	BL201902	0.84	BL201601	1.48	BL202356	x.xx	BL202702	x.xx	BL202712	0.51
6 Ft	BL201802	0.65	BL201903	1.01	BL201602	2.04	BL202350	1.13	BL202703	0.66	BL202713	0.69
12 Ft	BL201803	1.24	BL201904	1.51	BL201603	3.28	BL202351	1.98	BL202704	0.99	BL202714	1.01
25 Ft	N/A		BL201905	2.40	N/A		BL202352	2.62	BL202705	1.58	BL202715	1.61
50 Ft	BL201805	3.09	BL201906	x.xx	BL201606	7.56	BL202353	4.02	BL202706	3.04	BL202716	3.06
75 Ft	BL201806	4.93	BL201907	7.11	N/A		BL202355	5.97	BL202707	4.81	BL202717	4.83
100 Ft	BL201807	6.32	BL201908	11.11	N/A		BL202354	7.92	BL202708	6.02	BL202718	6.05

PC Cables



SVGA M/M			SVGA M/F		VGA M/M (Ferrite)		VGA M/F (Ferrite)		DB9 M/M		DB9 M/F	
6 Ft	BL180441	3.67	BL180448	3.70	BL180455	3.83	BL180463	3.97	BL180211	1.20	BL180215	1.34
10 Ft	BL180442	4.67	BL180449	4.70	BL180456	4.37	BL180464	4.97	BL180212	1.61	BL180216	1.47
15 Ft	BL180443	6.01	BL180450	6.03	BL180457	6.28	BL180465	6.30	BL180213	2.24	BL180217	2.24
25 Ft	BL180444	9.18	BL180451	9.42	BL180458	9.53	BL180466	9.69	BL180214	3.01	BL180218	2.65
50 Ft	BL180445	15.24	BL180452	15.27	BL180459	15.51	BL180467	15.54	N/A		BL180219	5.67
75 Ft	N/A		BL180453	23.08	BL180460	23.33	BL180468	23.36	N/A		N/A	
100 Ft	N/A		BL180454	28.51	BL180461	28.76	BL180469	28.78	N/A		N/A	

Network Patch Cables



	Booted Cat 5E*		Non-Boot Cat 5E*		Shielded Cat 5E*		Booted Cat 6*		Non-Boot Cat 6*		Shielded Cat 6*	
0.5 Ft	BL100516	0.46	BL100416	0.45	BL100614	0.73	BL100716	0.78	BL100100	0.76	BL100816	1.48
1 Ft	BL100501	0.53	BL100401	0.51	BL100601	0.80	BL100701	0.85	BL100101	0.82	BL100801	1.63
3 Ft	BL100503	0.73	BL100402	0.73	BL100603	1.07	BL100703	1.17	BL100103	0.97	BL100803	2.24
5 Ft	BL100504	0.97	BL100403	0.96	BL100604	1.34	BL100704	1.38	BL100105	1.35	BL100804	2.85
7 Ft	BL100505	1.19	BL100404	1.17	BL100605	1.59	BL100705	1.73	BL100107	1.70	BL100805	3.46
10 Ft	BL100506	1.62	BL100405	1.61	BL100606	2.02	BL100706	2.17	BL100108	2.01	BL100806	4.41
15 Ft	BL100507	2.11	BL100406	2.09	BL100607	2.67	BL100707	2.86	BL100109	2.73	BL100807	5.89
25 Ft	BL100508	3.25	BL100407	3.24	BL100608	4.02	BL100708	4.27	BL100111	4.24	BL100808	8.92
50 Ft	BL100509	6.06	BL100408	6.05	BL100609	7.53	BL100709	7.38	BL100112	7.91	BL100809	16.83
75 Ft	BL100510	9.11	BL100409	9.10	BL100610	11.18	BL100710	11.74	BL100113	11.72	BL100810	25.06

* - Available in BK-Black, BL-Blue, GY-Gray, GN-Green, OR-Orange, PU-Purple, RD-Red, WT-White, and YW-Yellow

Leviton Architectural Edition

Leviton Architectural Edition

HOME ENTERTAINMENT SYSTEMS

BY

JBL

"9 OF 10 MAJOR LIVE CONCERTS ARE PERFORMED WITH JBL LOUDSPEAKERS"

"9 OUT OF 10 CERTIFIED THX® THEATERS USE JBL"

On-the-Wall Modular Home Theater System

JBL Systems measure up to a higher standard than typical home theaters because more JBL speakers are found in film recording studios and movie theaters than any other brand.

- Five-channel system that's expandable to 6.1 and 7.1 surround-sound operation with the addition of optional AES55 satellite speaker(s)
- Includes 5 architectural-grade adjustable mounting brackets
- Includes 8" - 100 Watt subwoofer and input RCA cable
- Video magnetic shielding provides the satellites the option to be located right next to a TV screen without causing any problems



LEVAEH50-*	On-wall or ceiling mounted (4) 2-way satellite speakers, (1) center channel, (1) powered sub- *Black or White	248.55
LEVAESS5-*	Additional satellite speaker for AEH50 - *BL-Black or WH-White	34.76

Home Theater Speaker Solutions

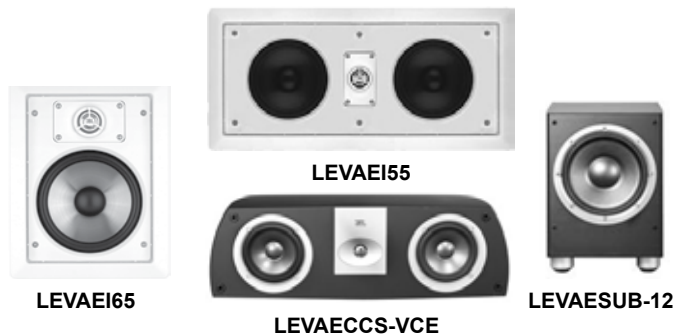

JBL built-in home theater systems are designed for custom installers and system integrators who need maximum flexibility and performance.

LEVAEI65	6.5" in-wall, 80W, 8 Ohm, pair	135.79
LEVAEI55	Dual 5" in-wall center channel, 120W, 8 Ohm, each	171.04
LEVAECCS-VCE	Dual 5" shelf-mount center channel, 300W 8 Ohm, each	117.51
LEVAEC65	6.5" ceiling, 80W, 8 Ohm, pair	111.70
LEVAESUB-12	Powered subwoofer, 12" woofer, 250W, each	309.99

Multi-Room Music In-Wall and Outdoor

LEVAEI65	6.5" in-wall speaker, 80W, 8 Ohm, pair	135.79
LEVAEC65	6.5" ceiling speaker, 80W, 8 Ohm, pair	111.70
LEVAEI80	8" in-wall speaker, 100W, 8 Ohm, pair	192.76
LEVAEC80	8" ceiling speaker, 100W, 8 Ohm, pair	168.34
LEVAEM65	6.5" DVC stereo, 100W, 8 Ohm, each	89.30
LEVAEN24	2-way weatherproof, 100W, 8 Ohm, pair	121.43

The JBL ceiling and in-wall speakers in the Leviton program feature JBL's famous EOS® waveguide technology used in professional sound systems.



LEVAEM65 LEVAEI65 LEVAEC65 LEVAEN24

Performance Accessories

DynaBox is a ceiling speaker enclosure. It completely encases the speaker, effectively reducing sound migration between ceilings and floors. DynaBox projects more clear sound into the room and reduces unwanted sound traveling outside the room. It is designed to be folded and is easy to retrofit.



See page 136 for in-wall speaker enclosures

DYN50306	Kit includes: (1) DynaBox 17"x12"x6.5" (1) SoundSnake 1.5" x 5.5" x 54" (1) Back-Wave Foam 13.5" x 9" x 1"	79.61
----------	---	-------

Pre-Wire Brackets and Accessories

LEVAEPC8-KIT	8" ceiling, pair	23.19
LEVPC55-KIT	6.5" ceiling, pair	17.39
LEVAEPI6-KIT	6.5" wall, pair	17.39
LEVAEPI8-KIT	8" wall, pair	23.19
LEVAEHTK	7.1 HT Interface plate	70.37
LEVAEPIS-KIT	Shelf for AEI55	33.82
WAVAC1402RWH15	14/2 Audio Cable, 14AWG, 500' box white	109.91
WAVAC1602RWH15	16/2 Audio Cable, 16AWG, 500' box white	72.44

See page 189 and 190 for speaker wire.

Audio/Video Receivers

SHRRD-5405	70W x 5.1 HDMI Switching Dolby Digital, 5 audio inputs and 2 audio outputs, 2 HDMI inputs and 1 HDMI output, 2 digital inputs, 5 surround modes.	136.00
SHRR-507	100W x 5.1 Channel HDMI 1.4 repeater with audio return channel, Dolby Digital, 2 A/V inputs and 2 A/V outputs, 2 composite video inputs and 2 composite video outputs, 3 HDMI inputs and 1 HDMI output, 2 analog inputs and 2 analog outputs, 3 digital inputs, MP3 and WMA decoding, pre-programmed IR remote control.	187.50
SHRR-607	100W x 5.1 Channel, Lossless audio, HDMI 1.4 repeater with audio return channel, Dolby Digital DPLII, 2 A/V inputs and 2 A/V outputs, 2 composite video inputs and 2 composite video outputs, 3 HDMI inputs and 1 HDMI output, 4 Analog inputs and 2 analog outputs, 3 digital inputs, MP3 and WMA decoding, 6 surround models. Pre-programmed IR remote control.	225.00
SHRR-807	100W x 7.1 Channel, Wi-Fi AVR, 2 Multi-source 2 zone, lossless audio, HDMI 1.4 repeater with audio return channel, Dolby Digital DPLIIZ, 2 A/V inputs and 2 A/V outputs, 2 composite video inputs and 2 composite video outputs, 5 HDMI inputs and 1 HDMI output, 4 analog inputs and 2 analog outputs, 2 digital inputs, MP3 and WMA decoding, 6 surround models. Pre-programmed IR remote control, internet audio, SmartPhone application iOS/Android.	324.00
SHRRD-7505	2-zone 100W x 7.1 Channel HDMI 1.4 repeater with audio return channel, Dolby TrueHD DTS-HD Master Audio, switchable from 7.1 to 5.1 for independent Zone 2 operation, 3 A/V inputs and 2 A/V outputs, 4 composite video inputs and 2 composite video outputs, 3 HDMI inputs and one HDMI output, 7 analog inputs and one analog output, 3 digital inputs Sirius Ready, 8 surround sound modes, preprogrammed IR remote control, Bluetooth ready.	300.00



SHRR-807



SHRRD-7505



SHRRD-607

See page 142 for HDMI and audio cables.

See page 150 for TV mounting options.

Stereo Receivers

SHRRX-4503	100W x 2, 2.1 surround sound, 6-channel direct audio input, Dolby Virtual speaker, Dolby headphone, switching for 4 speakers, tuner, 5 audio inputs, sleep timer, subwoofer preout, Bluetooth ready	133.00
SHRRX-5502	100W x 4 in multi-room mode, unified remote, multi-source, dual-zone capable for use as free-standing unit or as a zone 2/3 receiver/amplifier, Switching for four pairs of loudspeakers from the front panel or via remote control	145.00
SHRRX-4109	100W x 2, unified remote, phono section, switching for 4 speakers, tuner, 5 audio inputs, sleep timer	110.00
SHRRX-4105	100W x 2, unified remote, switching for 4 speakers, tuner, 5 audio inputs, sleep timer	90.00
SHRCDC-5506	5-disc CD player, front loading, MP3/WMA, USB input	155.00

iPod Docking Stations and Bluetooth for A/V and Stereo Receivers

SHRDS-10	Links iPhone, iPod touch, iPod classic, iPod Nano (gen 1, 2, & 3), iPod (gen 4 & 5), and iPod Mini to the audio receivers, component video output and on-screen display	67.00
SHRWD-1	Internet streaming appliance, built in Wi-Fi, DLNA or internet radio, Audio: MP3, WMA, Dolby Digital, Video: H.264, MPEG4, AVI, MKV, Photo: JPEG, PNG, GIF, BMP, SmartPhone application for iOS/ Android	91.00



SHRWD-1



SHRDS-N30

Sherwood Premium R-977



- Dual-zone, multi-source receiver
- HDMI 1.4 repeater 3D and ARC/CEC ready
- Apple AirPlay enabled, Wi-Fi adapter included
- Video scaling to 1080p
- Front HDMI and USB inputs
- Perfect for creating an inexpensive multi-room audio system

Free iOS and Android Application available!

SHRR-977	125W x 7 dual-zone receiver, HDMI 1.4 repeater with 6 in and 2 out; Video Scaling to 1080p; lossless audio including Dolby True-HD and DTS-HD Master Audio, Sirius ready, iPod ready, 4 A/V inputs and 3 A/V outputs, Anchor Bay video up-conversion to HDMI, 3 component video inputs, component video output, 8 analog inputs (including tuner), analog output, 4 digital audio inputs (2 coaxial and 2 optical), optical digital output, multi-stage dynamic range control, front panel USB and HDMI inputs, internet radio with vTuner, supports Windows 7 "Plays To."	749.00
----------	--	--------

RCS - Residential Configured Rack System

Middle Atlantic's RCS series of pre-built equipment racks include everything you need for a rack: a reversible glass door, pre-installed shelves, blank faceplates, casters, sides, rear panel, and venting fans. Even though every RCS Series rack includes shelves for convenient equipment mounting, they are built on a professional rackmount foundation and accept both professional rackmount and shelf-mounted consumer components.

RCS Series Compatible Accessories



Power Management - page 147



Rackmount Storage - see below



RSH Custom Shelves - see below



Cable Management - page 148



	MARCS-4224	MARCS-2724	MARCS-1824
Racking Weight Rating	1,200 lbs.	750 lbs.	500 lbs.
Shelves*	(5) 2 space, 16" deep (50 lbs.)	(4) 2 space, 16" deep (50 lbs.)	(3) 2 space, 16" deep (50 lbs.)
	(2) 2 space, 18" deep (50 lbs.)		
	(2) 3 space, 20" deep (100 lbs.)	(1) 2 space, 18" deep (50 lbs.)	
2 Space Blanks	9	5	3
Dimensions	24" deep x 23 5/8" wide x 80 1/2" high	24" deep x 23 5/8" wide x 54 5/8" high	24" deep x 23 5/8" wide x 38 5/8" high
Racking Height	42 space	27 space	18 space
MAP	1125.00	675.00	525.00

* Shelves and panels are pre-installed

RSH Series Custom Rack Shelves

Available in 2 different finishes, these easy-to-use shelves come pre-cut from the factory to fit the component that has been specified on the order. To order, call Worthington's 800 number and talk to one of our knowledgeable customer service representatives. Middle Atlantic provides a simple-to-use search tool to find the correct custom shelf (sample screenshot below). With a database of over 9,500 measured units, chances are your devices are listed. Non-listed products require a custom rack shelf request form.*

Base Model Numbers and Pricing

All custom rack shelves follow this MSRP pricing

		2-5 sp.	6-12 sp.
MARSH4A	Black Anodized Finish	172.42	192.70
MARSH4S	Black Brushed Finish	144.52	182.56

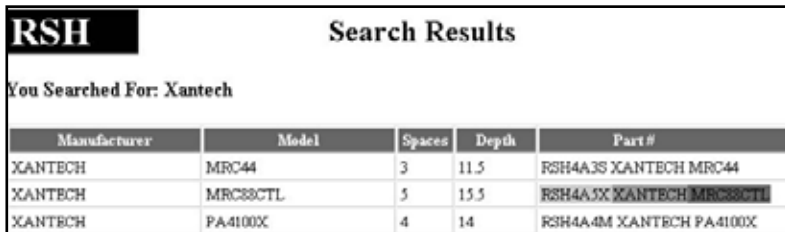

Screenshot: <http://repnet.middleatlantic.com/RSH/mainRSH.asp>

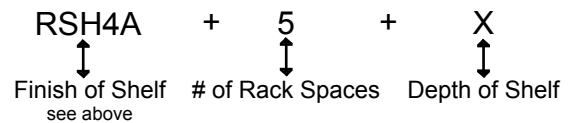

*Because these custom rack shelves are cut from dimensions provided by the customer, they are non-returnable/refundable. Only miscut shelves from the factory can be returned.

Rack Shelves and Drawers for Rack-Mount Equipment

Part Number	Description	MAP
MAU1	1 "U" up to 35 lbs. 10 3/4" deep	41.39
MAU2V	2 "U" up to 50 lbs. 14 9/16" deep	54.89
MAU3V	3 "U" up to 70 lbs. 14 9/16" deep	61.44
MAU4V	4 "U" up to 85 lbs. 15 1/2" deep	68.06
MAAS3-22	3 "U" heavy duty holds 500 lbs.	111.03



MAU2V/3V/4V



MAD2/3/4/5

Part Number	Description	MAP
MASH-SRSR	Zero space for SRSR rack	71.91
MAD2	2 "U" Drawer 14 1/2" Deep	148.38
MAD3	3 "U" Drawer 14 1/2" Deep	166.61
MAD4	4 "U" Drawer 14 1/2" Deep	178.04
MAD5	5 "U" Drawer 14 1/2" Deep	202.71

MAP prices are shown. Please call or login to the Dealer Store for aggressive dealer pricing.

SRSR Series Slide Out and/or Rotate Rail Rack

The SRSR Series extends a full 19" or 23," depending on model, and rotates 90 degrees. Great for in-cabinet mounting, the innovative SRSR system is available in a variety of sizes and accommodates up to 250 pounds. Providing enhanced access to rear connections, the unit locks in place at 0,° 60,° and 90° positions to ease installation and servicing. Each SRSR rack includes front and rear rackrails, an effective cable management system, locking panel, and hardware.

Key Benefits

- Pulls out and rotates for equipment servicing
- Removable rack frame allows in-shop integration and on-site installation of equipment, saving time in the field
- Simplifies equipment installation in cabinet
- Shortens installation and service time
- Available in 19" and 23" useable depths
- Integral cable management system provided
- Brush gasket fills unsightly gaps that may appear between the rack and custom millwork (requires a rough-in width of 19 5/8")
- Locks in place at 0,° 60,° and 90° positions for easy installation and servicing
- Ball bearing slides allow smooth rollout
- Locks closed with included hardware
- Up to 250 pound weight capacity, depending on model

Part Number	Sizes Available	Description	MAP
MASRSR-2-*	12-24 Sp. 19" deep	Two rail slide & rotate rails	516.77
MASRSR-4-*	12-24 Sp. 19" deep	Four rail slide & rotate rails	588.74
MASRSR-X-*	12-24 Sp. 23" deep	Four rail slide & rotate rails	742.50
MASRS2-*	8-20 Sp. 19" deep	Two rail slide out rails	433.70
MASRS4-*	8-20 Sp. 19" deep	Four rail slide out rails	520.43



Note: prices shown are for 12-space models. Call for other configurations.

BGR Series Gangable Rack Enclosures



MABGR-4527

BGR series racks have higher weight capacities, provide more useable rackspace, and incorporate more functionality than any other rack system on the market. BGR racks feature the patent-pending LeverLock™ system for tool-free installation of cable management accessories. Options include brush grommet, rear doors, and problem-solving extender bays. Choose a BGR enclosure for the highest level of space efficiency and strength available, and to take advantage of the latest options for installation flexibility.

Key Benefits

- LeverLock internal management system for cable management and device mounting within the rack
- Configurable top with generous 21" wide opening
- Optional cable entry rear door for easy cable routing
- More useable height - 45U in less overall height than most 44U racks
- LeverLock system can save up to 5U per rack by mounting small devices in "no man's land"
- High flow, low energy DC fan system uses less energy to move necessary airflow
- Rack designed with built-in thermal management features
- Optional curved front door (plexi or vented) for attractive installations
- Vertical trim kit has color accent choices for a distinctive look
- Static load capacity - 12,000 lbs, UL listed load capacity - 3,000 lbs.



MABGR with curved plexi door

Rack	Sizes Available	Description	MAP	Side Panels	MAP	Rackrail	MAP	Trim	MAP
MABGR-****	19-45 Sp. 27-38" deep	Gangable stand-alone rack	971.46	MABSPN-**-**	423.30	MABGR-RR**	104.64	MABGR-TRIM**	41.55

BGR Rack Front Door Options

Solid	MAP	Plexi	MAP	Vented	MAP	Curved Vented	MAP	Curved Plexi	MAP
MABFD-**	221.13	MABPFD-**	500.78	MABVFD-**	332.46	MAPFD-**A	543.32	MAPFD-**A	543.32

Pricing listed for 45 space, 27" deep rack. Call or login to our Dealer Store for more options and dealer pricing.

Active Cooling Solutions



MAUQFP-4RA



MAFTA-6



MAQB-2



MAUQFP-4DRA

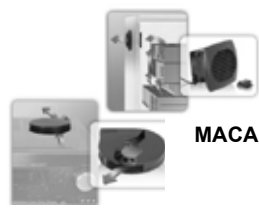

MACOMP-COOL



MACAB-COOL



MADUCT-COOL-1PT

MAQB-2A	Quiet blower panel, 100 CFM, 1 space	340.82	MACOMP-COOL-3	Component cooler set of 3	170.91
MAFTA-3	3 fan tray, 207 CFM, 1 space	295.70	MACOMP-COOL-E	Add 1+ fan to COMP-COOL3	45.84
MAFTA-6	6 fan tray, 414 CFM, 1 space	373.50	MACAB-COOL	Single fan, cabinet cooler	103.88
MAUQFP-4RT	4 fan panel, 100 CFM, 2 space, Black	215.36	MACLS-COOL1	Pass. intake, active exhaust	234.93
MAUQFP-4RA	Designer 4 fan panel, 100 CFM, 2 space	344.55	MACLS-COOL2	Active intake, active exhaust	284.76
MAUQFP-4DRA	Designer 4 fan panel with display, 2 space, Black	556.32	MADUCT-COOL-1PT	Duct Cool - 25 ft. of duct - 135 CFM	454.62
			MADUCT-COOL-2PT	Duct Cool - 25 ft. of duct - 293 CFM	558.30

MAP prices are shown. Please call or login to the Dealer Store for aggressive dealer pricing.

RackLink - Web Enabled Power Strips

RackLink power strips have an integrated web server and individually controlled outlets. Integrators can respond to simple power-cycle issues using a web browser or smartphone. RackLink strips can also be set to email a technician based on certain parameters like temperature, input voltage, load current and auto ping no response (routinely ping another network device). They can sense temperature in the rack and turn on auxiliary cooling if the threshold is exceeded. RackLink logs data for all measured parameters every five minutes, and on every alert condition. **Note:** Models with NS at the end have basic surge protection, otherwise they have 2-stage protection.

Part Number	Description	MAP
MARLNKMON115NS	In-line, 15A max load, 1 unswitched outlet	387.51
MARLNKMON120NS	In-line, 20A max load, 1 unswitched outlet	395.30
MARLNK-SW215-NS	In-line, 15A max load, 2 outlets (1 is controlled)	410.85
MARLNK-SW220-NS	In-line, 20A max load, 2 outlets (1 is controlled)	418.64
MARLNK-SW715R	Rackmount, 15A max load, 7 outlets (5 are controlled)	776.57
MARLNKSW715RNS	Rackmount, 15A max load, 7 outlets (5 are controlled)	761.01
MARLNK-SW620R	Rackmount, 20A max load, 6 outlets (4 are controlled)	807.69
MARLNKSW620RNS	Rackmount, 20A max load, 6 outlets (4 are controlled)	792.14



Vertical Power Strip 15 Amp Circuit with Cord and Plug

Part Number	Description	MAP
MAPD-615C	6 outlets, MOV surge protection, 26"	123.99
MAPD-615C-NS	6 outlets, breaker protection, 26"	105.83
MAPD-815SC	8 outlets, MOV surge protection, 18"	93.83
MAPD-815SC-NS	8 outlets, breaker protection, 18"	76.50
MAPD-1015C	10 outlets, MOV surge protection, 40"	141.90
MAPD-1015C-NS	10 outlets, breaker protection, 40"	129.44
MAPD-1415C	14 outlets, MOV surge protection, 57"	146.36
MAPD-1415C-NS	14 outlets, breaker protection, 57"	132.86
MAPD-2415SC	24 outlets, MOV surge protection, 60"	149.75
MAPD-2415SC-NS	24 outlets, breaker protection, 60"	131.87
MAPD-2X615	12 outlets, 2 X 15 amp circuit, 57"	139.70



Vertical Power Strip 20 Amp Circuit with Cord and Plug

Part Number	Description	MAP
MAPD-1020C-NS	10 outlets, breaker protection, 40"	201.00
MAPD-1220C-NS	12 outlets, breaker protection, 57"	217.28
MAPD-620C-NS	6 outlets, breaker protection, 26 1/2"	151.94



Single-Space Rack-Mount Power Strips, 15 Amp Circuit

Part Number	Description	MAP
MAPD-815R-PL	8 outlets, surge prot., flat black	97.59
MAPD-815RA-PL	8 outlets, surge prot., annod. black	205.44
MAPD-915R	9 outlets, surge prot., flat black	104.49
MAPD-915RV-RN	9 outlets, 2-Stage surge prot., flat black	163.17
MAPDS-615R	6 outlets seq. power strip, flat black	431.04



Vertical Power Strip 20 Amp Circuit with J-Box

Part Number	Description	MAP
MAPD-1020J-IG	10 outlets, J-box ISO ground, 44"	257.84
MAPD-1220J	12 outlets, J-box, 61"	185.76
MAPD-1220J-IG	12 outlets, J-box ISO ground, 61"	312.20
MAPD-2X620J	12 outlets, 2X20 amp circuit, J-box, 61"	208.67
MAPD-620J-IG	6 outlets, J-box ISO ground, 30 1/2"	220.88



Rack-Mount Strips, 15 Amp with Pop-Out LED Light Bar

Part Number	Description	MAP
MAPDLT-815RVA	8 outlets, surge prot., annod. black	278.39



Single-space Rack-Mount Power Strips, 20 Amp Circuit

Part Number	Description	MAP
MAPD-920R-NS	9 outlets, surge protection, flat black	193.68
MAPDS-615R	6 outlets sequenced, flat black	431.04

MAP prices are shown. Please call or login to the Dealer Store for aggressive dealer pricing.

EWR Series Sectional Wall-Mount Rack

The EWR Series 19" wall-mount rack provides unparalleled quality at an aggressive price when installing smaller systems in both secured and non-secured areas. These racks are ideal for installing rack-mountable products, such as distributed audio systems, in an out-of-the-way place on the wall.



MAEWR-10-22

Key Benefits

- Tool-Free Quick-Mount™ system allows for easy, one-person mounting of the center section to the backpan on the jobsite
- Welded construction provides 150 lb. weight capacity
- Available in 15" and 20" useable depths
- Center section hinges for left or right opening
- Abundant lacing points throughout the interior facilitate cable management
- 1/2", 3/4", 1" & 1 1/2" electrical knockouts and 5/8" UHF/VHF antenna knockouts on top and bottom, easily removable for cable pass-through
- 10 1/2" x 10 1/2" laser knockout opening in the backpan for electrical pull-box
- Durable black textured powder coat finish

Part Number	Racking Height (Spaces)	Weight Capacity	Overall Height	MAP
MAEWR-16-22	28" (16 spaces)	150 lbs.	35"	546.12
MAEWR-12-22	21" (12 spaces)	150 lbs.	28"	421.92
MAEWR-10-22	17" (10 spaces)	150 lbs.	24 1/2"	364.10
MAEWR-8-22	14" (8 spaces)	150 lbs.	21"	336.60

Products listed in 22" depth. Models are also available in 17" depth and with a solid door included.

EWR Rack Options

Solid Front Door	MAP	Plexi Front Door	MAP	Vented Front Door	MAP	Threaded Rackrail	MAP
MAFD-16	125.55	MAPFD-16	242.51	MAEVFD-16	177.48	MADWR-RR16	40.02
MAFD-12	114.15	MAPFD-12	223.88	MAEVFD-12	173.55	MADWR-RR12	32.94
MAFD-10	102.69	MAPFD-10	214.53	MAEVFD-10	163.68	MADWR-RR10	30.57
MAFD-8	82.85	MAPFD-8	193.43	MAEVFD-8	147.90	MADWR-RR8	28.22
MAEWR-ARB-17	17" Rackrail extender bracket		34.74	MAEWR-ARB-22	22" Rackrail extender bracket		39.59

Call or log in to our Dealer Store for more options and dealer pricing.

Cable Management



MALBP-LTF



MALBP-1R



MALBP-1A



MAHCM-1

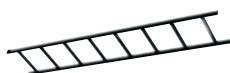

MACLB-6-12



MACLH-RSJ



MACLB-CSB-6

Part Number	Description	MAP
MACLB-6	Cable ladder runway, 12" W x 6' L, 1 piece	71.27
MACLB-90HB	90° horizontal bend, 12" W, 1 piece	126.00
MACLH-RSJ	Ladder end splice hardware, 1 pair	9.57
MACLB-CSB	Ladder support bracket w/ hardware, 1 piece	32.88
MACLH-ED11	Cable ladder, end drop, 11", 1 piece, 3 spools	59.57
MACLH-SD8	Cable ladder, side drop, 8", 1 piece, 3 spools	59.57
MACLH-WRS	Ladder wall support hardware, 1 piece	29.72
MALBP-1R	Lacer bar 10-pack, round rod style	52.95
MALBP-1A	Lacer bar 10-Pack, "L" shaped bar	33.90
MALBP-LTF	2-space lacer panel, multiple hole patterns	110.88
MAHCM-1	1 1/4" "Micro-clip" horizontal cable manager	26.72

Worthington Distribution has access to Middle Atlantic's entire line of products.

If the part you are looking for is not listed in our catalog, please call (800) 282-8864 for price and availability.

MAP prices are shown. Please call or login to the Dealer Store for aggressive dealer pricing.

Home Theater Series



Complete the home theater of your dreams with one of these HD projectors. With contrast ratios up to 4000:1 you will get a clear, crisp picture every time. If you have sources that are not HD, Worthington carries several products to upconvert them; this is also known as scaling. The HD66 is 3D ready!

****Q: How does DLP™ technology work?**

A: At the heart of every DLP™ projection system is an optical semiconductor known as the Digital Micromirror Device, or DMD chip. The DMD chip is probably the world's most sophisticated light switch. It contains a rectangular array of up to 1.3 million hinge-mounted microscopic mirrors; each of these micro-mirrors measures less than one-fifth the width of a human hair. When a DMD chip is coordinated with a digital video or graphic signal, a light source, and a projection lens, its mirrors can reflect an all-digital image onto a screen or other surface. The DMD and the sophisticated electronics that surround it are what we call Digital Light Processing™ (abbreviated DLP™) technology.

	Projection Distance	Native Resolution	Brightness	Contrast	Image	Lamp Watts	Lamp Life	
OPTHD20	4.92' to 32.8'	1080p (1920x1080)	1700 Lumens	4000:1	37.6" to 301"	230W	4000/3000 hours	691.90
OPTHD33	4.92' to 32.8'	1080p - 2D/3D	1800 Lumens	4000:1	37.6" to 301"	230W	4000/3000 hours	1307.90
OPTHD66	3.28' to 32.8'	720p (1280x720)	2500 Lumens	4000:1	27.2" to 301"	185W	4000/3000 hours	543.40

Worthington carries the full Draper line. Call for more information.



The goal in selecting the proper screen size is to make the screen large enough so those in the back row can read the subject matter easily, but not so large as to overwhelm the closest viewer.

- Aspect Ratio: HDTV formats, screen height should equal or exceed 1/3 the distance from the screen to the optimum seat. HDTV16:9, Widescreen 16:10, or 15:9.
- Width: Screen width is generally determined by the height of the screen and the projection formats to be used.
- Ceiling Height: The bottom of the screen should be approximately 40-48" above the floor in a room with a level floor and several rows of seats. In rooms with theater seating or only one or two rows, the bottom of the screen should usually be 24-36" above the floor. Evaluate any barriers and try to make sure that the lower part of the screen will be visible from all seats. Extra drop may be required to position the screen at a comfortable viewing level in a room with a high ceiling.

Clarion (Fixed/Permanently-Tensioned)

If motorized is not what you are looking for, take a look at these cost-effective wall/ceiling-mounted permanent screens. One-inch square, tubular aluminum frame creates a very clean, non-wrinkled viewing surface to enjoy your movies. Screens have 2" black vinyl borders. M1300 Finish listed.*



DR252139

DR252139	65" Screen, Size: 31.75" x 56.5" (16:9)**	477.40
DR252140	73" Screen, Size: 36" x 64" (16:9)**	504.90
DR252141	82" Screen, Size: 40.5" x 72" (16:9)**	561.00
DR252016	92" Screen, Size: 45" x 80" (16:9)**	639.10
DR252017	106" Screen, Size: 52" x 92" (16:9)**	796.40

*Other finishes are available. **Other formats avail. Call for information.

Luma 2 (Manual Non-Tensioned)

If you are looking for an affordable screen to get started in the home theater arena or have a customer that just wants a projection screen and does not want anything fancy, these are for you. Matte White Finish.*



DR206084

DR206084	92" Screen, Size: 45" x 80" (16:9)**	209.00
DR206085	106" Screen, Size: 52" x 92" (16:9)**	229.90
DR206080	119" Screen, Size: 62" x 108" (16:9)**	256.30
DR206046	133" Screen, Size: 65" x 116" (16:9)**	378.40
DR206021	161" Screen, Size: 79" x 140" (16:9)**	442.20

*Other finishes are available. **Other formats avail. Call for information.

Other screen types available. Call for more information.

Motorized Screen Control with HAI Omni

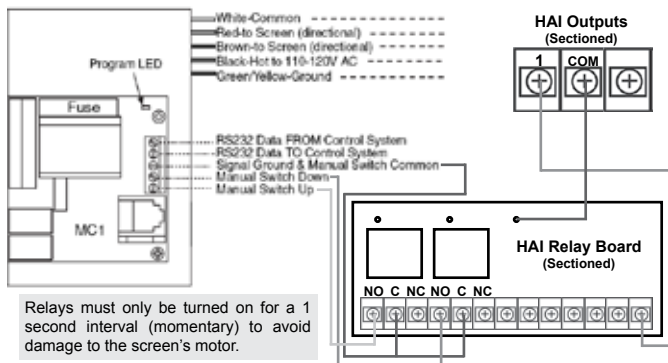

Relays must only be turned on for a 1 second interval (momentary) to avoid damage to the screen's motor.

DR121084	MC1 Motor Control Board	215.60
----------	-------------------------	--------

*Please read all instructions carefully and verify wiring.

Motorized Screen Control with Z-Wave - MAP Pricing

Integrate a motorized projection screen in a Z-Wave network. When you cannot run control wires to your screen location, you can add these modules to wirelessly control your motorized screen. Available in both AC and DC versions, these modules will accommodate the needs of most applications. For more options see page 34. For more Z-Wave devices, see pages 11-16.



ESIBMHZ

		MAP \$	Dealer
ESIDBMZ908	Z-Wave interface for low voltage 2-wire limit switch motors	217.00	Call
ESIBMHZ***908	Z-Wave interface for 3-wire limit switch motors	259.00	Call

*** = select voltage 115 - 115VAC, 230 - 230VAC

Projector mounts available. See Page 150.
When ordering mounts, please confirm proper part numbers.

Affordable Flat Panel Mounts from Worthington Distribution

Have you been priced out of installing home theater display mounts by big box stores? We have your solution. Worthington Distribution is your source for low-cost, high-quality flat panel display mounts. All of these mounts are made of 1/4" high-quality steel, have a black scratch-resistant coating, and include all of the hardware you need to hang most displays. We back up these mounts with a no-hassle return policy: if you purchase one of these mounts and are dissatisfied with the quality of the materials or the packaging, we will take the mount back. Best of all, purchase any four mounts from this page, and receive a fifth one free.



Mount	Size	Capacity	Adjustments	Hole Pattern	Profile	Price
BL502676	LED 23-50"	77 lbs.	Fixed	Universal 50x50mm to 440x440mm	0.2" (5mm)	25.98
BL502677	LED 26-65"	100 lbs.	Fixed	Universal 50x50mm to 640x640mm	0.2" (5mm)	27.81
BL502670	32-50"	100 lbs.	Fixed	Universal 50x50mm to 650x400mm	1.1" (28mm)	26.85
BL502671	36-63"	165 lbs.	Fixed	Universal 50x50mm to 800x400mm	1.1" (28mm)	32.40
BL502669	23-37"	77 lbs.	Tilts -5° to +15°	Universal 50x50mm to 450x300mm	2.36" (60mm)	31.80
BL502672	32-50"	100 lbs.	Tilts -5° to +15°	Universal 50x50mm to 600x400mm	2.36" (60mm)	36.90
BL502673	36-63"	132 lbs.	Tilts -5° to +15°	Universal 50x50mm to 800x400mm	2.36" (60mm)	42.75
BL502647BK	23-42"	88 lbs.	Tilts +10° pans and swivels	Universal 75x75mm to 420x237mm	3.7 to 22" (95 to 575mm)	76.26
BL502826	32-55"	110 lbs.	Tilts -5° to +15° pans and swivels	Universal 50x50mm to 600x400mm	4.5 to 22.5" (113 to 572mm)	101.85
BL502827	37-65"	132 lbs.	Tilts -5° to +15° pans and swivels	Universal 50x50mm to 800x400mm	4.5 to 22.5" (113 to 572mm)	119.40

Projector Mount



Mount	Capacity	Adjustments	Profile	Price
BL502664BK	Fits most small to large projectors up to 44 lbs.	Pitch ± 20° Roll ± 20° Rotate 360°	22.6 to 32.5" from ceiling	26.60

Additional Home Theater Accessories

De-Clutter with Residential Racks



Middle Atlantic has a new line of pre-configured racks which are priced to compete with the big box stores' off-the-shelf rack systems, while keeping Middle Atlantic's high standards of quality. These racks come with a reversible glass door, pre-installed shelves with blank face plates, casters, sides, rear panel, and venting fans to save you time in the field.

See pages 145-148 for more details.

Get Connected with Home Theater Cables

Don't forget the cables when you make your bid to your customer. Worthington Distribution can also be your source for high-quality, low-cost home theater cables. Our HDMI cables are Category 2 certified to support resolutions up to 1080p. We also have component video, coaxial, SVGA, and even composite cables to meet any home theater need.

See page 142 for more details.



Hide the Connections with a Recessed TV Box

Looking to keep a slim profile between the display and the wall? Plan to install an Arlington Industries TVB810 recessed TV box behind the display. This 8"x10" box comes with all of the hardware you need to set up a line-voltage outlet, a pass-through for your video cables, and even has a molded hanger to manage any cables which are longer than you need.

See page 185 for more details.



Control It All with a Mobile Device



With iRule you can offer full control of your customer's systems through a free app for their iPad, iPhone, Android, or Kindle Fire. iRule uses Global Cache devices to receive commands over the network from the app and translates them to IR or serial to control devices.

See page 47 for more details.



DSX Series Telephone Systems
NEC offers the DSX series of digital telephone systems. This lets you offer your customers a full intercom system that does not add wall clutter, while also providing a full telephone system with VoiceMail capability.



Page 152



Selective Call Intercom
A Cat5 intercom with station to station capability and color LCD displays at each station. Selective Call is easy to use and easy for a single technician to install. All that's required is connecting and naming stations.



Page 173



M&S DMC-10 Intercom
An affordable all-call Cat5 intercom. The DMC-10 is the most cost-effective intercom. Wiring is simple, and the line includes room, door, and patio stations, and even an audio input plate to provide background music.



Page 159



Message on Hold
When phone systems are used in a business application, message on hold is a great way for your customer to get their word out. With On Hold Plus systems, the customer can record their own message to be heard when callers are on hold.



Page 157



34-Button SuperDisplay
This is the premier phone for the DSX systems. We recommend at least one in every residential installation, placed in the most common area (usually the kitchen).

ommend at least one in every residential installation, placed in the most common area (usually the kitchen).



34-Button
The 34-Button is the most popular DSX phone. It offers plenty of configurable buttons that are backlit, plus a backlit dialpad. Use these in moderately-used areas.



Telephone System KSU
The brains of the operation. The KSU is where phone lines and phone stations are connected. It is mounted in the utility or media closet, and should be close to the structured wiring enclosure for easy connection.



Cat5 Intercom Station
Place intercom stations in frequently used rooms.



Cat5 Intercom Station
Most Cat5 intercom systems offer a single interior keypad style.



Cat5 Intercom Hub
Mounts in the structured wiring enclosure and connects to all stations.

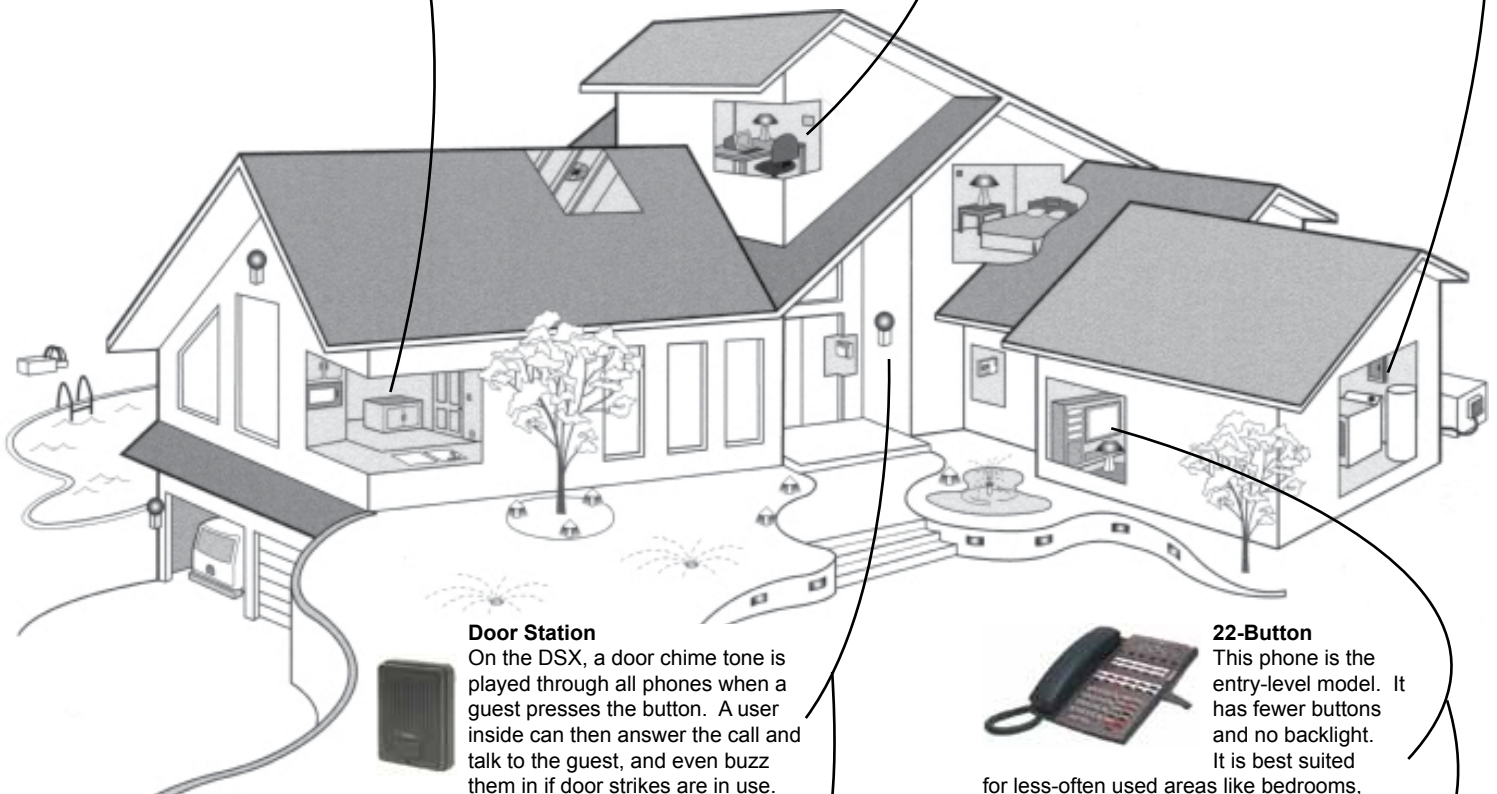

Door Station
On the DSX, a door chime tone is played through all phones when a guest presses the button. A user inside can then answer the call and talk to the guest, and even buzz them in if door strikes are in use.



Door Station
Cat5 intercoms offer a variety of door stations. Some have cameras integrated that can be connected for inside viewing.



22-Button
This phone is the entry-level model. It has fewer buttons and no backlight. It is best suited for less-often used areas like bedrooms, garages, and basements.



Cat5 Intercom Station
Selective Call from Legrand automatically orders the room list at each station by popularity.

Top Features

- All phones have 3-line or more LCD displays
- Fully digital extensions provide user guidance on the display for every feature
- Tri-Color LEDs on feature buttons make room monitoring and line sharing easy for users.
- IP phone capability - great for remote buildings, second homes, and tele-commuters
- Ethernet port enables network time synch and off-site programming
- Available IntraMail voice mail is easy to use and easy to configure



SIP-DECT Wireless Phones

NEC's ML440 SIP-DECT wireless handset system for DSX is great for any installer working on large systems, jobs with multiple buildings, or jobs that require a large number of wireless handsets. The Access Point (or base station) is a PoE network device. The handsets use DECT wireless technology to communicate to the Access Point and VoIP from there to the system.



When a job with multiple buildings comes up, place Access Points in each building (up to 8). Then register the required number of handsets (up to 32) into the system. Now the user can carry a handset anywhere on the property and have coverage.

Doorbox Features

A doorbox makes a great addition to a residential and even light commercial DSX installation. Doorboxes can be configured to chime all or select extensions. They make a distinct chime sound to notify occupants. When answered, the DSX user gets a button that can operate an on-board relay to release a strike or mag lock.



Leviton Security and Automation Integration

- Control lights, thermostats, buttons, audio zones, and arming from any DSX phone!
- Simply enter the Omni's IP address and Encryption keys in the DSX System Administrator software
- Create phone feature keys that bring up device lists, or that drill down directly to an individual device
- For buttons pointed to a specific lighting load, the lamp will indicate status of the related load
- Compatible with all three DSX phone models, but use the 34-Button Super Display for the best user experience



IP Features

IP extensions set the DSX apart from other systems in its category. Using digital keysets where possible and IP keysets in remote locations can provide an economical and very powerful system. DSX IP keysets look and operate exactly like the digital versions, so there is no learning curve for users.

Common IP applications:

- Digital keysets in a main office with IP keysets at remote branches
- Digital keysets in an office with IP keysets in the owners' home
- Digital keysets in a primary residence with IP keysets in vacation homes
- Smartphones as remote extensions

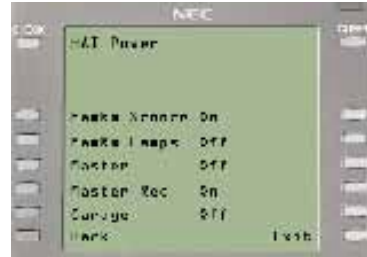

Leviton Security and Automation lighting devices shown on the 34 Button Super Display. Press the key next to any light to control it.

Leviton Security and Automation thermostat shown on the 34 Button Super Display. View status and control all setpoints and hold.

DSX System Administrator

The DSX System Administrator configuration tool makes system setup a breeze. All setup items are laid out logically and attributes from one station or line can easily be copied to another. Voice Mail is also configured from the same application.

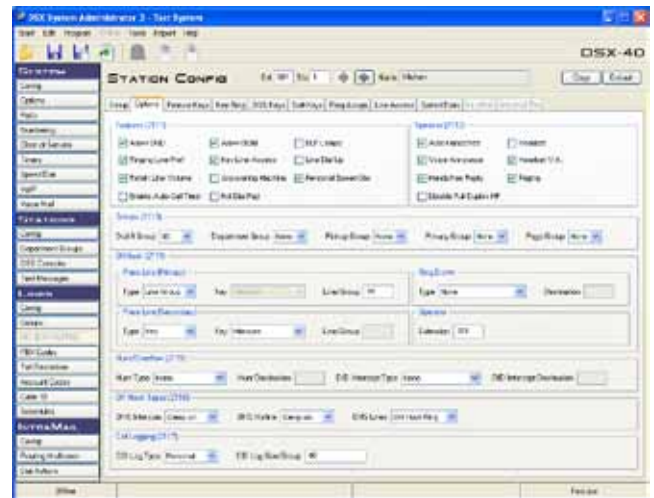

Go to worthington.com to see presentations and videos featuring the NEC DSX system. These free trainings will show you the features and benefits of the system, as well as programming tips.

Voice Mail

Have you steered away from voice mail in the past because of cost and complicated programming/installation? With DSX, it's no problem at all. The IntraMail system comes to you on a Compact Flash card that is inserted into the main cabinet. DSX recognizes it and makes it active.



Creating a single group mailbox is as easy as assigning all extensions to the same group. AutoAttendant menus are also easy to create.

DSX-40 Digital Telephone System with Available IP Extensions

Get the DSX-40 system with (3) 3-Line LCD telephones for only \$599!



The NEC DSX Series:

The DSX is a feature-packed PBX system that is at home in residential and commercial applications alike. With systems ranging from 3 lines and 8 extensions all the way to 64 lines and 96 extensions, the DSX has the capacity you need for a range of applications. DSX system phones are fully digital, meaning they have the ability to display far more dynamic information versus comparable analog systems. The LCD display always offers user guidance based on the feature key they press. IP capabilities offer the option of running stations over a network. This is great for customers with multiple vacation homes, remote buildings, and especially for offices with tele-commuters.



See the IP-based SIP-DECT wireless handset system on page 156. It lets you have multiple bases that handsets can hop between.

DSX-40:

4 Lines x 8 Digital Stations x 2 Analog Stations, expandable to 8x24x2, 8x16x10, or 8x8x18

Phones: DSX Digital and IP Phones, DSX DECT Wireless Phones, DSX 900MHz Phones, Standard Analog & SIP Phones

Features: All-Page, Station-to-Station Page, Music on Hold (external input, or via Mailbox), Voice Mail (optional CF card), Silent Room Monitor, Share Call to Multiple Stations

Interconnect: USOC 8-pin RJ-45 connectors on system, each color pair breaks out into a CO line, Station Port, or Door Box

NEC1090001	DSX-40 Cabinet, 4x8x2 (4 lines, 8 digital Extensions, 2 analog Stations), expandable, IP capable	368.98
NEC1091015	Kit includes (1) DSX-40 cabinet and (3) 22-Button phones in black (NEC1090020)	598.96
NEC1091026	Kit includes (1) DSX-40 cabinet, (3) 34-Button backlit phones in black (NEC1090021), and 2 port/8 hour Intramail	998.94
NEC1091027	Kit includes (1) DSX-40 cabinet, (3) 34-Button backlit phones in white (NEC1090026), and 2 port/8 hour Intramail	998.94
NEC1091001	4-port CO Card, max 1 per system	88.99
NEC1091002	8-port Digital Station Card, max 2 per system	78.99
NEC1091003	8-port Analog Station Card, max 2 per system	168.99

See below for VoIP expansion

NEC1091002



NEC1091001

DSX IP Phones and Hardware - VOIP Expansion

NEC1090034	34-Button IP Phone (IP version of NEC1090021), requires NEC1091045 power adapter or PoE	188.99
NEC1091045	IP Phone Power Adapter, used to power IP phone when PoE is not available, jacks: LAN in, phone out, LAN out	59.00
NEC1091044	DSX VoIP Daughter Board w/ 4-Port License, used in DSX-40/80/160	298.98
NEC1091046	4-port VoIP Expansion License, 1 max for DSX-40 for 8 total IP ports, 3 max for DSX-80/160 for 16 total IP ports	248.98
NEC1091028	VoIP Starter Kit, includes (1) VoIP daughter board, (1) 34-Button IP Phone, (1) DSX IP phone power adapter	498.97



NEC1090035



NEC1090034



NEC1091045

NEC1091044

DSX-80/160

- All the features of DSX-40 with added capacity
- Same programming software as DSX-40
- T1/PRI capability
- Card-based cabinet
- IP extension capability

NEC1091022	DSX-80 Common Equipment Kit (8x16), includes DSX-80 cabinet, power supply, CPU card, 8 CO card, 16 digital extension card	502.97
NEC1090002	DSX-80 4-Slot Cabinet	98.99
NEC1090003	DSX-160 8-Slot Cabinet	198.99
NEC1091008	DSX-80/160 Power Supply, (1) per DSX-80, (1-3) per DSX-160 - see load factor sheet	78.99
NEC1090010	DSX-80/160 CPU Card, one required per system	168.99
NEC1091009	DSX-80/160 8-port CO card	194.99
NEC1091005	DSX-80/160 16-port CO card	328.98
NEC1091006	DSX-80/160 T1/PRI card	899.94
NEC1091004	DSX-80/160 16-port digital station card	128.99
NEC1091010	DSX-80/160 8-port analog station card	228.99
NEC1091007	DSX-80/160 16-port analog station card	368.98

Larger Systems Provide New Opportunities:

Have you ever declined a phone system job over 24 stations? With NEC, there is no need to! The DSX-80 and 160 can support up to 64 CO lines and 128 stations. Since they use the same software as the smaller DSX-40, they are just as simple to set up. These larger systems also support T1 and PRI lines. Card-based cabinet makes service and expansion easy to carry out. Line and Station cards can be added or swapped without powering down the entire system. Like the DSX-40, the on-board Ethernet port means simple changes can be made to the system remotely. This means you can bill for service without even rolling a truck!



IntraMail and IntraMail Pro

- Configured with the same System Administrator software as the DSX system
- IntraMail is a Compact Flash card that is inserted into a DSX-40, 80, or 160
- Message Center allows group notification of new messages
- Record your own informative Message on Hold
- Conversation record and Live Call Screening
- Use IntraMail Pro to add E-mail notification of messages, FindMeFollowMe, cascading message notification, and web-based wake-up calls (great for small hotels)



NEC1091060	DSX IntraMail 2-Port/8-Hour Voice Mail – 128 Mailboxes	378.98
NEC1091011	DSX IntraMail 4-Port/8-Hour Voice Mail – 128 Mailboxes	498.97
NEC1091013	DSX IntraMail 8-Port/16-Hour Voice Mail – 128 Mailboxes	798.95
NEC1091051	DSX IntraMail Pro 4-Port/16-Hour Voice Mail – 128 Mailboxes	798.95
NEC1091053	DSX IntraMail Pro 8-Port/32-Hour Voice Mail – 128 Mailboxes	1198.92
NEC1091050	DSX IntraMail to IntraMail Pro Upgrade License	349.98
NEC1091048	DSX IntraMail/IntraMail Pro 2-Port Expansion License, expand an existing IntraMail or Pro up to a maximum of (8) ports.	174.99
NEC1091049	DSX IntraMail/IntraMail Pro 4-Port Expansion License - Expand an existing IntraMail or Pro up to a maximum of (8) ports.	324.98

When to Use IntraMail:

Residential Applications: IntraMail can be easily configured to operate similar to a simple answering machine, or to have a menu that directs callers to the appropriate mailbox. Individual members of the household often have their own mailboxes. Either way, it provides enhanced features. Each phone will notify users of new messages with a message lamp. Users may also choose to have a button configured to record messages during a call to a mailbox.

Commercial Applications:

Mailboxes are automatically configured for each user. Text screen guidance on each phone makes it easy for users to set up their greetings. Calls will forward to voicemail if unanswered or the user is busy. This is configured in software, leaving the Forward button available to the user to set up temporary forwarding.



DSX Door Stations

NEC922450	Door Intercom Station, charcoal, wires back to DSX using 2 conductors	44.76
NEC0891027	PGDAD Interface, adds 2 door station ports to a DSX-40/80/160, takes 1 digital port	72.73

- A guest presses the button on the door station and phones chime
- There are three chime sounds to choose from
- Chimes sound like an actual doorbell, not a ring
- DSX-40 includes 2 door station ports and 2 relays for door strike
- Use PGDAD adapter to add more door station ports to DSX
- Built on 1/4" thick metal plate
- 9 finishes to choose from
- 2 form factors available
- Weatherproof design



CVDP-0***P	NEC compatible door station, large form factor, includes surface mount box	169.86
CVDP-6***P	Same as above, has color camera built-in	261.25
CVIU-0***P	NEC compatible door station, 1-gang form factor, mounts in 1-gang box or mud ring	121.90
CVIU-6***P	Same as above, has color camera built-in	212.58

*** 212-white, 222-polished brass, 232-antique brass, 242-chrome, 252-oil rubbed bronze, 262-antique copper, 272-satin silver, 282-black, 302-satin nickel

DSX Digital Telephone Sets



NEC1090023



NEC1090021



NEC1090020

NEC1090020	22-Button Phone, 12 feature keys, 10 speed dial keys, 4 soft keys, 3-line display, black	98.99
NEC1090025	22-Button Phone, 12 feature keys, 10 speed dial keys, 4 soft keys, 3-line display, white	98.99
NEC1090021	34-Button Phone, 24 feature keys, 10 speed dial keys, 4 soft keys, backlit 3-line display, backlit dialpad, black	128.99
NEC1090026	34-Button Phone, 24 feature keys, 10 speed dial keys, 4 soft keys, backlit 3-line display, backlit dialpad, white	128.99
NEC1090023	34-Button SuperDisplay Phone, 24 feature keys, 10 speed dial keys, 12 soft keys, backlit 9-line display, backlit dialpad, full-duplex speakerphone, black	238.98
NEC1090024	60-Button DSS Console, black	148.99
NEC1090029	60-Button DSS Console, white	148.99
NEC1091054	Wireless Headset Adapter (WHA), attaches to 34-Button phones and enables seamless integration with Plantronics headsets, provides on/off-hook control without the use of a handset lifter	78.99

- 2-position desk mount (high or low angle) and wall mount, no need to remove desk stand when wall mounting
- Speakerphone (full-duplex on SuperDisplay models)
- LCD display with dynamic feature guidance
- Color-coordinated line cord included
- Tri-Color LEDs on feature keys offer user-friendliness when sharing lines or monitoring rooms
- Optional wireless headset adapter, great for commercial and home-office use
- DESI labels available and label software is free



Desi Labels

NEC1093085	DESI Labels for DSX 22Button	(For Black Tels)	Pkg/20	12.50
NEC1093083	DESI Labels for DSX 34B	(For Black Tels)	Pkg/20	12.50
NEC1093081	DESI Labels for DSX Super Display	(For Black Tels)	Pkg/20	12.50
NEC1093079	DESI Labels for DSX 60B DSS	(For Black DSS)	Pkg/20	12.50
NEC1093086	DESI Labels for DSX 22B	(For White Tels)	Pkg/20	12.50
NEC1093084	DESI Labels for DSX 34B	(For White Tels)	Pkg/20	12.50
NEC1093082	DESI Labels for DSX Super Display	(For White Tels)	Pkg/20	12.50
NEC1093080	DESI Labels for DSX 60B DSS	(For White DSS)	Pkg/20	14.88
NEC1093072	DESI Labels for DSX 22B	Blank	Pkg/25	12.50
NEC1093071	DESI Labels for DSX 34B	Blank	Pkg/25	12.50
NEC1093070	DESI Labels for DSX Super Display	Blank	Pkg/25	12.50
NEC1093069	DESI Labels for DSX 60B DSS	Blank	Pkg/25	12.50

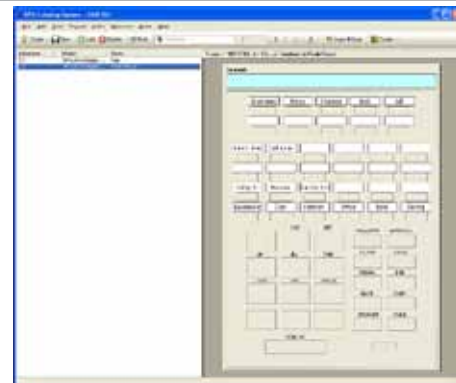

DESI labels replace the blank button labels that come on the phone. You can use the free software to label each button's function.

Wireless Headsets and Adapter



NEC1091054

Convertible Headset System



PLA84693-01



PLA83542-01



The Wireless Headset Adapter (WHA) is a great tool for any user who spends extended periods of time on calls. It connects to 34-button DSX phones and interfaces to select Plantronics wireless headsets. The WHA opens up the benefits of a wireless headset without having to use a handset lifter.

NEC1091054	Wireless Headset Adapter, use on 34-Button and 34-Button Super Display phones	78.99
PLA84693-01	CS540 DECT 6.0 Wireless Headset System, 300' range, includes communication/charging base and convertible (over the ear, behind the head, over the head) style headset with boom mic	237.46
PLA83542-01	Savi 700 W740 DECT 6.0 Wireless Headset System, 300' range, includes communication/charging base and convertible style headset with noise-canceling boom mic, can also connect to PC and mobile phone	299.32

ML440 SIP-DECT Cordless Phones

ML440 Handset



NEC730650

AP20 Access Point



NEC730651

NEC730653	Bundle, includes (3) ML440 Handsets with Chargers and (1) AP20 DECT Access Point	899.94
NEC730650	ML440 DECT Handset with Charger, requires at least (1) AP20 DECT Access Point	244.98
NEC730651	AP20 DECT Access Point, PoE compatible, requires SIP Daughter board to be installed in system	389.98
NEC1091044	DSX VoIP Daughter Board w/ 4-Port License	298.98

SIP-DECT Facts

- Phones use DECT to communicate with Access Point, then use VoIP from there to the system. These are IP phones.
- A Single AP20 Access Point can handle 30 registered handsets and 10 simultaneous calls.
- Up to 20 AP20s can be used on a system with a total of 32 handsets registered. In this configuration, each AP20 can handle 8 simultaneous calls.

SIP-DECT Applications

- Installations that call for more than three wireless phones
- Installations that require a large coverage area
- Installations that include multiple buildings. For example, a company with an office and separate warehouse building. Since the Access Point is a network device, simply deploy them in each building and users can carry an ML440 handset anywhere on the site and be covered. The same applies to residential applications with multiple buildings like a main house and a guest house.

Multi-Cell Application Example

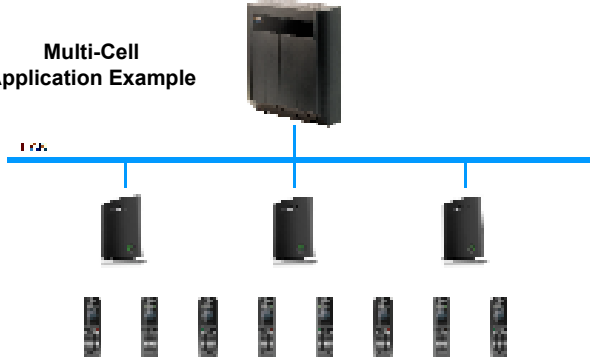

Single-Cell Application Example

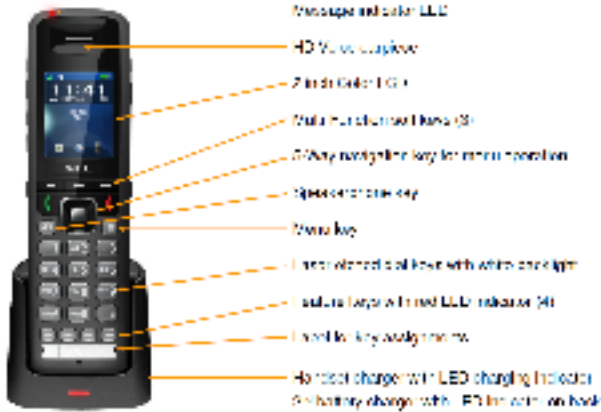
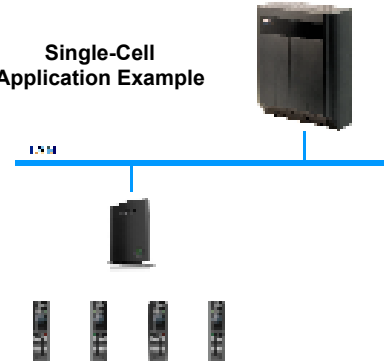

SIP-DECT vs. Standard DECT

When should I use the standard DECT phones (shown below) and when should I step up to the ML440 SIP-DECT?
 Strictly from a cost perspective, the standard DECT wireless phones are most cost-effective when using up to three. If you need more than three, the SIP-DECT become more cost-effective. Even if you need 3 or less wireless phones but need to cover a large area, the ML440 is a better option. It allows up to eight base stations to be connected to a system, and all the cordless phones can hop from base to base as the user moves throughout the structure.

DSX Standard Wireless System Telephones

NEC730095	DECT Cordless Phone, DECT 6.0 1.9GHz technology provides outstanding range, 8 programmable buttons w/ LEDs, includes phone, charger base, DECT base, belt clip, base has in and out ports for pairing with desk station	324.50
NEC730649	DECT Repeater, use when greater coverage is needed, needs power only, no system connection	164.99



NEC730095

NEC's DECT wireless system telephone is a great addition to any DSX system. Its backlit LCD display and dial buttons make it easy to use. Eight feature keys give the user access to many of the same features that a desktop phone has. The DECT wireless phone is known for its outstanding range. On the largest installations, repeaters can be used to extend the range even further. They require only AC power and do not wire back to the system cabinet, so they can easily be added after the initial install.

Message On-Hold Players

OHP 8000 Features:

- Ready to go - Right out of the box. Pre-loaded with nearly 3 hours of fully licensed music & messages.
- Free on-hold production personalization - provided automatically when product is registered
- Rugged extruded aluminum enclosure with wall mounting capability
- 128MB USB flash drive included (preloaded with music and "thanks for holding" messages)
- Works with any ordinary USB Flash drive
- Built-in monitoring speaker
- Trigger switch input
- MessageStudio On-Hold Audio Creator Software
- 3-Year warranty



MessageStudio Software

The OHP 8000 includes our award-winning, simple-to-use MessageStudio Software. With MessageStudio, you're just a few mouse clicks away from your own, professional-sounding, custom on-hold audio presentation. You'll be surprised at just how quick, fun and easy it is to sound like a Fortune 500 company.

ITOHP8000	USB Music On-Hold Player, works great with NEC phone systems, great attachment item on phone system jobs	171.11
-----------	--	--------



Commercial Background Music System with Streaming Music Content



EOS Streaming Music Player

The new EOS streaming music system is built for background music in an office or other business. The EOSP-500 media player streams 50+ channels of music from the Cloudstream service (\$29/month) through an ordinary Ethernet connection. Cloudstream music is fully licensed to be played in public areas. Connect directly to any distribution amp or add the EOSP-510 wireless transmitter card to the EOSP-500 to send your music wirelessly to up to 8 EOS wireless powered speakers (EOSP-622) or the EOS wireless receiver (EOSP-610). Robust wireless performance of up to 300 ft.

Features

- Streaming internet music player for business • Ethernet connection
- Includes 60-days of free licensed business music from Cloudstream Music (50 music channels) • Line outputs to distribution amp • Supports wireless music playback to EOS wireless speakers & receivers with optional integrated wireless audio transmitter card (EOSP-510)
- Built-in flash drive player (Zone 2) can be used for music-on-hold or second music channel • SD card slot for music backup - activates in event of internet failure • Built-in monitor speaker • Backlit LCD display
- 10-station presets • IR remote control • Dual-zone volume controls
- Switchable mono & stereo outputs • 1-year warranty

ITEOSP-500	Streaming Media Player	Call
ITEOSP-510	Wireless Transmitter for above player	Call
ITEOSP-610	Wireless Transmitter/Receiver	Call
ITEOSP-622	Powered Wireless Speakers	Call
ITEOSP-05	Optional Speaker Wall Mount Kit	Call

EOS Wireless Powered Speakers

The EOS Wireless powered speakers are a perfect solution for most any application. Integrated power supply allows the speaker to mount onto any wall outlet without additional installation, or use the optional wall mounting bracket (EOSP-05) for other installations.

Features

- Integrated wireless receiver
- Class D 25W digital amp
- Integrated speakers (4" woofer and 1" tweeter)
- Ported bass reflex cabinet • Zone 1 or 2 select switch • Right/Left channel switch • IR remote with volume and tone control • Up to 300' wireless range • High-gain antennas • Optional wall mounting kit (EOSP-05) • Incredible sound quality



EOSP-610 w/optional mounting bracket

EOS Wireless Transmitter/Receiver

The EOSP-610 has some great residential applications. In receiver mode, it can be used to send line-level audio from one location to another, then amplify and play it through traditional speakers. In transmit mode it can send audio from any source to the EOS wireless powered speakers or another EOSP-610 in receive mode.



EOSP-610

On a Russound MCA-C Series, wire a variable line level output from a zone to the EOS transmitter. Use EOS wireless speakers in areas that could not be wired. The customer can control that zone from the Russound iPad app for a totally wireless experience.

Features

- Mode Select Switch (transmit or receive) • Zone Select Switch (Zone 1 or 2) • High gain 1/4 wavelength antennas • Line Level Zone 1 & Zone 2 stereo or mono input/outputs • Zone 2 impedance selector switch (8Ω or 600Ω output for MOH) • Up to 300' wireless range • Wall Mountable
- 1 Year Warranty

ACNC DoorBell Fon Door Answering System Kits

1. Simply remove the doorbell button and replace it with the door speaker. Only two wires are required.
2. Install the controller where all of the phone wires are connected.
3. Connect the incoming line to the terminals marked "telephone" and connect all phones to the terminals marked "phones."
4. Find the doorbell wire and connect it to terminals marked "door station 1" or "2." DoorBell Fon can handle two door stations.
5. Press the button and the phones will ring with a distinctive ring; pick up the phone and you are connected to the door.



ACNCDP38NBF



ACNCDP28NIT

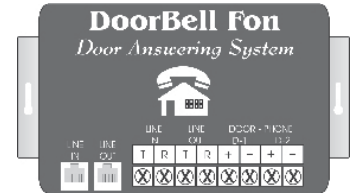

ACNCDP28C

ACNCDP28IT	DoorBell Fon door answering system w/ surface-mount ivory door box. Rings up to five phones in the home three times when door station button is pressed. Just pick up your phone to talk to the person at the door. Connect up to two door stations. Usually, no new wiring required - uses two-conductor wire already at the doorbell. Includes controller, power supply and door speaker.	138.64
ACNCDP38*F	Liberty Style DoorBell Fon door answering system w/ flush-mount-Solid Brass, use 2-gang masonry box	193.60
ACNCDP28*F	Standard Style DoorBell Fon door answering system w/ flush-mount-Solid Brass, use 2-gang masonry box	193.60
ACNCDP38SF	DoorBell Fon door answering system w/ flush-mount-Brushed Aluminum, use 2-gang masonry box	193.60
ACNCDP38BXFS	Surface Mount backbox for flush mount stations	14.99

* = B-Solid Brass, S-Brushed Aluminum, BK-Black, BZ-Bronze

Door Boxes and Accessories * = B-Solid Brass, S-Brushed Aluminum, BK-Black, BZ-Bronze

ACNCDP28NIT	Surface-mount door box, used to add second station-Ivory	47.46	ACNCDP28NBF	Liberty Style Two gang flush-mount door box, add second station-Brass	102.42
ACNCDP38NBF	Liberty Style Two gang flush-mount door box, add second station-Brass	102.42	ACNCDP28NBKF	Liberty Style Two gang flush-mount door box, add second station-Black	102.42
ACNCDP38NBKF	Liberty Style Two gang flush-mount door box, add second station-Black	102.42	ACNCDP28NBZF	Liberty Style Two gang flush-mount door box, add second station-Bronze	102.42
ACNCDP38NBZF	Liberty Style Two gang flush-mount door box, add second station-Bronze	102.42	ACNCDP28NSF	Liberty Style Two gang flush-mount door box, add second station-Brushed Aluminum	102.42
ACNCDP38NSF	Liberty Style Two gang flush-mount door box, add second station-Brushed Aluminum	102.42			
ACNCDP29CI	Door chime interface, used to ring existing door bell as well as phones	49.96			
ACNCDP29SW/IM	Door strike controller for DoorBell system/intercom module	47.46			



ACNCDP28NBF



ACNCDP28NBZF



ACNCDP28NSF



ACNCDP38NBKF



ACNCDP38NBZF



ACNCDP38NSF

Door Strike/Intercom Module Wiring

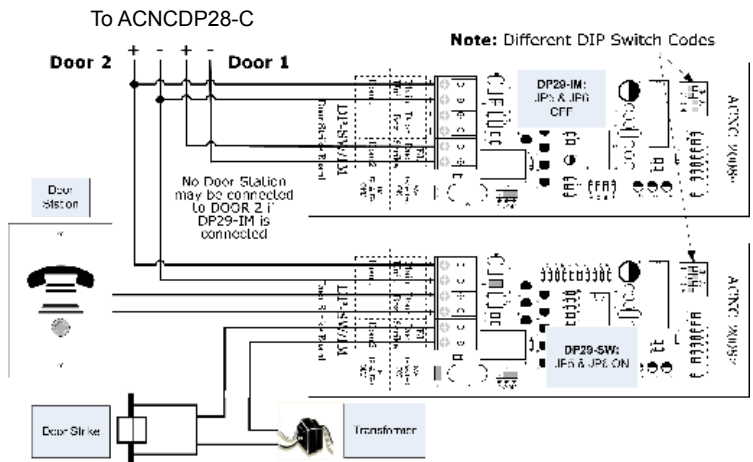

Replacement Intercom Solution for Existing 3 and 4 Wire Systems

The Model DMC3-4 Music/Communication Retrofit System Master is a full-function intercom and music distribution system designed for retrofit applications. The master unit can replace older intercom systems that use 3-wire or 4-wire connections to the room stations. The system supports up to 15 room stations and up to three door speakers. The built-in AM/FM radio tuner allows setting eight AM station presets and eight FM station presets. The backlit liquid crystal display shows the operation mode, audio source, radio frequency, volume setting, and time. With the optional Model DMC1 iPlay® dock installed below the master unit the system provides three different media playback options: CD player, a dock port for your portable device, and an audio line input for other MP3 devices.



MSSDMC3-4



MSSDMC1MM

MSSDMC3-4*	Retrofit intercom with built-in AM/FM radio tuner	453.25
MSSDMC1MM*	Add-on iPlay® Dock - MP3 & CD Changer	437.61
MSSDMC3RS*	3-wire retrofit room station with remote scan and master volume	64.47
MSSDMC3RW	3-wire retrofit patio station with remote scan and master volume	64.47
MSSDMC4RS*	4-wire retrofit room station with remote scan and master volume	43.20
MSSDMC4RW	4-wire retrofit patio station with remote scan and master volume	64.47

* Specify color: Blank - White, A - Almond, B - Black



MSSDMC3RS

Wall Housing Kits

MSSDMC1H	Wall Housing Kit includes: (1) Metal wall housing for DMC1 or DMC3-4 (1) FM Dipole Antenna, (1) Ferrite filter, (1) TE5D transformer assembly, 75 feet of MS4DCXSC shielded speaker cable, 25 feet of antenna wire, 1.5" snap-in bushings	52.58
MSSDMC1HC	Combination Wall Housing kit includes: (1) Metal wall housing for DMC1 or DMC3-4 with DMC1MM, (1) FM Dipole Antenna, (1) Ferrite filter, (1) TE2D Transformer Assembly, (1) TE5D Transformer Assembly, 75 feet of MS4DCXSC shielded speaker cable, 25 feet of antenna wire	83.26



MSSDMC1H

Wall Housing Kits with Rough-In-Rings

MSSDMC1HKIT	Wall Housing Kit with Rough-in Rings includes: (1) Metal wall housing for DMC1 or DMC3-4, (1) ME3 door speaker rough-in enclosure, (1) DMC1HRW Flush-mount Patio Rough-in Enclosure, (4) DMC1HR-5 Room Rough-in Rings, (1) FM Dipole Antenna, (1) Ferrite filter, (1) TE5D transformer assembly, 75 feet of MS4DCXSC shielded speaker cable, 25 feet of antenna wire	94.54
MSSDMC1HCKIT	Combination Wall Housing Kit with Rough-in Rings includes: (1) Metal wall housing for DMC1 or DMC3-4, (1) ME3 door speaker rough-in enclosure, (1) DMC1HRW Flush-mount Patio Rough-in Enclosure, (4) DMC1HR-5 Room Rough-in Rings, (1) FM Dipole Antenna, (1) Ferrite filter, (1) TE2D Transformer Assembly, (1) TE5D transformer assembly, 75 feet of MS4DCXSC shielded speaker cable, 25 feet of antenna wire	123.33



MSSDMC1HC



MSSDMC1HKIT



MSSDMC1HCKIT

Mounting Frames

MSSDMC1F*	Combination mounting frame is used in new and retrofit installations	25.67
MSSDMCFM*	Mounting frame used for replacement retrofit installations	32.55
MSSDMCFC*	Combination mounting frame used for replacement retrofit installations	48.84
MSSDMCFR	Room station retrofit mounting frame	19.41

* Specify color: Blank - White, A - Almond, B - Black



MSSDMC1F



MSSDMCFM



MSSDMCFC



MSSDMCFR

Call for details about 6-wire intercoms or video intercom solutions

DMC-10 Structured Wiring Intercom

MSSDMC10KIT	Structured wiring intercom kit includes hub, power supply, 1 door and 4 room stations, white	583.57
MSSDMC10H	Additional hub, adds 8 stations, includes power supply	380.83
MSSDMC10RS	DMC-10 room station, white	43.20
MSSDMC10DS	DMC-10 door station, white	36.31
MSSDMC10PS	DMC-10 patio station, white	60.73
MSSDMC10AWP	Audio input wallplate	43.20

Give us a call about room, door, and patio station color change kits



MSSDMC10KIT

Inlets + Brackets

LNVM149	Wall Inlet Valve Bracket	2.95
LNVM195*	Wall Inlet Valve *(A for Almond, B for Black)	3.52
LNVM241	Wall Inlet Valve Bracket (15-Pack)	2.00
LNVM3VK	3-Wall Inlet Valve Kit Includes: Quick Clips, 90-degree Sweep Fittings, 90-degree Single-sweep 3-way "T" Fittings, Pipe Straps with Wire Traps, 45-degree Short Elbow Fittings, Straight Coupling Fittings, 90-degree Short Elbow Fittings, Plastic Wall Inlet Valve Brackets, Wall Inlet Valves	47.64



LNVM3VK

High Voltage Inlets + Brackets

LNVM612	High-Voltage Wall Inlet Valve Rough-In Kit	13.78
LNVMVP	High-Voltage Wall Inlet	4.36
LNVMVP3K	3-Wall Inlet Valve Kit Includes: Quick Clips, 90-degree Sweep Fittings, 90-degree Single-sweep 3-way "T" Fittings, Pipe Straps with Wire Traps, 45-degree Short Elbow Fittings, Straight Coupling Fittings, 90-degree Short Elbow Fittings, High-Voltage Wall Inlet Rough-in Kits, High-Voltage Wall Inlet Valves	68.86



LNVMVP



LNVMVP3K

Automatic Dustpans

LNVMSP*	Automatic Dustpan *(A for Almond, B for Black)	35.83
LNVPAN*	Flush Mount Automatic Dustpan *(A for Almond, W for White)	28.85
LNVPANTP*	Automatic Dustpan Trim Plate *(W for White, A for Almond)	2.75



LNVPAN



LNVMSP

Fittings and Pipe

LNVM101-8	Pipe, 8', 8-pack	31.30
LNVM101L-10	Pipe, 10', 10-pack	52.58
LNVM101-280	Pipe, 8', 280-pack	1023.32
LNVM101L-200	Pipe, 10', 200-pack	973.97
LNVM102	Stop Coupling	0.19
LNVM103	90-Degree Sweep	0.40
LNVM104	90-Degree Short Elbow	0.37
LNVM105	90-Degree Double-Sweep 3-way T	0.90
LNVM106	90-Degree Single-Sweep 3-way T	0.56
LNVM112	45-Degree Short Elbow	0.33
LNVM113	45-Degree Short Spigot	0.40
LNVM114	45-Degree Y	1.05
LNVM115	90-Degree Sweep Spigot	0.69
LNVM119	Faceplate Extension	0.82
LNVM137	Pipe Cap	1.05
LNVM138	Pipe Collar	0.62
LNVM147	Pipe Strap with Wire Trap	0.33
LNVM207	30-Degree Short Elbow	0.77
LNVM450	Quick Clip	0.21
LNVM128	6-inch Steel Tubing	2.39
LNVM129	90-Degree Steel Street Elbow	12.76
LNVM130	90-Degree Steel Elbow	12.08
LNVM131	Straight Steel Coupling	3.76
LNVM132	45-Degree Steel Sweep Elbow	9.84
LNVM133	10-Foot Steel Tubing	25.43
LNVM139	Steel Pipe Sleeve	1.41

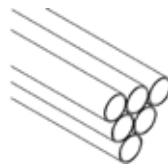

Pipe Section

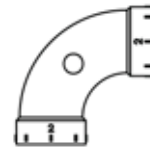

Sweep 90 Eil

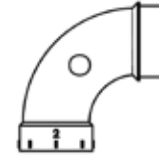

Sweep 90 Spigot

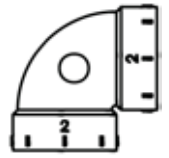

Short 90 Eil

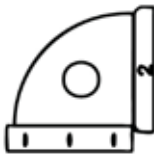

Small 90 Eil



45 Eil



45 Spigot



Stop Coupling

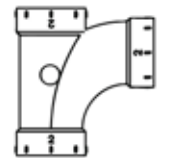

Sweep 90 Tee

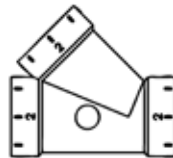

45 Wye

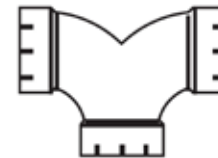

3 Way 90 Eil



Pipe Strap



Exhaust Cap



Pipe Collar

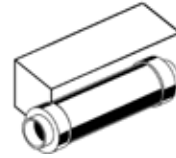

Exhaust Muffler



Pipe Glue

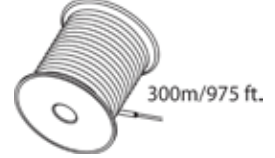

22/2 Wire

Platinum Series - Bag

LNAVP3000	Up to 3,000 square feet, 537 air watts peak, 120 volts	356.84
LNAVP7500	Up to 7,500 square feet, 551 air watts peak, 120 volts	421.94
LNAVP12000	Up to 12,000 square feet, 570 air watts peak, 120 volts	486.44
LNAVP24000	Up to 12,000 square feet, 627 air watts peak, 240 volts	486.44



Red Series - Bagless

LNAVR3000	Up to 3,000 square feet, 537 air watts peak, 120 volts	291.73
LNAVR7500	Up to 7,500 square feet, 551 air watts peak, 120 volts	324.29
LNAVR12000	Up to 12,000 square feet, 570 air watts peak, 120 volts	389.39
LNAVR24000	Up to 12,000 square feet, 627 air watts peak, 240 volts	437.85



Hoses and Accessories

LNV610PS	Deluxe SuperSystem Central Vacuum Hose	172.16
LNV510PS	Deluxe Central Vacuum Hose	165.27
LNV400S	Premium 30' Central Vacuum Hose	77.00
LNV222	Basic 30' Central Vacuum Hose	36.93
LNV361	"Slinky" Central Vacuum Hose	34.43
LNVM166	Metal Hose Rack	4.08
LNVM204	Fabric Central Vacuum Hose Cover	31.30
LNVM205	Deluxe Padded Fabric Central Vacuum Hose Cover, not for V510PS or V610PS	44.45
LNVM700	Deluxe Padded Fabric Central Vacuum Hose Cover	41.32



LNV610PS



LNV361

Tools, Wands, Brushes

LNVM251	Adjustable Carpet/Floor Tool	16.27
LNVM254	Dusting Brush	2.50
LNVM252	Floor/Wall Tool	8.77
LNVM256	Upholstery Tool with Brush	2.50
LNVM253	Crevice Tool	1.25
LNVM258	On-Board Tool Caddy	3.13
LNVMCD	Deluxe Canvas Tool Caddy	6.26
LNVMTC	Metal Telescopic Central Vacuum Wand with High-Voltage Cord	25.67
LNVMTE	Metal Telescopic Central Vacuum Wand	16.27



LNVM251



LNVM252



LNVM256



LNVMTC

Tool Kits

LNVM4200DS	Deluxe SuperSystem Accessory Package: Includes Deluxe Central Vacuum Hose, 14-inch Deluxe Power Brush with Headlight, Metal Telescopic Central Vacuum Wand with High-voltage Cord, Metal Telescopic Central Vacuum Wand, Metal Hose Rack, Crevice Tool, Upholstery Tool with Brush, Floor/Wall Tool, Dusting Brush, On-board Tool Caddy, Deluxe Canvas Tool Caddy.	314.27
LNVM2200DS	Standard Electric Accessory Package: Includes Deluxe Central Vacuum Hose, 14-inch Deluxe Power Brush with Headlight, Metal Telescopic Central Vacuum Wand with High-voltage Cord, Metal Telescopic Central Vacuum Wand, Metal Hose Rack, Crevice Tool, Upholstery Tool with Brush, Floor/Wall Tool, Dusting Brush, On-board Tool Caddy, Deluxe Canvas Tool Caddy.	292.99
LNVM1200S	Air-Driven Turbo System Accessory Package: Includes Central Vacuum Hose, 12-inch Air-Driven Turbo Brush, Metal Telescopic Central Vacuum Wand, Metal Hose Rack, Crevice Tool, Upholstery Tool with Brush, Floor/Wall Tool, Dusting Brush, On-board Tool Caddy, Deluxe Canvas Tool Caddy.	179.04
LNVMGAR	Deluxe Garage/Car Tool Kit: Includes Central Vacuum Hose, Plastic Telescopic Central Vacuum Wand, Crevice Tool, Upholstery Tool with Brush, Floor/Wall Tool, Dusting Brush, On-board Tool Caddy, Metal Hose Rack.	46.95
LNVMTKD	Deluxe Tool Kit: Includes Metal Telescopic Central Vacuum Wand, Adjustable Carpet/Floor Tool, Crevice Tool, Upholstery Tool with Brush, Floor/Wall Tool, Dusting Brush, On-board Tool Caddy, Metal Hose Rack, Deluxe Canvas Tool Caddy.	43.20



LNVM4200DS

LNVM1200S

LNVMGAR

Power Heads

LNVM458	14-inch Deluxe Power Brush with Headlight	173.17
LNVM179B	12-inch Air-Driven Turbo Brush	87.64



LNVM458



LNVM179B



LNVM178

VX Series Power Units

NUVX475	475W VX series power unit, bag	338.59
NUVX475C	475W VX series power unit, cyclonic	338.59
NUVX550	550W VX series power unit, bag	457.48
NUVX550C	550W VX series power unit, cyclonic	457.48
NUVX1000	1000W VX series power unit, bag	695.24
NUVX1000C	1000W VX series power unit, cyclonic	695.24

Powerfully clean. Brawn wasn't sacrificed for beauty. NuTone's motor designs deep clean far better than conventional vacuums. And with better filtration you won't spread the dust around either. Exhausted to the exterior of your home, the microscopic dust particles that simply scatter with conventional vacuums are ported outside. Your home is cleaner and indoor air quality is improved as well.

HEPA filtration. Microban protection. NuTone's new bags and filters feature HEPA-rated media and teflon anti-stick technology. Dust and bacteria are trapped better than ever before.

Accurate bag-full lights. Progressive indicator lights tell you at a glance when to change the bag. Features a true "bag-full" light and shuts down automatically to avoid rupturing the bag.

Simplified bag removal and filter changing. Just open the front-facing door panel and withdraw the full bag. NuTone's EasySnap bag change mechanism closes the opening immediately upon removal, so what goes in, stays in. Tap the clean side of the filter and any dirt stuck to it will fall into the debris bucket, not onto the floor.

Convenient installation. Left or right-hand intake ports simplify new or retrofit installations. The slim profile lets the tank fit in tight corners.



NUVX475



NUCV400 Compact Power Unit, 11" x 30"H 275.62

A perfect fit for any apartment, condominium or home up to 2,200 square feet. This compact unit is small enough to fit in a mud room, laundry room or even a closet. The compact power unit operates quietly when mounted near your living area and is virtually sound-free when mounted in a basement or garage.

Tool Kits and Garage Kits

NUCK355	Deluxe Electric Kit, CK230 plus: power nozzle, CH615 electrified hose, hose sock, cord, wand	420.58
NUCK350	Deluxe Electric Kit, CK230 plus: power nozzle, CH515 electrified hose, hose sock, cord, wand	420.58
NUCK250	Air Turbine Kit, CK120 plus: turbine brush, hose, hose sock	222.62
NUCK150	Standard Tool Kit, CK120 plus: low-voltage hose, hose sock	180.19
NUCK140	Deluxe Garage & Car Care Kit, 30 ft. orange crush-proof hose, hanger and tools	60.88



NUCK350



NUCK250



NUCK150

Design Assistance

Worthington Distribution is proud to offer our Dealers/Installers assistance in designing Central Vacuum systems. Whether the system is large or small our expert technical staff can help. If you have questions or need help with design assistance, give Worthington Distribution a call today!

Worthington Distribution carries the full Nutone Line.

Hoses, Cords, Tools and Accessories

NUCA130	Washable sock hose for 30'-32' hoses	24.79
NUCH230	Standard 30' crushproof hose	76.99
NUCH515	Deluxe 30' current carrying hose w/ comfort grip, Frost White	203.86
NUCH615	Direct connect 30' current carrying crushproof hose w/ ergonomic swivel handle, Frost White	203.86
NUCK120	Standard tool set, includes floor/rug tool, wands, upholstery brush, dusting brush, tool caddy	62.46
NUCK135	Ratcheting wand, extendable 22"-39"	28.24
NUCK145	50' Ultra Deluxe Garage Kit. Includes: orange hose, upholstery tool, crevice tool and more	100.51
NUCK230	Deluxe tool set, includes floor/rug tool, ratcheting wand, crevice tool, upholstery tool, dusting brush, tool caddy	73.57
NUCT156B	Natural Bristle Hardwood Floor Tool	21.88
NUCT157B	Extra Wide Natural Bristle Hardwood Floor Tool	26.47
NUCT102G	Round dusting brush w/ nylon bristles, Gray	3.85
NUCT700	Deluxe power brush, see below for wands	168.23
Use CT170 for CH520/CH620, use CT175 for CH515/CH615		
NUCT170	Wand for CH520/CH620 hoses for CT700	28.80
NUCT175	Wand for CH515/CH615 hoses for CT700	28.80
NU376UL	UL Listed 18/2 wire, 100'	14.73
NU391	Pack of 3 bags, 6 gallon capacity, for use with all Advantage and Classique power units	6.86
NUVX3916	Pack of 3 bags, 6 gallon capacity, for use with VX475 series power units	10.52
NUVX3918	Pack of 3 bags, 8 gallon capacity, for use with VX550/VX1000 series power units	45.13
NUVX3918STD	Same as above but with HEPA filtration	11.50



NUCH230



NUCH156B



NUCT600

Inlets

NU330NIV	Automatic on/off non-electrified inlets that match the style of the ElectraValve electrified inlets. Ivory.	6.01
NU330W	Automatic on/off non-electrified inlets that match the style of the ElectraValve electrified inlets. White.	6.01
NU360AL	Horizontal automatic on/off non-electrified inlets that match the style of the ElectraValve electrified inlets. Almond.	11.99
NU360BG	Horizontal automatic on/off non-electrified inlets that match the style of the ElectraValve electrified inlets. Beige.	11.99
NU360*	Horizontal automatic on/off non-electrified inlets that match the style of the ElectraValve electrified inlets. *IV-Ivory, W-White.	11.99



Twist & Mount

Twist & Mount patch panels allow installers to punch-down Cat 5e or Cat 6 cabling on component-rated commercial patch panels. The low profile of the Twist & Mount provides extra room for patch cord bend radii in the Structured Media Center.



Pages 164-168



In-Wall MP3 Player System

Enjoy stereo-quality sound from an MP3 player with this sleek amplified in-wall keypad. Includes everything needed to install a system. Just add speaker(s) and MP3 player. Easy one-room solution installs in less than an hour.



Pages 169-175



Designer Enclosure Covers

Designed for Channel Vision's enclosures, the designer covers provide more space inside the enclosure and they enable increased airflow with the use of top and bottom vent holes or an optional fan kit (model C-1322).



Pages 176-177



Nose Plates

Cut a hole in the wall and install the low-voltage mounting plate bracket. Then simply pull your cables through the mounted low-voltage mounting plate bracket and then through the recessed low-voltage cable plate.



Page 178



Wallplates

Wallplates complete your structured wiring installation and hold all the jacks in place for your wire termination. Generally 1-6 ports are available per plate.



Jacks

Jacks come in a variety of formats to allow for all types of wiring including phone, data, "F", RCA, BNC and many more.



Data Termination

Data runs are generally terminated to a patch panel or a phone/data termination module. Once the data runs are terminated, you can then connect them to your router or switch. Cat 5e can give you all the way up to Gigabit connectivity and is most often used. Cat 6 is becoming more popular now for "high" bandwidth applications such as video streaming and requires special terminations.



Telephone

Telephone runs are terminated to a patch panel or phone/data termination module. Once the phone runs are terminated, you then can connect them to your phone distribution block or to your phone system. Cat 5e has become the standard wiring to use for phone runs. You can use either 6-conductor or Cat 5e jacks to terminate on the room side.

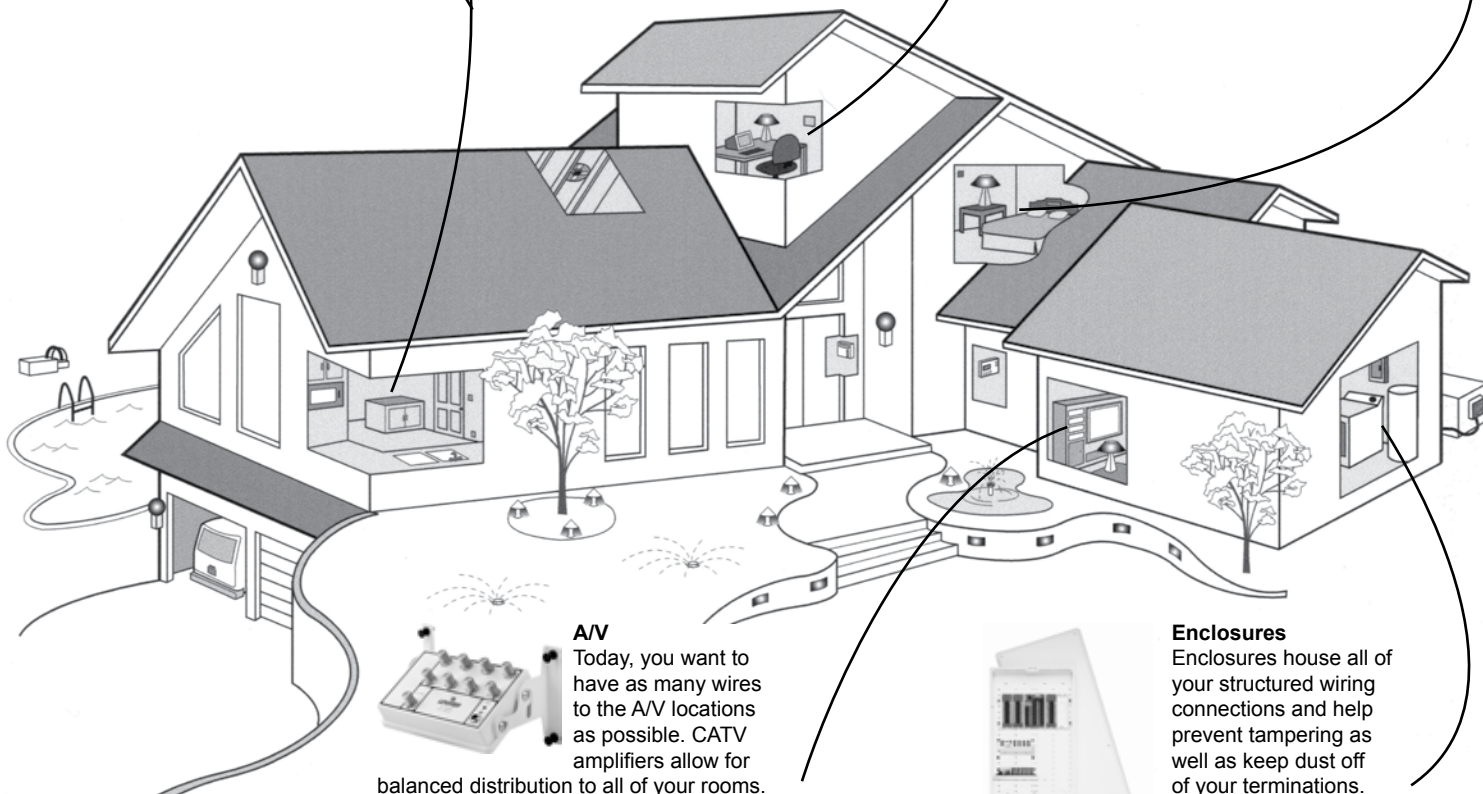

AV

Today, you want to have as many wires to the A/V locations as possible. CATV amplifiers allow for balanced distribution to all of your rooms. You will usually also have two or more Cat 5e runs that need to be terminated for network, IR or for future-proofing your installation. Most manufacturers have jacks and plates for IR, HDMI, VGA and any type of connection that you may require.



Enclosures

Enclosures house all of your structured wiring connections and help prevent tampering as well as keep dust off of your terminations. Many sizes are available and you can usually purchase mounts for security panels and more to keep all of your hardware in one place.

Series 420 Enclosures



The 420 Series enclosure has capacity for up to 12 modules depending on selection and density and can also simultaneously accommodate many diverse wiring requirements.

LEV47605-42W	42" Enclosure with flush door	93.71
LEV47605-42N	42" Enclosure only	62.67
LEV47605-F42	42" Flush mount door	36.56
LEV47605-42D	42" Hinged door	49.97
LEV47605-42P	42" Premium hinged door	58.75

LEV47605-42W

Series 280 Enclosures

The 280 Series enclosure can comfortably accommodate up to 8 distribution modules depending on selection and density.



LEV47605-28N

LEV47605-28W	28" Enclosure with flush door	62.67
LEV47605-28N	28" Enclosure only	43.09
LEV47605-F28	28" Flush mount door	20.90
LEV47605-28D	28" Hinged door	37.02
LEV47605-28P	28" Premium hinged door	45.70

Series 140 Enclosures

The 140 Series is the entry level for beginning home networking. This enclosure creates one distribution point for an apartment or smaller home for low voltage cables.



LEV47605-14E

LEV47605-140	14" Enclosure with flush door	30.04
LEV47605-14E	14" Enclosure only	22.72
LEV47605-14C	14" Flush mount door	15.67
LEV47605-14D	14" Hinged door	27.42
LEV47605-14P	14" Premium hinged door	32.65

Media Versatile Panel

The Media Versatile Panel was made for custom retrofits and remodeling. The panel with its 3/8" plywood backing has an open architecture, allowing simple, flexible mounting of all components.



LEV47602-24E

LEV47602-24E	Panel with cover	63.65
LEV47602-BKE	Stud brackets	12.99

Multi-Dwelling Units



LEV47604-F6S

This unit offers a compact, cost-effective distribution point for media in smaller apartments and small condominiums. Easy to install, the MDU accommodates a variety of telephone and video configurations.

LEV47605-MDU	MDU enclosure only	19.58
LEV47605-MDC	MDU cover only	12.93
LEV47604-F6	MDU w/ 1x6 phone module	31.62
LEV47604-F6S	MDU w/ 1x6 phone and 6-way video modules	43.60

See pages 164-168 for additional Leviton structured wiring products

Enclosure Accessories

LEV47612-28B



Extender Brackets
 • Adds 2 Inch Depth • Adds Wire Management
 • Adds Ventilation • Allows Larger Modules



LEV5L000-L0K

LEV5L000-L0K	Lock kit for hinged door	8.34
LEV47612-28B	Extender bracket for 280	37.35
LEV47612-42B	Extender bracket for 420	40.72

Enclosure Brackets



LEV47612-SBK



LEV47612-EBK



LEV47612-HBK



LEV47612-DBK



LEV47612-FSB



LEV47612-UBK

LEV47612-SBK	Single module mounting bracket	15.67
LEV47612-EBK	Full size expansion bracket	25.50
LEV47612-HBK	Half size 3 module mounting bracket	19.52
LEV47612-DBK	Data bracket for modem/router/switch	19.52
LEV47612-6SB	6" Universal security bracket	19.52
LEV47612-1SB	12" Universal security bracket	32.54
LEV47612-UBK	Universal battery bracket	26.03
LEV47612-HSB	Half width 6" universal security plate	16.91
LEV47612-FSB	Full width 12" universal security plate	22.12
LEV47612-CBK	Combo bracket, install Leviton modules in most structured wiring enclosures	19.58

Enclosure Power Supplies



LEV48212-6S



LEV47605-DP/NDP



LEV47605-PSA

LEV48212-6S	Surge protected, 6-outlet	78.10
LEV47605-DP	Surge protected, 4-outlet	60.56
LEV47605-NDP	Non-surge protected, 4-outlet	32.21
LEV47605-ACS	Surge protected, 2-outlet	22.46
LEV47605-ACN	Non-surge protected, 2-outlet	9.77
LEV47605-PSA	12VDC 9 plug + 1 IEC AC receptacle	137.94
LEV47605-PSB	Mini 12VDC 3 plug	66.57
LEV47605-PSC	12VDC 6 plug + 2 AC receptacle	132.76

Full Width Telephone/Data/Cable Combo Modules

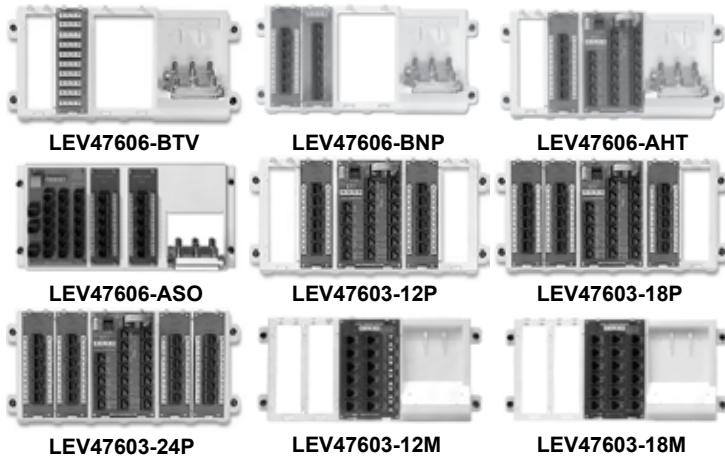

LEV47606-BTV	4x9 phone and 1x6 video	51.26
LEV47606-BNP	4x6 phone and 1x6 2ghz video	75.49
LEV47606-AHT	Phone board, 6-port patch, and 1x6 video	94.34
LEV47606-ASO	Phone board, 12-port patch, and 1x6 video	116.41
LEV47603-12P	12-port mixed phone line distribution	119.62
LEV47603-18P	18-port mixed phone line distribution	142.14
LEV47603-24P	24-port mixed phone line distribution	163.93
LEV47603-12M	12-port 4 phone line distribution	40.60
LEV47603-18M	18-port 4 phone line distribution	58.97
LEV47603-8C1	Same as above with 6-port patch	76.14

Half Width Telephone/Data/Cable Combo Modules

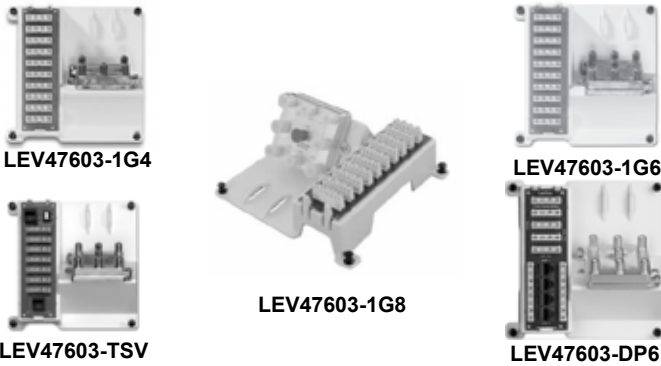

LEV47603-1G4	4x9 phone and 1x4 video	32.54
LEV47603-1G6	4x9 phone and 1x6 video	41.65
LEV47603-1G8	4x9 phone and 1x8 video	45.55
LEV47603-TSV	4x6 phone with RJ31x and 1x8 video	52.07
LEV47603-DP6	4x4 phone, 4-port data, and 1x6 video	49.47

Single Voice/Data Modules on a Bracket

LEV47605-C5B	6-port Cat 5e patch board	22.43
LEV47609-TSV	4x6 phone with RJ31X jack	37.03
LEV47616-DSB	DSL filter board	34.38
LEV47689-B	4x9 bridged 110 board	21.75

We carry Leviton Fiber solutions, call for pricing!

Network Modules



LEV47611-GT4	4-port 10/100 ethernet router	60.39
LEV47611-5PT	5-port 10/100 ethernet switch	36.07
LEV47611-8PT	8-port 10/100 ethernet switch	51.11
LEV47611-5GB	5-port 10/100/1000 ethernet switch	80.11

Stand-Alone Telephone/Data Modules

LEV476TM-524	Cat 5e twist & mount RJ45 panel	117.46
LEV476TM-624	Cat 6 twist & mount RJ45 panel	162.49
LEV47603-110	4x9 bridged 110 board	22.42
LEV47609-F6	4x6 bridged 110 board w/ RJ45 expansion	17.46
LEV47609-S10	6x10 bridged 110 board w/ RJ31x	29.09
LEV47609-D5P	4x5 phone w/ data pass-through	13.04
LEV47609-4DP	4x4 phone and 4-port Cat 5e patch	21.13
LEV47609-4	4x4 bridged 110 board	13.04
LEV47603-C5	6-port Cat 5e patch board	20.81
LEV47611-C6	6-port Cat 6 patch board	39.71
LEV47609-EMP	4x7 bridged 110 to RJ45 board	24.66
LEV47609-TSV	6x4 bridged 110 board	37.03
LEV47616-DSF	DSL filter board	22.42
LEV47603-TDM	24-port mixed phone line distribution	59.76
LEV47603-12B	4x12 bridged 110 to RJ45 board	28.98
LEV47603-18B	4x18 bridged 110 to RJ45 board	45.95

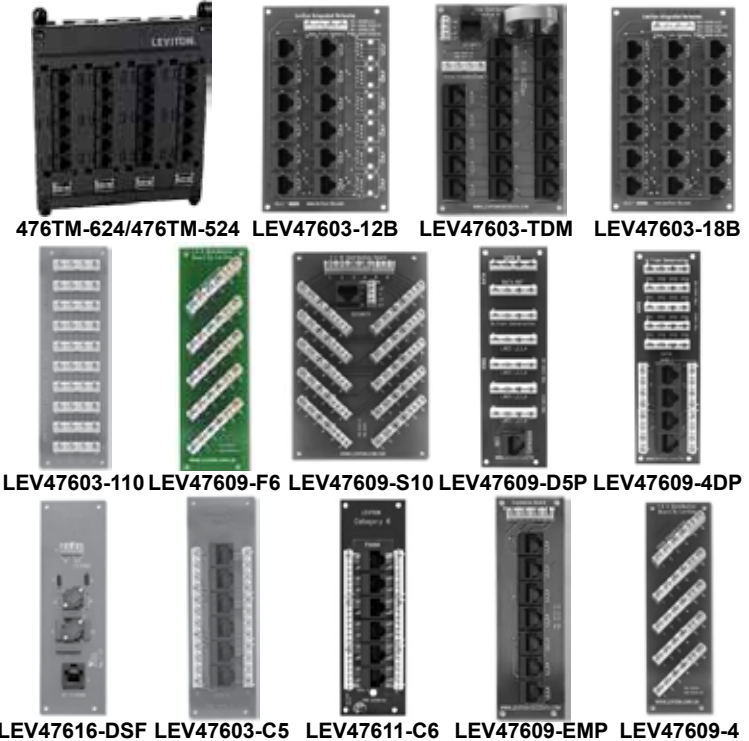

476TM-624/476TM-524 LEV47603-12B LEV47603-TDM LEV47603-18B
 LEV47603-110 LEV47609-F6 LEV47609-S10 LEV47609-D5P LEV47609-4DP
 LEV47616-DSF LEV47603-C5 LEV47611-C6 LEV47609-EMP LEV47609-4

Quickport Wallplates and Wallplate Inserts

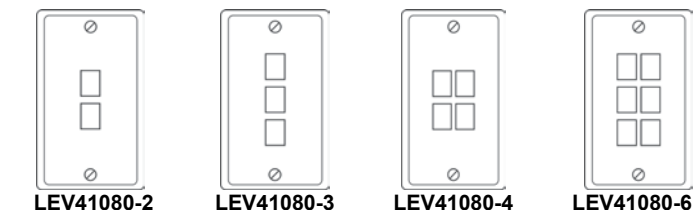
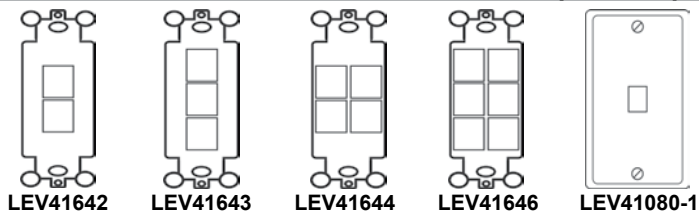

LEV41080-6*P	6-port flush-mount	1.25
LEV41080-4*P	4-port flush-mount	1.25
LEV41080-3*P	3-port flush-mount	1.25
LEV41080-2*P	2-port flush-mount	1.25
LEV41080-1*P	1-port flush-mount	1.25
LEV40807-B*	4-port wallplate-2 angled	3.70
LEV40807-B2*	8-port wallplate-4 angled	6.47
LEV41646-*	6-port decora insert	3.05
LEV41644-*	4-port decora insert	3.05
LEV41643-*	3-port decora insert	3.05
LEV41642-*	2-port decora insert	3.05

* Available in - WH-White, IV-Ivory,
(Additional Colors Available, Call for Stock)

Premium Amplified Video Distribution Modules



LEV47693-8P



LEV47693-16P

LEV47693-1P	1x1 15db gain, gold connector	110.64
LEV47693-8P	1x8 4db gain, gold connector	143.17
LEV47693-16P	1x16 0db loss, gold connector	221.27
LEV47693-31P	3x1 passive combiner, not powered	14.00

Amplified Video Distribution Modules



LEV48210-VA

LEV48210-VA	1x1 10-25db adjustable gain	23.46
-------------	-----------------------------	-------

Amplified Satellite Multi-Switch Modules

LEV47691-3MS	3x4 multi-switch, nickel connector, for use with DirecTV systems only. Use LEV48210-VA listed above for increased signal strength.	50.92
--------------	--	-------



**Dont forget F-Conn Series
Compression Connectors!
See Page 179**



	LEV5G108-R*5	8-conductor Cat 5e jack	3.36
	LEV61110-R*6	8-conductor Cat 6 jack	6.54
	LEV5G108-24*	Cat 5e 24 pc. GreenPack	76.60
	LEV61110-24*	Cat 6 24 pc. GreenPack	149.27
	LEV5EHOM-R*5	HOME 5e Connector, Standard	2.25
	LEV5ETLS-R*5	HOME 5e Connector, Tool-Free	3.25
	LEV61HOM-R*6	HOME 6 Connector, Standard	4.46
	LEV61TLS-R*6	HOME 6 Connector, Tool-Free	5.20
	LEV41106-R*6	8-conductor USOC jack	2.07
	LEV41108-R*5	8-conductor Cat 5 jack	3.23
	LEV41106-R*6	6-conductor jack	2.07
	LEV40731-B*	Nickel-"F"-type, female-female	1.42
	LEV40831-B*	Gold-"F"-type, female-female	2.36
	LEV40830-B*Y	RCA jack w/ yellow stripe	2.44
	LEV40830-B*E	RCA jack w/ black stripe	2.44
	LEV40830-B*R	RCA jack w/ red stripe	2.44
	LEV41084-B*F	BNC jack, female-female-Nickel	3.96
	LEV40832-B*	BNC jack, female-female-Gold	4.40
	LEV40837-B*E	Banana jack w/ black stripe	2.34
	LEV40837-B*R	Banana jack w/ red stripe	2.34
	LEV40833-B*E	Binding post w/ black stripe	2.71
	LEV40833-B*R	Binding post w/ red stripe	2.71
	LEV40734-SV*	S-video connector, 110 punch	6.24
	LEV40734-CV*	S-video to S-video connector	14.29
	LEV40735-RR*	RCA 110-type right audio-Red	4.76
	LEV40735-RW*	RCA 110-type left audio-White	4.76
	LEV40735-RO*	RCA 110-type dig.audio-Orange	4.76
	LEV40735-RY*	RCA 110-type video-Yellow	4.76
	LEV40735-RV*	RCA 110-type video-Green	4.76
	LEV40735-RL*	RCA 110-type video-Blue	4.76
	LEV40839-S*S	3.5mm to screw Terminal	5.85
	LEV41084-B*B	QuickPort blank, bag of 10, priced each	0.15

* - Available in W-White and I-Ivory-
(Additional Colors Available, Call for Stock)

Passive Video Distribution Modules

LEV47690-4	1x4 1ghz, CATV splitter	5.93
LEV47690-G4	1x4 2ghz, CATV splitter	8.89
LEV47690-4C	1x4 1ghz, CATV splitter for SMC	17.14
LEV47690-4C2	1x4 2ghz, CATV splitter for SMC	13.98
LEV47690-6	1x6 1ghz, CATV splitter	9.88
LEV47690-G6	1x6 2ghz, CATV splitter	12.85
LEV47690-6C	1x6 1ghz, CATV splitter for SMC	21.08
LEV47690-6C2	1x6 2ghz, CATV splitter for SMC	20.41
LEV47690-8	1x8 1ghz, CATV splitter	13.83
LEV47690-G8	1x8 2ghz, CATV splitter	16.80
LEV47690-8C	1x8 1ghz, CATV splitter for SMC	25.03
LEV47690-8C2	1x8 2ghz, CATV splitter for SMC	29.21

Cameras/Camera Modules

Cat 5 Camera System Basic Wiring Diagram

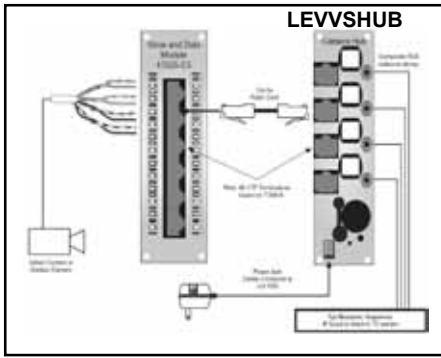

LEVSSHUB	4-port camera hub with RJ45	130.16
LEVSSHUB-ICD	4-port camera hub with 110 punch	130.16
LEVVSIND-SC	Decora indoor Cat 5 Camera	126.12
LEVVSOUT-W	Outdoor Cat 5 IR camera, 30' IR distribution	166.63
LEV48213-CVS	4 Input video sequencer 1-30 second	195.24
LEV47690-NFA	RF Notch Filter	21.25

Wiring Accessories

LEV5G460-5L	Cat 5e Patch Cord 5' Blue	2.39
LEV5G460-15L	Cat 5e Patch Cord 15' Blue	4.06
WAV5E04URBL1	Cat 5e PVC CMR rated 1000' Blue	69.94
PT100004	EZ RJ-45 Heavy Duty Crimp Tool	46.46
PT202035J	EZ RJ-45 Cat 5/5e connectors 100 piece jar	0.18
PT15015	Cat 5 cable jacket stripper	8.96

Electric Vehicle Charger Application Note

Leviton offers a complete solution for residential, commercial and public plug-in electric vehicle charging: the Evr-Green™ line of electric vehicle supply equipment. Whether you are an EV driver, a commercial business, utility company or municipality, there's an Evr-Green solution for you. See Leviton's website (www.leviton.com) for more information regarding Federal incentives for commercial and residential applications.

See Page 35 for More Details

Surge Suppressor Application Note

Leviton's surge protection devices are designed to reduce the random energy surges of voltage transients and electrical noise on the power supply line. Leviton offers comprehensive lines of devices that range from Type 1 Surge Arrestors, the first line of defense against external surges, to Type 2 Surge Panels and Type 3 Point-of-Use devices, such as strips and receptacles. Leviton also offers Type 4 UL recognized surge protection components used for wired-in protection of industrial factory automation equipment.

See Page 37 for More Details

NEC Phone Application Note

NEC phone systems offer a great solution to get involved in the residential and commercial communication markets. Have a customer looking to turn off the lights or change the room temperature from their bed? Integrate NEC phones with an HAI automation system for outstanding seamless integration and whole house control.

See Page 153 for More Details

DVR Application Note

A perfect way to upgrade an existing analog camera system or to accomplish fantastic results for a new installation is with an EverFocus DVR. Simply enable the mobile-viewing feature of the DVR and have access to each camera anywhere in the world with EverFocus's free DDNS server. This also provides a great way to bring up cameras on an HAI touchscreen.

See Page 112 for More Details

Leviton Audio Distribution Modules/Plates

LEVSGAMP	6-room impedance matching module for use with SGVST volume control	149.82
LEV48211-6A	1x6 passive audio module for use with SGVSM-W volume control	38.31
LEVAEMRK	Multi-room speaker connection plate	24.76



Leviton Decora Volume Controls

LEVSGVST-W	Strauss slider; use with SGAMP distribution module	44.23
LEVSGVSM-W	Strauss impedance matching slider; use with AE6MA amp	52.07
LEVSGVCK-*	Color change kit for SGVST/SGVSM	5.73



*- IV-Ivory, E-Black, LA-Light Almond

LEVSGVST-W/
LEVSGVSM-W

Leviton Spec-Grade Speakers

When the installation calls for sound, Leviton's SpecGrade speakers are a true value solution for the audio/video entertainment revolution. Engineered to deliver the maximum audio performance possible for their price range, SpecGrade Sound speakers achieve their design objective through advanced audio technologies such as AeroNylon dome tweeters, Kevlar-treated woofers, and AutoSurge™ protection circuitry.

LEVSGC65-W	6.5" In-ceiling 120W Kevlar woofer-pair	58.70
LEVSGI65-W	6.5" In-wall 120W Kevlar woofer-pair	69.78
LEVSGI80-W	8" In-wall 160W Kevlar woofer-pair	107.23
LEVSGO99-W	5.25" Two-Way Outdoor/Utility-each	98.57



Leviton Speaker Rough-In Brackets

LEVPCI65-KIT	6.5" In-wall-pair	19.55
LEVPCI80-KIT	8" In-wall-pair	24.76
LEVPC55-KIT	6.5" In-ceiling-pair	17.39



Installation Tools and Accessories

PT100004	EZ-RJ45 crimp tool	46.46
PT100003C	50-pack of EZ-RJ45 connectors	0.47
PT202003J	100-piece jar of EZ-RJ45 connectors	46.46
ICMCPLCCT-SLM	Coax master compression tool	88.77
ICMFSNS6U	RG6 compression "F" connector	0.44
ICMFS6RCAU	Universal RCA connector	1.22
LEV43115-15	15' x 1/2" velcro strap	11.48
LEV43115-75	75' x 1/2" velcro strap	42.28



PT100004



ICMFS6U



ICMFS6RCAU



ICMCPLCCT-SLM



EZ-RJ45 Connectors

Rack-Mount Patch Panels

Solution for cable and wire management in commercial applications.



LEV49255-H24



LEV49251-W62



LEV5G596-U24

LEV49255-H24	24-port w/ wire management without inserts	52.18
LEV49255-H48	48-port w/ wire management without inserts	71.17
LEV5G596-U12	GigaMax 12-port Cat 5e patch panel	81.77
LEV5G596-U24	GigaMax 24-port Cat 5e patch panel	109.56
LEV5G596-U48	GigaMax 48-port Cat 5e patch panel	219.09
LEV69586-U12	eXtreme 6+ 12-port Cat 6 patch panel	113.42
LEV69586-U24	eXtreme 6+ 24-port Cat 6 patch panel	173.66
LEV69586-U48	eXtreme 6+ 48-port Cat 6 patch panel	342.10
LEV49251-W62	2-space hinged wall-mount bracket	43.07
LEV49251-W63	3-space hinged wall-mount bracket	52.86

Call for pricing on both Cat 5e and Cat 6 96-port panels

Category Rated UTP Patch Cables (*-W-White, Y-Yellow, R-Red, B-Blue, S-Grey, E-Black, G-Green)



Cat 5e	
LEV5G460-3*	Cat 5e patch cord, 3' 2.09
LEV5G460-5*	Cat 5e patch cord, 5' 2.39
LEV5G460-7*	Cat 5e patch cord, 7' 2.67
LEV5G460-15*	Cat 5e patch cord, 15' 4.06

Recessed Line/Low Voltage Boxes

Recommended choice for tight applications behind any flat panel TV!
The LEV690 is excellent for new installs of LCD, Plasma, and LED TV's.



LEV690



LEV47617-REB



LEV689



LEV47617-RBH

LEV689-*	1-gang recessed plate/box with duplex receptacle, 15A rated	9.47
LEV690-*	2-gang recessed plate/box with duplex receptacle, 15A rated, and 6 quickport low voltage inputs	10.98
LEV47617-REB	Entertainment box with 3 single-gang box openings for line or low voltage retrofit rings	23.43
LEV47617-RBH	Same as above with high profile cover	20.56

*- E-Black, I-Ivory, W-White, T-Light Almond

Home Theater Wallplates

LEVAEHTK	Interface wallplate, 14 gold-plated spring clips, two RCA, two QuickPorts	70.37
LEVAEMRK	Multi-Room wallplate, two spring clips, two Quickports	24.76

Recessed Entertainment Box Accessories

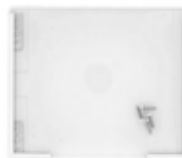

LEV47617-HPC



LEV47617-LPF



LEV47617-PLT

LEV47617-HPC	Entertainment box high profile cover	14.53
LEV47617-LPF	Entertainment box low profile cover	6.57
LEV47617-PLT	Entertainment box blank snap-in plate	2.75
LEV47617-REB	Recessed entertainment box includes LPF	23.43
LEV47617-RBH	Recessed entertainment box includes HPC	20.56

42" Enclosures



42" enclosure features universal On-Q style mounting holes. It also includes larger top openings that make pulling wire easier and side tabs.

ONQEN4280	42" enclosure only	71.19
ONQEN4260	42" hinged door	62.39
ONQEN4220	42" screw-on door	43.22
ONQEN4250	42" with hinged cover	124.90
ONQEN4200	42" with screw-on cover	93.68

28" Enclosures

ONQEN2880	28" enclosure only	32.66
ONQEN2860	28" hinged door	49.34
ONQEN2820	28" screw-on door	24.86
ONQEN2850	28" with hinged cover	81.81
ONQEN2800	28" with screw-on cover	62.45



ONQEN2850

20" Enclosures

ONQEN2080	20" enclosure only	28.73
ONQEN2060	20" hinged door	38.46
ONQEN2020	20" screw-on door	20.87
ONQEN2050	20" with hinged cover	64.56
ONQEN2000	20" with screw-on cover	46.11



ONQEN2050

14" & 12" Enclosures

ONQEN1480	14" enclosure only	22.67
ONQEN1460	14" hinged door	33.75
ONQEN1420	14" screw-on door	17.36
ONQEN1450	14" with hinged cover	56.57
ONQEN1400	14" with screw-on cover	29.98
ONQEN1200	12" with screw-on cover	27.35



ONQEN1480

Enclosure Accessories

ONQ364450-03	28" enclosure extender	35.03
ONQ364450-04	42" enclosure extender	45.04
ONQ364478-01	Replacement lock assembly - hinged door	7.87
ONQ364482-01	Wire manager, enclosure extender	18.02
ONQ364570-01	Custom wire management module	6.36
ONQF2249	2.5" knock-out plugs	4.22
ONQF2242	2.5" grommet ring	1.09
ONQ363491-01	Velcro tie straps (50-pc package)	27.55
ONQ363729-01	Grommet/plunger replacement kit	9.26
ONQF2250	Additional pins & rivets (pkg of 50)	38.28
ONQAC1031	Power strip module - full width	31.00
ONQ364569-02	Surge protected duplex outlet kit	47.11



ONQ364450-03/04



ONQ364266-01

ONQ364570-01

Tools and Accessories

ONQ364347-01	Extended coax connector wrench	4.27
ONQ362721-02	RG6 coax stripper	22.22
ONQ363292-01	Cat 5e strip and fit tool	18.27
ONQ363293-01	110 punch down tool, impact	61.10
ONQ364555-01	EZ-RJ45 modular plug hand tool	62.38
ONQAC3400	Punch & Go Tool	24.52



ONQAC3400

ONQ364555-01

ONQ363292-01

ONQ364347-01

ONQ363291-01

ONQ362721-02

ONQ363293-01

Coax and Category Cable Connectors

ONQ363140-03	"F" plug - RG6 quad shield, hex crimp	0.32
ONQ364246-01	"F" plug - 360 conical coax	0.37
ONQ364554-01	EZ-RJ45 modular plug	0.56
ONQ364405-01	High performance RJ45 modular plugs	0.41



ONQ364246-01/
ONQ364246-02

ONQ363140-03

ONQ364554-01/
ONQ364405-01

Power Supply Specification Chart

Model #	Description	VDC	Amp	Use this supply
ONQAU7396	Cat5e Audio Module	24V	2.5 Amp	ONQPW1060
ONQAU1002	MS/MZ Cat 5e audio	24V	2.5 Amp	ONQPW1060
ONQIC1000	Intercom module	24V	2.5 Amp	ONQPW7725
ONQVM7640	1x1 video amplifier	15V	150 mA	ONQPW7760
ONQF7630	3x4 video amp	15V	150 mA	ONQPW7725
ONQHA6001	Integration Module	24V	2.5 Amp	ONQPW1060
ONQIC5001	Selective Call hub	24V	1.5 Amp	ONQPW1030

Power Management for Enclosures

ONQPW1060	24 volt, 60 watt wall-mount	91.89
ONQF7715	15 volt, 1.45 amp desk-mount	33.45
ONQPW7760	15 volt, 1000 milliamp wall-mount	13.84
ONQPW7725	12 volt, 2.5 amp power supply	48.44
ONQPW7639	Multi-voltage (requires 15v supply)	68.00
ONQF7526	AC power kit - duplex receptacle In J-box	8.58



ONQPW1060

ONQF7715

ONQF7760

ONQF7725

ONQPW7639

Telephone Distribution Modules

ONQ1267058-01	6-port expansion module	37.86
ONQ1267062-01	4x6 basic module	38.61
ONQ363484-02	4x12 basic module	71.28
ONQ363485-01	4x11 KSU/PBX	94.34
ONQ364551-01	4x8 enhanced	55.36
ONQ364559-01	8-port enhanced expansion module	47.05
ONQTM1478	4x12 with config. primary line + surge	44.10
ONQTM1478	4x12 telecom module with RJ-31x	44.10
ONQTM7554	4x10 punchdown module	33.69
ONQTM7554	4x10 punchdown module with RJ-31x	33.69
ONQTM7556	4x8 module with RJ-31x	27.45
ONQTM7560	4x24 module with RJ-31x + surge	83.06



ONQ1267058-01 ONQ1267062-01 ONQ364559-01 ONQ364551-01
 ONQ363484-02 ONQ363485-01 ONQTM1478 ONQTM7553
 ONQTM1475 ONQTM7554 ONQTM7556 ONQTM7560

Phone/Data/Coax Surge Protection Units

ONQ363487-01	Telecom surge suppression unit	27.05
ONQ364599-01	Telecom service conditioning module	14.81
ONQ364602-01	Security interface conditioning unit	24.94



ONQ363487-01 ONQ364600-01 ONQ364598-01
 ONQ364599-01 ONQ364602-01

Telephone and Data Distribution Combo Module

Distributes phone and data to up to six rooms with the convenience of a single pull of Cat 5 cable.



ONQCO1000

Features:

- Provides two phone lines and one data connection to up to six rooms
- Perfect retrofit product where one Cat 5 cable was installed
- 100 Mbps Ethernet to existing Cat 5-based phone structure

ONQCO1000	6-port phone/data module	55.44
-----------	--------------------------	-------

Passive Cable Distribution Modules

ONQVM1000	1x4 splitter/combiner, DC passing	14.99
ONQVM1002	1x8 splitter/combiner, DC passing	Best Seller! 28.55



ONQVM1000



ONQVM1002

Enhanced Video Modules

ONQ363469-02	3x8 enhanced video module	202.96
ONQ364219-01	Video engine	124.73
ONQ364522-01	2x16 enhanced video module	251.36
ONQVM7632	2x2 bi-directional video module	121.62
ONQVM7640	1x1 bi-directional video module	37.72



ONQ363469-02



ONQ364522-01



ONQVM7632



ONQVM7640

Video Distribution Accessories

ONQ364596-01	12-port video interface module	51.60
ONQ363915-01	8-port video interface module	34.06
ONQ364680-01	RF coax surge protector	23.36
ONQ364456-03	Low pass filter, 5-750mhz	24.07
ONQ364412-01	Terminators, 75 ohm	0.61



ONQ364596-01

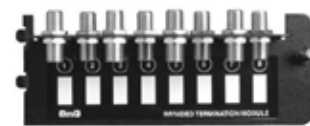

ONQ363915-01



ONQ364456-02/03



ONQ364412-01



ONQ364680-01

Telephone/Video Combo Modules

ONQ364400-04	6x4 basic module	30.63
ONQ364400-10	11x8 basic module	60.73
ONQ364400-13	8x8 module, security	59.59
ONQEN1022	6x4 basic kit with enclosure	70.11



ONQ364400-04

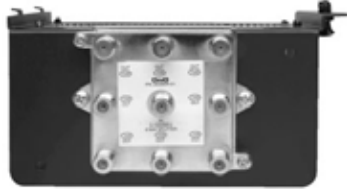

ONQ364400-13

Network Patching Modules



ONQ363486-01

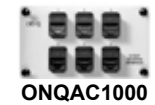

ONQAC1000

ONQ363486-01	8-port Cat 5e interface	57.58
ONQAC1000	6-port Cat 5e plate	30.06
ONQAC1012	6-port Cat 5e interface	35.27
ONQAC1014	12-port Cat 5e interface	53.62
ONQAC1015	12-port Cat 6 interface	72.24

Network Distribution Modules



ONQDA1002

ONQDA1002	5-port 10/100 switch	56.75
ONQDA1004	4-port 10/100 router	77.46
ONQDA1008	8-port 10/100/1000 switch	173.95

Wireless Access Points



ONQDA1101

ONQDA1101	802.11n Wireless Access Point	208.46
-----------	-------------------------------	--------

Broadcast Intercom System

ONQIC1400-**	Intercom four location kit (includes module, white main, 3 white room units, chime board & power supply)	635.62
ONQIC1002-**	Intercom module and main console	389.13
ONQIC1004-**	Intercom room unit, indoor	58.35
ONQF7596-??	Intercom door unit, outdoor	39.24
ONQF7641-??	Intercom patio unit, outdoor	77.86
ONQF9018-BK	Intercom desktop unit, black	93.19
ONQF9018-SR	Intercom desktop unit, silver	93.19
ONQF7601	Door chime	37.89
ONQIC1001	Intercom audio interrupt module	78.61
ONQPW7725	12V, 2.5A power supply	48.44
ONQIC1000	Intercom module (standalone)	245.49



ONQIC1400



ONQIC1004



ONQF7596



ONQF7641



ONQF9018

** Available Colors - WH-White, LA-Light Almond, ??-Available Colors - AB-Antique Brass, BS-Brushed Stainless, OB-Oil Rubbed Bronze, SB-Shiny Brass, WH-White

Cat 5e Camera System



ONQCM1011



ONQCM1029



ONQF2299



ONQCM1003

ONQCM1011	Cat 5e camera module	82.43
ONQF2284	Bullet camera B/W, outdoor/indoor	132.89
ONQF2286-WH	Decorator mount mini camera, B/W	117.24
ONQCM1029	Color IR camera	123.65
ONQF2299	Bullet camera color, outdoor/indoor	176.88
ONQF7642	Cat 5e camera microphone	37.98
ONQCM1003	LCD display module	59.03
ONQF2213	BNC to RCA cables (bag of 5)	33.16
ONQF2217	RCA to RCA cable, 90 degree	5.42
ONQF2218	RCA to RCA "Y" split, 90 degree	6.87
ONQF2221	RJ45 to quad RCA audio cable	20.20

See page 174 for Legrand Unity.

1000 Series Speakers



ONQMS1650

ONQ364764-02-V1	6.5" In-ceiling (pair)	54.02
ONQHT5651	6.5" In-wall (pair)	83.23
ONQMS1652-V1	6.5" In-ceiling dual voice coil (ea)	62.45
ONQHT1655-V1	Angled in-ceiling (each)	37.35
ONQMS1652-V1	6.5" In-ceiling dual voice coil (each)	62.45
ONQMS1655**-V1	6.5" dual voice coil Stereo Rock Speaker (each)	86.18

** Color Options SL=Slate ST=Sandstone

3000 Series Speakers

ONQMS3650	6.5" In-ceiling (pair)	77.03
ONQMS3800	8" In-ceiling (pair)	129.90
ONQMS3651	6.5" In-wall (pair)	124.08
ONQ364657-02	8" In-wall (pair)	78.71
ONQMS3652	6.5" In-ceiling dual voice coil (each)	72.35
ONQMS3523-WH	5.25" Outdoor, white (pair)	84.93
ONQMS3523-BK	5.25" Outdoor, black (pair)	84.93



ONQMS3650



ONQMS3651



ONQMS3652



ONQMS3523-BK

5000 Series Speakers

ONQHT5650	6.5" In-ceiling (each)	68.37
ONQHT5800	8" In-ceiling (each)	73.64
ONQHT5651	6.5" In-wall (each)	83.23
ONQHT5801	8" In-wall (each)	99.00
ONQHT5104	10" 150 Watt amplified subwoofer (each)	248.19
ONQHT5655	6.5" Angled in-ceiling (each)	62.99



ONQHT5650



ONQHT5651



ONQHT5104



ONQHT5655

Speaker Accessories

ONQ364672-02	6.5" In-ceiling (pair)	14.06
ONQ364673-02	8" In-ceiling (pair)	14.06
ONQ364674-02	6.5" In-wall (pair)	28.03
ONQ364675-02	8" In-wall (pair)	31.21
ONQAC0065-V1	Square speaker adapter bracket	10.95



ONQ364672-02



ONQ364674-02

Decorator lyriQ Cat 5 Audio System Kits

The lyriQ Multi-Room Audio System is the perfect solution for high performance whole-home audio. Systems are based on efficient Cat 5 wiring and feature convenient RJ45 connections for easy install. The Classic line utilizes decorator-style wallplates and is available in either single source or multi-source versions.



ONQAU1003



ONQAU1005

ONQAU1003-**	4-source kit w/ keypads	918.81
ONQAU1005-**	4-zone kit w/ HP keypads	1022.61
ONQAU1012-**	Single-source/4-zone w/keypads & flush input	756.19

** Kits & Components are available in WH-White and LA-Light Almond

lyriQ Cat 5 Audio System Components



ONQAU1002



ONQAU7396



ONQAU7398



ONQAU7428



ONQAU1004



ONQF7417



ONQAU1000



ONQAU7394



ONQF7399

ONQAU1002	4-source/8-zone module (requires 2 PW1060 power supplies)	201.99
ONQAU7396	Single-source/4-zone module (requires 1 PW1060 power supply)	90.49
ONQAU7398	Single source input, surface-mount	105.03
ONQAU7428	Triple source input, surface-mount	121.18
ONQAU1004-**	Single source input, flush-mount	105.03
ONQF7417-**	Local source input	67.06
ONQAU1000-**	Classic keypad	150.78
ONQAU7394-**	Classic High Performance (HP) keypad	120.34
ONQF7399-**	Classic amplified knob volume control with IR	88.88
ONQF7425	Dual IR Mouse emitter	12.29

Home Theater Accessories

ONQHT2102-WH-V1	Flat Panel Connection Kit	22.82
ONQHT2103-WH-V1	Home Theater Connection Kit	40.77
ONQWP9009	7.1 Home Theater Connection Kit	29.04



ONQHT2102



ONQHT2103



ONQWP9009

lyriQ Cat 5 Audio System

The lyriQ Multi-Room Audio System, available in the stylish Studio Design, delivers high performance sound at the touch of a button. Installed easily via Cat 5 wiring, lyriQ systems are available in multi-source or single source versions. Each multi-source system can control up to eight zones of audio with the ability to cascade additional modules for larger installations.

ONQAU5544-WH	Kit: 4-AU5009-WH, 1-AU5008-WH, 1-AU1011-WH, 1-AU1004-WH, 1-AU1002, 1-AU1060, 2-F7425, 1-PW1060	1044.34
ONQAU5744	lyriQ Multi-Source Charge & Play Four-Zone Kit in Studio Design Kit: 4-AU5009-WH 1-AU5015, 1-AU5008-WH, 1-AU1011-WH, 1-AU1002, 1-AU1060, 1-F7425, 1-PW10601-WP5001-WH, 1-WP5002-WH	974.22
ONQAU5714	lyriQ Charge & Play Four-Zone Kit in Studio Design Kit: 4-AU5009-WH, 1-AU5008-WH 1-AU5015, 1-AU1014, 1-PW1060	830.58
ONQAU5514-WH	Kit: 4-AU5009-WH, 1-AU5008-WH, 1-AU1004-WH, 1-AU7396, 1-AU1060, 2-F7425, 1-PW1060	922.12
ONQAU5008-**	Studio lyriQ local source	76.05
ONQAU1011-**	lyriQ flush-mount triple source input	121.18
ONQAU5009-**	Studio lyriQ keypad with studio plate	148.62
ONQAU1015	lyriQ airQast Main Source	193.86
ONQAU5015	lyriQ Charge & Play Kit	124.90

**Color-WH-White, LA-Light Almond



ONQAU5544-WH

ONQAU5008

ONQAU5009

Studio Cat 5 Camera System

ONQCM5451-WH	Kit: 1-CM5002-WH, 1-CM1011, 1-HA5000-WH, CM1010, 1-F2217, 1-PW1060, 1-F7726	946.48
ONQCM5002-WH	Studio single-gang ball camera	219.51
ONQHA5201-WH	TV display interface	194.14
ONQHA5000-WH	7" LCD console	410.03
ONQCM1010	LCD/TV display interface module	130.52
ONQCM1011	Cat 5 camera module	82.43
ONQCM1026	Ball camera microphone	37.98



ONQCM5451-WH



ONQHA5000-WH



ONQCM5002-WH



ONQHA5201-WH



ONQCM1010

Studio Selective Call Intercom System



Seamlessly blending leading edge technology with stunning design, Selective Call is the most advanced intercom in the industry. The system allows broadcast or room-to-room communication at the touch of a button and enables up to three simultaneous, private conversations - the only intercom in the industry to do so. And it's all based on efficient Cat 5 wiring.

ONQIC5400-**	Kit: 4-IC5000-**, 1-IC5001, 1-PW1030	912.84
ONQIC5000-**	Intercom room unit	199.63
**- WH-White, LA-Light Almond		
ONQIC5001	Selective Call module	251.04
ONQIC5002-*	Intercom door unit	149.11
ONQIC5003-*	Intercom video door unit	345.75
ONQIC5004-*	Intercom patio unit	155.63
ONQIC5006-BK	Surface mount box for outdoor units	14.76

*-AB-Antique Brass, BS-Brushed Stainless, OB-Oil-Rubbed Bronze, SB-Shiny Brass, WH-White

Retrofit Audio/Video Solutions

ONQHT2001-WH-V1	HDMI Pass-through Wallplate Kit	40.77
ONQHT2002-WH-V1	Component Video/Digital Audio In-Wall Kit	58.32
ONQHT2004-WH-V1	Dual Access Cabling Kit	15.84
ONQAU5901-WH-V1	Single Room Audio Kit	195.93



ONQAU5015-WH

ONQTM8USBWCC6

ONQAU5901-WH-V1

New MP3 Player/Smartphone Solutions

ONQAU5015-WH	Charge & Play Kit, White	138.21
ONQTM8USBWCC6	Dual USB Charger with Receptacle	Call
ONQAU5901-WH-V1	In-Wall MP3 Player System. Includes: keypad, stereo source input, universal player desktop stand, power supply. Just add a source and speakers.	195.93

Studio Collection Wallplates

ONQWP5001-**	Single-gang	4.08
ONQWP5002-**	Two-gang	7.14
ONQWP5003-**	Three-gang	10.19
ONQWP5004-**	Four-gang	12.90

**Color - AL-Aloe, BD-Bordeaux, CP-Cameo Pink, CM-Cement, CT-Citrus, CZ-Cozumel, CY-Cyan, GB-Gloss Black, KK-Khaki, LA-Light Almond, MS-Moss, NV-Nirvana, SD-Sand, SP-Spanish Red, TP-Taupe, TI-Titanium, WH-White

Unity System

System Features

- Up to six cameras per system
- Up to eight LCDs or TV displays per system with expansion (TV displays can be shared for even more interfaces)
- Up to 32 intercom units per system
- System can be expanded for up to 16 audio zones
- All units self-discover when connected to power
- No programming required, easy personalization options
- Select and play music or view live camera feeds on Smartphone and tablet devices
- Access to thousands of free Internet radio stations
- Support for lighting, HVAC, messaging, events, and more

One System – Complete Control

The Integration Module is a dedicated home systems controller designed to tie the home's camera, intercom, lighting, and audio systems together to work as a unified system. The integration module generates the graphical user interface that homeowners will come to know as their Unity Home System.

The Homeowner View

A graphical user interface allows homeowners to see into and control their Unity Home System. Its intuitive user interface allows users to effortlessly place room-to-room calls through the intercom system, adjust music playing throughout the home, raise and lower lighting, or view the front door camera, all with the press of a button.



ONQHA6401-BS

ONQHA6401-BS 3-room Unity kit

2915.62

Includes:

- 1 x HA6001
- 1 x HA5000
- 2 x IC5000
- 1 x IC5003
- 1 x AU1014
- 1 x AU1004
- 2 x AU5009
- 1 x AU1060
- 1 x F7425

Interfaces		
ONQHA6001	Unity integration module	1395.68
ONQPW1100	24VDC, 3.5A power supply for HA6001	148.13
ONQHA5000-**	7" LCD console	410.03
ONQHA5009-**	7" LCD console with integrated lyriQ Audio	613.51
ONQHA5010-**	7" LCD console with integrated lyriQ high-performance audio	680.95
ONQHA5201-**	Television interface module	194.14

Audio Expansion		
ONQAU1002	4-source/4-zone lyriQ hub	201.99
ONQAU5009-**	lyriQ studio keypad	148.62

Network Interface		
ONQDA1004	4-port Ethernet router/switch	77.46

Intercom Expansion		
ONQIC5001	Selective Call intercom 8 location hub	251.04
ONQIC5000-**	Selective Call room unit	199.63

Camera Expansion		
ONQCM1011	Cat 5e camera module	82.43
ONQCM5002-**	1-gang ball camera	219.51

Speakers for Audio		
ONQMS3650	3000 Series 6.5" in-ceiling speaker (pair)	77.03
ONQMS3651	3000 Series 6.5" in-wall speaker (pair)	124.08

** - WH-White, TI-Titanium, and LA-Light Almond

Compatible with Selective Call intercom units, Cat 5 camera system, and lyriQ audio system. See page 173 for additional add-ons.

The Unity Home System – Intercom, Lighting, Camera, and Multi-Room Audio in One Convenient Package

- Easy-to-use graphical interface displays location and current weather
- Customizable screen options include Studio Collection colors
- Shortcut buttons allow easy access to options based on current screen



Control music volume anywhere in the home with the touch of a button

LCD becomes an intercom unit when connected to the Integration Module

Navigation arrows allow users to easily access cameras, intercom, multi-room audio and messaging functions



ONQHA5009-GB



ONQHA5009-TI



ONQHA5009-WH



ONQIC5000-XX



ONQAU5009-XX



ONQIC5003-XX
See Page 173



ONQCM5002-XX









Keystone Insert Wallplates



ONQWP3401	ONQWP3402	ONQWP3403	ONQWP3404	ONQWP3406
ONQWP3410	ONQWP3411	ONQWP3412	ONQWP3413	ONQWP3414
ONQWP3401-**-	Single-gang wallplate, 1-port	0.69		
ONQWP3402-**-	Single-gang wallplate, 2-port	0.69		
ONQWP3403-**-	Single-gang wallplate, 3-port	0.69		
ONQWP3404-**-	Single-gang wallplate, 4-port	0.69		
ONQWP3406-**-	Single-gang wallplate, 6-port	0.69		
ONQWP3212-**-	Two gang wallplate, 12-port	3.45		
ONQWP3467-SS	Phone (insert not included), steel	2.04		
ONQWP3467-WH	Phone (insert not included), white	2.04		
ONQWP3410-**-	Decorator strap, blank	0.51		
ONQWP3411-**-	Decorator strap, 1-port	0.75		
ONQWP3412-**-	Decorator strap, 2-port	0.75		
ONQWP3413-**-	Decorator strap, 3-port	0.75		
ONQWP3414-**-	Decorator strap, 4-port	0.75		
ONQWP3416-**-	Decorator strap, 6-port	0.75		

** Available Colors - WH-White, IV-Ivory, LA-Light Almond (additional colors available, call for stock)

Keystone Wallplate Inserts

	ONQWP3425-**-	RJ25 6 position/6 cond.	1.71
	ONQWP1234-**-	HDMI to HDMI	8.12
ONQWP3425	ONQWP3450-**-	Cat 5e RJ45 T568-A/B	2.26
	ONQWP3458-**-	Cat 5e Keyed RJ45	2.82
ONQWP3481	ONQWP3451-**-	Cat 5e RJ45 coupler	4.46
	ONQWP3460-**-	Cat 6 RJ45 T568-A/B	4.18
ONQWP3479	ONQWP3479-**-	Nickel "F"	0.80
	ONQWP3481-**-	Nickel recessed "F"	1.04
ONQWP3479	ONQWP3480-**-	Gold recessed "F"	1.20
	ONQWP3482-**-	Self-terminating gold recessed "F"	2.39
ONQWP3456	ONQWP3455-**-	Blank insert (bag of 10)	2.14
	ONQWP3457-**-	Binding posts, pair	4.22
	ONQWP3456-**-	Single speaker insert	2.82
	ONQWP3461-**-	White RCA to "F"	2.06
	ONQWP3462-**-	Red RCA to "F"	2.06
ONQWP3457	ONQWP3463-**-	Green RCA to "F"	2.06
	ONQWP3464-**-	Blue RCA to "F"	2.06
	ONQWP3465-**-	Yellow RCA to "F"	2.06
ONQWP3461	ONQWP3466-**-	Purple RCA to "F"	2.06

** Available Colors - WH-White, IV-Ivory, LA-Light Almond (additional colors available, call for stock)

Decorator Wallplates and Inserts

ONQWP1205-**-	1-gang decorator	0.24
ONQWP1207-**-	2-gang decorator	0.47
ONQWP1208-**-	3-gang decorator	2.65
ONQWP1194-**-	1-gang wallplate, blank	0.54
ONQWP3501-WH	1-port surface box, white	0.90
ONQWP3502-WH	2-port surface box, white	1.12
ONQWP3409-**-	1-gang surface mount box	1.85
ONQWP1000-**-	3-port phone/data strap	6.79
ONQWP2002-**-	Single gang 6p6c RJ25 phone	3.26
ONQWP1011-**-	Pre-configured HDMI 2-port	16.99
ONQWP3210-**-	Pre-configured 1-port, 1 RJ45	3.55
ONQWP3211-**-	Pre-configured 2-port, 1 RJ45, 1 "F"	4.56
ONQWP3220-**-	Pre-configured 2-port, 2 RJ45	6.26
ONQWP3422-**-	Pre-configured 4-port, 2 RJ45, and 2 "F"	8.31
ONQWP1010-**-	Pre-configured component video strap	21.75
ONQWP1014-WH	Cable access strap, white	4.01
ONQF9006-**-	Single speaker strap	5.36
ONQF9005-**-	Dual speaker strap	14.94
ONQF7661-**-	5.0 Home theater 2-gang decorator	29.39
ONQF9004-**-	5.1 Home theater outlet straps	28.54
ONQWP3483-01	Banana jacks (1 pair)	3.47

** Available Colors - WH-White, IV-Ivory, LA-Light Almond (Additional Colors Available, Call for Stock)

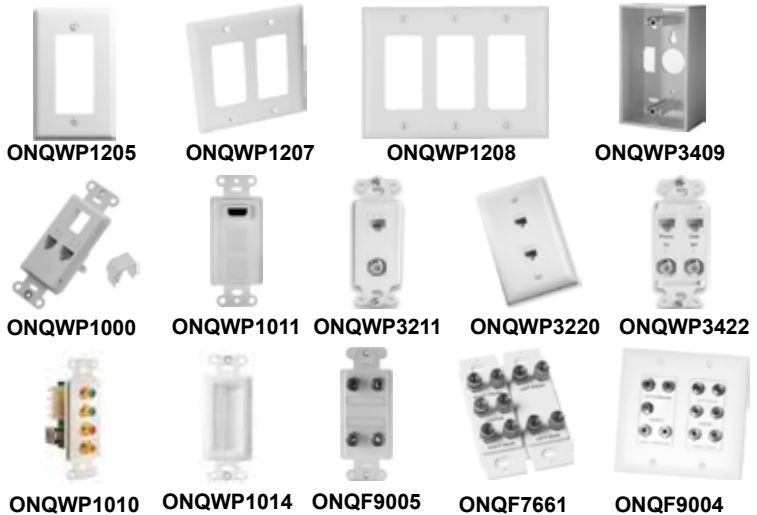

Low-Voltage Construction Brackets

ONQAC1009-01	Single-gang with nail, new construction	0.74
ONQAC1009-02	Double-gang face mount, new construction	1.24
ONQAC1010-01	Single-gang LV bracket, retrofit	0.95
ONQAC1010-02	Double-gang LV bracket, retrofit	1.29
ONQAC1010-03	Triple-gang LV bracket, retrofit	1.56



50" Enclosure



CVC-0150E

Enclosures include screws, grommets, wire management straps, cable identifiers & cardboard rough-in cable protector

CVC-0150E	50" Enclosure only	89.93
CVC-0150D	50" Smoke hinged door	135.08
CVC-0150HC	50" Hinged cover only	39.97

Cover and enclosure are sold separately.

38" Enclosures

Enclosures include screws, grommets, wire mgmt straps, cable identifiers & cardboard rough-in cable protector.

CVC-0138E	38" Enclosure only	62.71
CVC-0138D	38" Smoke hinged door	115.63
CVC-0138DD	38" Hinged double door	19.98
CVC-0138HC	38" Hinged cover only	30.23

Cover and enclosure are sold separately.



CVC-0138DD

12" Enclosures



CVC-0112E

Enclosures include screws, grommets, wire mgmt straps, cable identifiers & cardboard rough-in cable protector.

CVC-0112C	12" Cover only	12.64
CVC-0112E	12" Enclosure only	23.98

RF Splitters

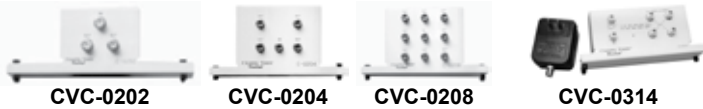

CVC-0202	1x2 RF splitter, 5-1000MHz, 3.5dB loss	7.56
CVC-0204	1x4 RF splitter, 5-1000MHz, 7dB loss	11.24
CVC-0208	1x8 RF splitter, 5-1000MHz, 11dB loss	17.74
CVC-0314	1 in 4 out splitter, DC/IR passing	45.96
CVC-0333	2x8 w/ active return path, FIOS compatible	109.09
CVC-0332	1 in 16 out amp 1dB gain, DC/IR passing	67.95

Data Network Modules



CVC-0538	Cat 6 network module 8 Port, 110 x 8, RJ45	38.97
CVC-0554	Wireless router with 4 ports - 802.11N	76.94
CVC-0532	Data/patch module; includes (2) C-0538 & (1) C-0519	139.40
CVC-0588	8-port gigabit Ethernet switch	64.95
CVC-0622	Fiber optics plate with lid and coupler	24.98

Enclosure Accessories

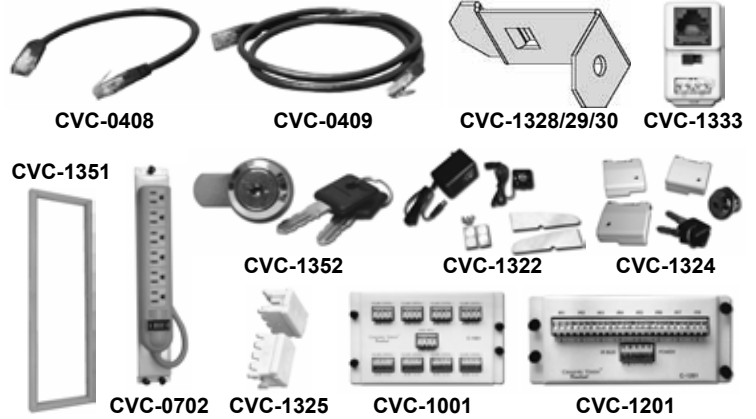

CVC-0408	Cat 5e, RJ45 interconnect, 1'	1.00
CVC-0409	Cat 5e, RJ45 interconnect, 3'	1.20
CVC-1328	Mounting clips for 3/8" drywall - 4 pc/bag	2.60
CVC-1329	Mounting clips for 1/2" drywall - 4-pc/bag	2.60
CVC-1330	Mounting clips for 5/8" drywall - 4-pc/bag	2.60
CVC-1333	RJ31X module	2.50
CVC-1351	50" depth extension ring	48.50
CVC-1352	Replacement angled latch for 28" and 38"	2.21
CVC-1322	Fan kit for designer doors	19.98
CVC-1324	Universal hinge kit (3 pc)	12.43
CVC-1325	Strain relief clips	0.11
CVC-0702	Bracket and power strip; 6 outlets	13.99
CVC-1001	Speaker module 2 pair in x 8 pair out	49.96
CVC-1201	IR distribution, 8 in 1 out wire	29.98

Telephone Distribution Modules

CVC-0410	4 CO-line surge protector module	29.98
CVC-0432	110-punch, 4x8 telephone w/ RJ31x	40.52
CVC-0434	KSU phone distribution module	60.63
CVC-0436	RJ45, 4x8 telephone w/ RJ31x	33.06
CVC-0437	RJ45, 4x12 telephone w/ RJ31x	36.20
CVC-0438	4x7 locations	19.98
CVC-0439	4x15 locations	34.97
CVC-0441	110 telecom module - 100 pair w/ RJ31x	35.97
CVC-0497	Converts 25 pair telco to RJ11	19.85
CVC-0498	Octopus cable, use w/ Panasonic TA-824	16.54
CVC-0499	KSU expansion PCB	35.28

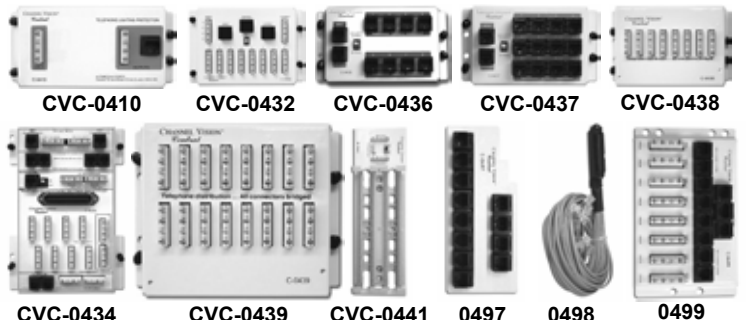

RF Modulation with Digital Cable



CVP-0328

- Easy Source Switching between Cable and Modulator
- Combines Cable TV with Modulated Signals
- Eliminates Cable Interference without Filters
- Eliminates Call Backs
- RF Amplifier Unity Gain on All Outputs

CVP-0321	2x1 Affinity module, CATV or Digital CATV in and 1 modulator input	78.94
CVP-0328	3x8 Affinity module, CATV or Digital CATV in and 2 modulator inputs, output to up to 8 locations	174.86
CVA-0511	Mini Remote control for use with Affinity modules, requires IR-4101	5.00

Adapters

CV2105	Female "F" connector to male BNC connector	0.75
CV2107	Female "3-way" connector	1.84
CV2108	Female BNC "splice" connector	0.70
CV2115	Female "F" connector to male UHF connector	1.10
CV2120	2 female, 1 male BNC "T" connector	1.02
CV2123	Male BNC "right angle" connector	1.80
CV2126	Female "F" connector to RCA male connector	0.87
CV2127	Female RCA connector to BNC male connector	0.77
CV2129	Female BNC connector to RCA male connector	0.75
CV2203	Male "F" to male "F" connector "coupler"	0.77

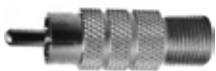

CV2126



CV2127



CV2129

IP Cameras/NVR

CV6564	2MP megapixel (1080p) outdoor IP dome camera with IR, weatherproof/vandal proof, varifocal 3-9mm lens, PoE, analog/IP video simultaneously	366.71
CV6543	2MP megapixel (1080p) outdoor IP bullet camera with IR, weatherproof/vandal proof, varifocal 3-16mm lens, PoE, analog/IP video simultaneously	366.71
CV6530	1.3MP megapixel (720p) indoor IP dome camera, 4.2mm lens, PoE, event triggered micro SD recording	157.87
CV6524	1.3MP megapixel (720p) indoor IP flush mount camera, 4.2mm lens, PoE, event triggered micro SD recording, includes double gang box and tinted faceplate	197.84
CVW4001	H.264 4-Channel Video Server, PoE	398.68
CVNVR4-1000	4-Channel NVR with 1TB Hard Drive for recording above IP cameras	553.56



CVNVR4-1000



CV6564



CV6543

Accessories and Infrared Devices

CVIR-5000	All-in-one IR system, includes plasma proof IR receiver with built-in connecting block, 4 emitters	64.45
CVIR5010	Long distance plasma proof IR kit for distances up to 1000 feet	76.44
CVIR-2400	Remote head IR receiver, plasma proof, small footprint receiver for hidden applications	51.87
CVIR-2005	J-box IR receiver, mounts in a single gang low-voltage mud ring	53.48
CVIR-1203	Amplified IR hub, 4 emitter ports, status LED's, screw term. or mini plug. PS included, req. emitters	23.08
CVG-IRB-W	Snap-in insert for structured wiring plate, converts 3-conductor IR wiring to 3.5mm jack	2.25
CVIR-4101	Receiver with IR over coax injector, use with Affinity modules to switch sources	31.72

CV-IR5000

By keeping the IR-5000 on your truck, you can stock one kit for nearly every IR application. Receiver is CFL, LCD and plasma proof and the kit includes options for surface, stick-on and recessed-mounting.



CVIR-5000



CVG-IRB-W

Accessories and Infrared Devices

CVHS2	2-way splitter/combiner	4.58
CVHS3	3-way splitter/combiner	6.28
CVHS4	4-way splitter/combiner	8.24
CVHS6	6-way splitter/combiner	16.94
CVHS8	8-way splitter/combiner	19.73
CVHS16	16-way splitter/combiner	39.82



CVHS2

iPod/iPad On-Wall Docks



CVA-0602

when needed for portable use. When the iPad is removed, it becomes the perfect place to display your favorite photo.

Transform your Apple iPad® into a cost-effective wireless on-wall touchscreen panel with Channel Vision's newest On-Wall Dock. With this dock, the iPad securely mounts to the wall creating a touchscreen controller ideal for home theater, whole-house automation, security, and AV applications. Be able to mount your iPad horizontally or vertically and easily remove the tablet

CVA0602	On-wall dock for iPad, easily remove iPad for portable use, mounts vertically or horizontally, charges iPad (does not support devices with Lightning Connector)	147.88
---------	---	--------

The Channel Vision Wall-Dock Station for iPod for Distributed Audio supports RS-232 and IR control. The dock connector easily adjusts to fit any iPod and has a non-skid pad to help keep the music player secure. With its elegant and contemporary styling, it fits into any home setting and provides the convenience of accessing an iPod from anywhere in the home.

CVA0316	On-wall dock for iPod with IR and RS-232 control, video out, charges iPod (does not support devices with Lightning Connector)	194.84
CVA0505	IR remote control for use with A-0316	11.99

Keystone Plates - Standard Size

DAT20-300+*	Keystone plate, choose color and # of ports	0.51
*AL-Almond, BK-Black, BR-Brown, GY-Gray, IV-Ivory, LA-Lt Alm., WH-White		
+1-1-Port, 2-2-Port, 3-3-Port, 4-4-Port, 5-5-Port, 6-6-Port		

Décor Plate Insert

DAT20-51+*	Keystone insert, choose color and # of ports	0.75
*5-Almond, 3-Ivory, 2-White		
+4-1-Port, 5-2-Port, 6-3-Port, 7-4-Port		

Keystone Inserts

DAT20-3425-**	Cat 5e data jack, 10 year	1.29
DAT20-3102-*	Jack w/ "F" connector	0.44
DAT20-3104-WH	RCA to "F", white only	1.87

* AL-Almond, IV-Ivory, LA-Lt Alm., WH-White - Other Colors Available

Low/Line Voltage Cable Plate

DAT45-0021	Recessed w/ recessed power	13.68
DAT45-0022	Kit with Locking Inlet	83.62
DAT45-0023	Kit with Straight Blade Inlet	43.65



DAT45-0021

Low Voltage Cable Plate

DAT45-0001-*	1-gang recessed	1.56
DAT45-0002-*	2-gang recessed	2.31
DAT45-0003-WH	3-gang recessed, white only	4.37
DAT45-0060	5.1 Surround 2-gang plate	20.61
DAT45-0008	Easy mount, retrofit	2.37
DAT45-0009-*	Easy mount, slim fit, retrofit	2.37



DAT45-0003



DAT45-0009

*BR-Brown, LA-Light Almond, WH-White

BNC Connectors, Adapters, and Splitters

DAT41-0010	BNC male right angle clamp RG59U	1.49
DAT41-0015	BNC male right angle clamp RG6U	1.49
DAT41-0050	BNC "T" type adapter three female	0.90
DAT41-0052	BNC "T" adapter 1 male 2 female	0.60
DAT41-0055	BNC double female adapter	0.37

DAT41-0060	BNC male to RCA male	0.80
DAT41-0065	BNC male to RCA female	0.50
DAT41-0070	BNC male to F female	0.65
DAT41-0075	BNC female to F male	0.57
DAT41-0080	BNC female to RCA male	0.54



DAT41-0010/15



DAT41-0050



DAT41-0052



DAT41-0055



DAT41-0060



DAT41-0065



DAT41-0070



DAT41-0075



DAT41-0080

CATV Accessories



Modulators

CP5415HD	1-input QAM modulator for RGB/Digital Audio	642.40
----------	---	--------

RGB and Coaxial/Optical input allows you to modulate cable boxes and other HD (up to 720p) sources on the QAM spectrum. A Notch or Low Pass filter is still required to "blank" out the channel range you want to modulate onto. For composite video sources, a scaler would be required.

Supports QAM channels 2.1 to 135.1



CP5415HD

CP5415	1-input digital modulator, CATV 65-125 & UHF 14-64, set-top	54.81
CP5515	1-input digital modulator with 12VDC IR, CATV 65-125 & UHF 14-64, set-top	74.10
CP5425	2-input digital modulator, CATV 65-125 & UHF 14-64, set-top	93.33
CP5525	2-input digital modulator with 12VDC IR, CATV 65-125 & UHF 14-64, set-top	121.57
CP5435	3-input digital modulator, CATV 65-125 & UHF 14-64, set-top	117.53
CP5445	4-input digital modulator, CATV 65-125 & UHF 14-64, set-top	151.13
CP5545	4-input digital modulator with 12VDC IR, CATV 65-125 & UHF 14-64, set-top	193.35

RF Amplifiers

CPDA500A	RF amplifier, 18dB gain, 55dB max out, 100MHz bandwidth	53.67
CPDA550BID	RF amplifier, bi-directional CATV, 3 in/8 out, IR (12VDC) engine, 115VAC, use w/2132 target	170.98
CPDA550HHR	RF amplifier, hi-headroom for off-air, 3 in/8 out, IR (12VDC) engine, 115VAC, use w/2132 target	164.41

Filters

CPLPF-380	Low-pass filter, Ch 2-50 (380MHz)	19.67
CPNF-469	Notch filter, Ch 64-70 (469-497MHz)	25.47
CPLPF-470	Low-pass filter, Ch 2-64 (470MHz)	20.86
CPLPF-600	Low-pass filter, Ch 2-86 (600MHz)	30.69
CPLPF-750	Low-pass filter, Ch 2-116 (750MHz)	30.69
CPV902	Satellite/terrestrial diplexer	10.43

Miscellaneous

CP2501	Blocking capacitor, in-line, "F" type	1.44
CP2503	Attenuator, in-line, 3dB "F" type	1.77
CP2506	Attenuator, in-line, 6dB "F" type	1.77
CP2507	Terminator, 75Ω, "F" type	1.31
CP2509	Tap/combiner, 9dB drop, 1dB thru loss	2.30

F-Conn Universal Compression Connectors (Connectors sold in 5-packs, priced each)

F Connector

ICMFSNS6U	RG6, Nickel	0.44
ICMFSNS59U	RG59, Nickel	0.44

RCA Connector

ICMFSNS6RCAU	RG6, Nickel	1.22
ICMFSNS59RCAU	RG59, Nickel	1.22

BNC Connector

ICMFSNS6BNCU	RG6, Nickel	2.12
ICMFSNS59BNCU	RG59, Nickel	2.12



FSNS6RCAU



FSNS59BNCU



FSNS6U



FSNS6BNCU

Right-Angle Connectors (Connectors sold in 5-packs, priced each)

ICMFS6URA	Right-angle F for RG6, Nickel	1.95
ICMFS59URA	Right-angle F for RG59, Nickel	1.95
ICMFSBNC6URA	Right-angle BNC for RG6, Nickel	2.89
ICMFSBNC59URA	Right-angle BNC for RG59, Nickel	2.89
ICMFSRCA6URA	Right-angle RCA for RG6, Nickel	2.49
ICMFSRCA59URA	Right-angle RCA for RG59, Nickel	2.49

Requires ICMLMTIP-RA tip in ICMCPLCCT-SLM tool for compression.

Color Bands

ICMFSCR*	Universal color bands for F, RCA, and BNC (bag of 100)	3.75
----------	--	------

*R-Red, W-White, Y-Yellow, B-Blue, G-Green, BK-Black, O-Orange, P-Purple

Cable Pro and F-Conn are the choice of professionals

ICM Corp.'s TRUE 360° compression connectors and tools work together as a complete integrated system. One easy-to-use Cable Pro tool is able to compress a variety of F-Conn F, RCA, and BNC type connectors to fit RG59, RG6, mini coax, and a variety of plenum size cable.

Professional Compression Tools and Accessories

ICMCPLCCT-SLM	Linear compliant compression tool, solid steel construction, includes four tips to compress nickel and gold, right angle and splice connectors in F, RCA, and BNC. Compatible with Leviton and OnQ connectors.	88.77
ICMLMTIP-RA	Tip for use with right-angle connectors in SLM compression tools	2.39
ICMLMTIP-WP	Tip for use with wallplate snap-in connectors in SLM compression tools	2.39
PT15030C	2-level coaxial cable stripper for RG-59/6/Mini Coax. Be sure to use the FIT6 Flaring and Insertion tool for easier termination.	10.45
ICMFIT6	Flaring and Insertion tool, used to separate the cable jacket for easier installation of the F connector. Also folds back foil and braiding.	10.94
ICMCPPT-1	Pocket Toner, loud audio tone identifies line carrying signal	21.87



ICMCPLCCT-SLM



ICMFIT6



ICMCPPT-1



PT15030C

Mini-Coax Connectors (Connectors sold in 5-packs, priced each)



ICMFS1RCA
ICMFS15RCA



ICMFS1BNC
ICMFS15BNC

ICMFS1BNC	Mini-Coax BNC connector for 25-26ga wire. Great for component video. Orange.	2.09
ICMFS1RCA	Mini-Coax RCA connector for 25-26ga wire. Great for component video. Orange.	1.67
ICMFS15BNC	Mini-Coax BNC connector for 22-24ga wire. Great for component video. Purple.	2.09
ICMFS15RCA	Mini-Coax RCA connector for 22-24ga wire. Great for component video. Purple.	1.67
ICMFS15	Mini-Coax "F" connector for 22-24ga wire - 5pk.	0.76

One piece connectors listed, call for multi-piece connectors.

Speaker Compression Connectors (Connectors sold in 4-packs, priced each)

ICMRGSPU	Speaker connector for 12, 14, 16 AWG wire, includes black/red color rings, requires wire tips - Each	1.68
ICMRGSPURA	Right angle speaker connector for 12, 14, 16 AWG includes black/red color rings, requires wire tips - Each	2.52
ICMRGSPB	Banana tip, for RGSPU/RGSPURA use with banana jack connections - Each	1.14
ICMRG SPL	Spade tip, for RGSPU/RGSPURA use with binding post connections - Each	1.32
ICMRGSP	Angled Pin tip, for RGSPU/RGSPURA use with spring clip connections - Each	1.21
ICMRG SBPOST	Female speaker binding post, includes 2 posts (1 red and 1 black), screw tip, 12-16ga inserts	4.54

Splice Connectors (Connectors sold in 5-packs, priced each)

ICMFS6US	RG6 F splice, Nickel	1.04
ICMRG6US	RG6 F splice, Gold	1.44
ICMFS59US	RG59 F splice, Nickel	1.04
ICMRG59US	RG59 F splice, Gold	1.44
ICMFS6RCAUS	RG6 RCA splice, Nickel	1.27
ICMRG6RCAUS	RG6 RCA splice, Gold	1.69
ICMFS59RCAUS	RG59 RCA splice, Nickel	1.27
ICMRG59RCAUS	RG59 RCA splice, Gold	1.69
ICMFS1RCASST	25-26ga Mini-Coax RCA splice, Nickel	2.09
ICMRG1RCASST	25-26ga Mini-Coax RCA splice, Gold	2.52
ICMFS15RCASST	22-24ga Mini-Coax RCA splice, Nickel	2.09
ICMRG15RCASST	22-24ga Mini-Coax RCA splice, Gold	2.52
ICMFS6BNCUS	RG6 BNC splice, Nickel	2.12
ICMRG6BNCUS	RG6 BNC splice, Gold	2.71
ICMFS59BNCUS	RG59 BNC splice, Nickel	2.12
ICMRG59BNCUS	RG59 BNC splice, Gold	2.71
ICMFS1BNCSSST	25-26ga Mini-Coax BNC splice, Nickel	2.10
ICMRG1BNCSSST	25-26ga Mini-Coax BNC splice, Gold	2.55
ICMFS15BNCSSST	22-24ga Mini-Coax BNC splice, Nickel	2.10
ICMRG15BNCSSST	22-24ga Mini-Coax BNC splice, Gold	2.55

Splice connectors give maximum flexibility in creating custom wiring installations.

Insert Modules (Universal insert for structured wiring, priced each)

HIPUAM	Use with splice connectors, Almond	0.06
HIPUIM	Use with splice connectors, Ivory	0.05
HIPUKM	Use with splice connectors, Black	0.06
HIPULAM	Use with splice connectors, Lt. Alm.	0.05
HIPUWM	Use with splice connectors, White	0.06

Color O-Rings (Use with RCA/BNC splices, priced in 100 bag)

HIPOB	Blue, specifies insert as the Blue channel of an RGB connection	1.25
HIPOG	Green, specifies insert as the Green channel of an RGB connection	1.25
HIPOK	Black, specifies insert as a Subwoofer connection	1.25
HIPOO	Orange, specifies insert as a Digital Coaxial Audio connection	1.25
HIPOP	Purple, specifies insert as a Subwoofer connection	1.25
HIPOR	Red, specifies insert as the Red channel of an RGB connection or as the Left channel of Line Level Audio	2.50
HIPOW	White, specifies insert as the Right channel of Line Level Audio	1.87
HIPOY	Yellow, specifies insert as a Composite Video connection	1.87

Create a Splice (Follow these three steps to create a complete unit)

1.) Splices
1.) Choose a splice

- "F", RCA or BNC
- RG6, RG59 or Mini-Coax
- Nickel or Gold

2.) Insert Modules
2.) Choose an insert module

- Almond or Light Almond
- Ivory
- White or Black

3.) Color O-Rings
3.) Add Color O-Rings

- HIP rings for splices
- ICM rings for connectors
- Call with any questions

Starter Kits

ICMSTARTERKIT	Universal starter kit, selection of tools, connectors, color bands, inserts and more	199.40
ICMSLMPKSAKIT	Basic starter kit, includes ICMCPLCCT-SLM and PSA59/6 strip tool	96.49
ICMDBPSAKIT	Double Bubble starter kit, includes Double Bubble compression tool and stripper	80.41
ICMDBSTARTER	Double Bubble starter kit, includes compression tool, stripper and a selection of assorted connectors	154.38

Double Bubble 360 Tools and Connectors

ICMCPLCRBC-B	Double Bubble compression tool-Blue	70.76	ICMDB6U	F connector for RG6	0.30
ICMCPLCRBC-ITS	Double Bubble specialty compression tool	70.76	ICMDB6PL2	F connector for RG6 Plenum	0.30
			ICMDB6RCAU	RCA connector for RG6	1.06
			ICMDB6RCAPL2	RCA connector for RG6 Plenum	1.06
			ICMDB6BNCU	BNC connector for RG6	1.67
			ICMDB6BNCPL2	BNC connector for RG6 Plenum	1.67
			ICMDB59U	F connector for RG59	0.30
			ICMDB59PL2/4	F connector for RG59 Plenum	0.30
			ICMDB59RCAU	RCA connector for RG59	1.06
			ICMDB59RCAPL2/4	RCA connector for RG59 Plenum	1.06
			ICMDB59BNCU	BNC connector for RG59	1.67
			ICMDB59BNCUPL24	BNC connector for RG59 Plenum	1.56

ICMCPLCRBC-B

ICM DB Connectors, F, RCA, BNC

RHINO 6000 Hard Case Kit



DM1734520

- PC-compatibility lets you download/upload and print labels from your PC
- Over 250 pre-programmed industry terms and symbols, plus storage for 1000+ custom labels
- "Hot Keys" instantly format wire wrap, flags, patch panel labels, fixed length labels and more
- Uses RHINO labels up to 1" wide
- Includes RHINO 6000 printer, hard carry case, two labels (1734524, 18443), AC adapter, rechargeable battery pack, RHINO CONNECT software (1738636), and USB cable

DM1734520	RHINO 6000 Hard Case Kit, see above	291.43
DM1734519	RHINO 6000 Printer, incl. label (1734524), AC Adpt. (15519) and Rech. Battery (1738637)	208.17
DM1738636	RHINO CONNECT Software, print from your PC to your 6000 or 6500 printer and more	166.53

RHINO 5200 Hard Case Kit



DM1756589

- "Hot Keys" instantly format wire wraps, patch panel and fixed length labels and more
- Prints Code 39 and Code 128 bar codes
- Smart on-screen alerts; 100 memory locations
- Uses RHINO labels up to 3/4" wide
- Includes RHINO 5200 printer, hard carry case, two labels (18489, 18443), AC adapter/charge and rechargeable lithium-ion battery

DM1756589	RHINO 5200 Hard Case Kit, incl. 1755749, 18489, 18443, 15519, 1760413 and rechargeable lithium-ion battery	179.86
DM1755749	RHINO 5200 printer only	127.69

RHINO 4200 Printer



DM1835374

- Easy to navigate QWERTY keyboard
- "Hot Keys" instantly format wire wraps, flags, fixed length labels and more
- Uses RHINO labels up to 3/4" wide
- Adds "Favorites" and "Custom" keys to increase labeling productivity and reduce labeling time

DM1801611	RHINO 4200 Printer	77.71
DM1835374	RHINO 4200 Printer Kit. Includes 4200 Printer, AC Adapter, Case, Labels	135.30

RHINO Labels - Buy 4 Get 1 Free!

- Industrial-strength adhesive for labels that stick and stay stuck
- Split-back design for easy application

Part No.	Material	Size	Color	Price
Flexible Nylon - Wire/cable, flat, curved, rough or smooth surfaces				
DM18488	Flexible Nylon	1/2"	White	17.64
DM18489	Flexible Nylon	3/4"	White	19.50
DM1734524	Flexible Nylon	1"	White	21.34
DM18490	Flexible Nylon	1/2"	Yellow	17.64
DM18491	Flexible Nylon	3/4"	Yellow	19.50
DM1734525	Flexible Nylon	1"	Yellow	21.34

Heat Shrink Tube - Best labeling solution for wires/cables

DM18051	Heat Shrink Tubing	1/4"	White	33.78
DM18053	Heat Shrink Tubing	3/8"	White	36.37
DM18055	Heat Shrink Tubing	1/2"	White	38.96
DM18057	Heat Shrink Tubing	3/4"	White	41.57
DM18052	Heat Shrink Tubing	1/4"	Yellow	33.78
DM18054	Heat Shrink Tubing	3/8"	Yellow	36.37
DM18056	Heat Shrink Tubing	1/2"	Yellow	38.96

Dymo LabelWriter

DM1752264	LabelWriter 450, desktop mailing label printer	132.68
DM1752265	LabelWriter 450 Turbo, desktop mailing label and postage printer	187.32
DM1752266	LabelWriter 450 Twin Turbo, desktop mailing label and postage printer, dual printer	284.88
DM1752267	LabelWriter 450 Duo, same as 1752265, second printer allows for printing on RHINO labels	289.41
DM1744905	LabelWriter 4XL, desktop shipping and other large format label printer, up to 4" wide	390.25
DM30915	STAMPS labels, 200/box	23.81
DM30253	Large address labels, 1-1/8" x 3-1/2", 700/box, White	22.67
DM30330	Return address labels, 3/4" x 2", 500/box, White	14.06
DM1744907	Shipping labels, 4" x 6", 220/box, White	25.96
DM30911	Time expiring adhesive name badge labels, 2-1/4" x 4", 250/box, White	37.42
DM1750630	Print Server for network sharing of LabelWriters	171.71

Manage your operations easier with these label printers from Dymo.



DM1752264 **DM1752266** **DM1752267** **DM1744905**

Part No.	Material	Size	Color	Price
Vinyl - Use for indoor/outdoor applications, great for curved surfaces				
DM18444	Vinyl	1/2"	White	15.20
DM18443	Vinyl	3/8"	White	15.20
DM18432	Vinyl	1/2"	Yellow	15.20
DM18433	Vinyl	3/4"	Yellow	17.03
DM1805416	Vinyl	1/2"	Red	15.20
DM1805422	Vinyl	3/4"	Red	17.03
DM1805435	Vinyl	1/2"	Black	15.20

Other Vinyl Colors/Sizes available. Call for details.

Permanent Polyester - Ideal for flat, smooth or textured surfaces				
DM18482	Permanent Polyester	3/8"	White	15.20
DM18483	Permanent Polyester	1/2"	White	15.20
DM18484	Permanent Polyester	3/4"	White	17.03
DM1734523	Permanent Polyester	1"	White	19.12
Self-Laminating - Ideal for wire/cables				
DM1734821	Vinyl Self Laminating	1"	White	20.95

Category Wire (UTP) Termination

	PT100008	EZ-RJ-45® Combo 24, includes crimp tool and 24 Cat 5/5e connectors	57.33
	PT100004	EZ-RJ-45 crimp tool	46.46
	PT100054C	EZ-RJ-45 heavy duty professional crimp tool for Cat 5/5e, Cat 6 and RJ-11/12 connectors	65.16
	PT100003C	EZ-RJ-45 Cat 5/5e connectors, 50 pieces	0.47
	PT100010C	EZ-RJ-45 Cat 6+ connectors, 50 pieces	26.68
	PT100026C	EZ-RJ12/11 connectors, 50-piece clamshell, use with EZ-RJPRO crimp tool	0.27
	PT202035J	Strain relief for Cat 5/5e EZ-RJ-45 connectors, 100 piece jar	0.18
	PT202036J	Strain relief for Cat 6 EZ-RJ-45 connectors, 100 piece jar	0.18
	PT13001	66 style blade for 13006C	10.45
	PT13002	110 style blade for 13006C	10.45
	PT13006C	Punchdown impact tool w/ 110 blade	34.47
	PT13007C	Punchdown impact tool w/ 110 and 66 blades	43.47
	PT15015	Cat 5 cable jacket stripper	8.96
	PT90121	Twisted pair/coax kit includes 100004, 15015, 13006C, 15030C, 10500 and 11020	126.65

Miscellaneous Tools/Connectors

	PT10500	Coax and round wire cable cutter	6.96
	PT15030C	2-level coaxial cable stripper for RG-58/59/62/6/6 Quad/Mini Coax	10.45
	PT10510C	BTP-6 coax and data cable cutter, multi-size elliptical cutting lobes	14.95
	PT10711C	Professional drywall saw, high carbon steel blade	9.70
	PT15310	Maxim 6 heavy duty self adjusting wire stripper, 24-10AWG stripping range, 30-10AWG cutting range	54.67
	PT15003C	ProStrip 10/20 wire strippers	10.85
	PT15010C	Stripper for plenum jacket, NYC code firewire, speaker wire, fiber and more	22.44
	PT12100	Connector pressing telecom pliers, use with model 18110 connectors	11.22
	PT11020	"F" connector tool, use for inserting compression connectors	10.70
	PT19016	16-in-1 security screwdriver, 16 different bits for the security installer	20.95
	PT19101	33-piece precision screwdriver set	15.70
	PT13022	Punchdown tool extension (66 and 110), great for structured wiring punchdowns	13.45
	PT13021	66/110 combo blade, cutting blade for 66 and 110 blocks	10.45
	PT18110	Telecom splicing connectors for splicing into existing phone lines	0.11
	PT12507C	Tele-Titan Modular Crimping Tool, use with RJ11, RJ12 and RJ45, not for use with EZ-RJ connectors	26.19

EZ-SnapJacks (Connectors sold in 10-packs, priced as each)

PT705*-1	Cat 5/5e, bulk, bagged	2.89	PT706**-1	Cat 6, bulk, bagged	3.13
*AL-Almond, BK-Black, BL-Blue, BR-Brown, GN-Green, IV-Ivory, LA-Light Almond, OR-Orange, RD-Red, WH-White or YL-Yellow			**AL-Almond, BK-Black, BL-Blue, BR-Brown, GN-Green, IV-Ivory, LA-Light Almond, OR-Orange, RD-Red, WH-White or YL-Yellow		



EZ-SnapJacks

First the EZ-RJ45®, now the EZ-SnapJack! You may never again need a punchdown tool. At least for your wall jacks! The patented EZ-SnapJack is self-terminating and quickly installs for professional results in a snap.

- Save time – No need for eight punch downs
- Repair damaged jacks on the spot
- EZ-SnapJacks are re-useable
- Wire guide ensures pairs stay in proper order for fast, easy termination
- Reduced tool cost, no PDT required
- Your tool bag weighs less
- Available for Cat 5e and Cat 6
- Designed to fit industry standard wallplates
- Commercial network installations, new or retrofit
- Home automation installations, new or retrofit

Testers

PTT104C	4Mapper coax tester, troubleshoot/identify	37.32	PTT129K1	VDV MapMaster Kit	162.33
	• EZ 1-button design			<p>The VDV 2.0 MapMaster combines continuity testing, mapping, tone generation and length measurement functions in a single tester. This kit includes the tester and all the accessories required for voice, data and video testing & mapping in the field. It's packaged in a rugged double-walled, blow-molded case with custom cut out, high density EVA foam to help protect your equipment for years to come.</p>	<p>PTT129K1</p>
	<p>• Displays Pass, Open or Short</p> <p>• Integrated tone generator</p> <p>• Automatic power off</p> <p>• Line voltage warning LED</p> <p>• Flashing low battery LED</p> <p>• Ultra bright, high intensity LED's, easy to see in the daylight</p> <p>• Includes 4 custom F remotes, push-on design</p> <p>• Small, compact, fits in the palm of the hand</p> <p>• Long battery life</p>				

Plastic Push-In Connectors for Metal Enclosures



AIINM940

Part #	Description	Box Qty.	Each Price
AIINM940	Connector for 3/8" knockout	100	0.12
AIINM95	Connector for 3/4" knockout	50	0.20
AIINM96	Connector for 1" knockout	50	0.20

Low Profile Outdoor Weatherproof Line Voltage Box



AIIDBVR131*

AIIDBVS1*	New siding	4	10.58
AIIDBVM1*	Stucco	4	8.32
AIIDBVR1*	Retrofit	4	10.58
AIIDBVR131*	Retrofit siding 1/4"-5/16" Lap	4	12.09
AIIDBVR141*	Retrofit siding 1/2" Lap	4	12.09
AIIDBVR151*	Retrofit siding 5/8" Lap	4	12.09
AIIDBVR171*	Retrofit siding dutch Lap	4	12.09

*Available Covers: C-Clear, W-White

Outdoor Weatherproof While-In-Use Line Voltage Box



AIIDBPV1

AIIDBPV1	Dri-box w/ cover, base, and wallplate, vertical, 1-gang	4	9.07
AIIDBPH1*	Same as above but horiz.	4	9.07
AIIDBP2*	Dri-box w/ cover & base w/ wall plate, vertical, 2-gang	4	15.49

*Available Covers: C-Clear, No Suffix-White

Dual Voltage Device Box



AIILVDR2

AIILVD2	Power and low voltage box for new construction	25	2.64
AIILVDR2	Power and low voltage box for existing construction	25	3.38

Line Voltage Box



AIIF102

AIIF101	1-gang for new construction	50	1.42
AIIF102	2-gang for new construction	25	2.16
AIIF103	3-gang for new construction	50	3.04
AIIF104	4-gang for new construction	10	5.05
AIIF202N	2-gang for dryers and ranges; nail-on	10	2.56
AIIF202S	2-gang for dryers and ranges; screw-on	10	2.56

In/Out Box - Adjustable Outlet Box 1/2" - 1 1/2"



AIIFA101

AIIFA101	1-gang, non-metallic	25	1.96
AIIFA102	2-gang, non-metallic	10	2.52
AIIFA103	3-gang, non-metallic	10	4.50
AIIFA104	4-gang, non-metallic	1	5.62

Line Voltage Box Extenders



AIIBE1

AIIBE1	1-gang for old construction	25	1.00
AIIBE1R	Round ceiling box extender for old construction	25	1.66
AIIBE2	2-gang for old construction	25	1.32
AIIBE3	3-gang for old construction	25	2.75
AIIBE4	4-gang for old construction	25	3.77

Recessed Duplex Receptacle Box



AIIDVFR1W

Part #	Description	Box Qty.	Each Price
AIIDVFR1W	1-gang with retrofit box	4	6.18
AIIDVFR2W	2-gang with retrofit box, for power or low-voltage	4	9.62

Recessed TV Box



AIITVB613



AIITVBU505



AIITVL508

AIITVB613	13" wide box fits in 16" O.C. studs for horizontal or vertical installation	1	11.24
AIITVBS613	Same as above but steel	1	28.10
AIITVBU505*	2-gang - duplex receptacle kit with retrofit line/low box - *BL-Black	1	8.74
AIICED130	TV box w/slotted cover	1	1.87
AIITVL508	Low-Profile TV Box for shallow wall depths, great for Flat TVs	1	13.43
AIITVBRA1K	1-gang TV Bridge Kit	1	42.34
AIITVBRA2K	2-gang TV Bridge Kit	1	52.08

Garden Posts

AIIGP19*	19.5" post for GFCI outlet	6	22.18
AIIGP26*	26" post for GFCI outlet	6	37.45
AIIGPD19*	19.5" post for GFCI outlet w/ in-use cover	6	19.96
AIIGPBK35*	35" post with bollard light fixture	1	134.88
AIIGPD9*	9" deck mount for GFCI outlet/light fixture	1	19.96
AIIGP37*	37" post for GFCI outlet/light fixture	4	56.45
AIIGPX18*	18" extender for above post	4	30.24
AIIGPL19*	19.5" low profile post for light fixtures	6	15.13
AIIGPI75*	Up to a 75 watt flood light for posts	4	23.91
AIIGPF13*	13 watt fluorescent flood light	4	42.32
AIIGPP60*	Pagoda-style light fixture; style 1	4	25.34
AIIGPP60L*	Pagoda-style light fixture; style 2	4	28.04

*Available in B-Black and BR-Bronze-Other Colors Available; Call for Pricing



AIIGP19

AIIGPD19

AIIGPBK35

AIIGPD9

AIIGP37

AIIGPL19



AIIGPI75



AIIGPF13



AIIGPP60



AIIGPP60L

Line Voltage Boxes







		Box Qty.	Ea. Price
CARB122A	1-gang box with nails 3 1/2" depth, 22 cubic in.	100	0.79
CARB232A	2-gang box with nails 3" depth, 32 cubic in.	50	1.71
CARB455AH	4-gang box with nails 2 1/2" depth, 60 cubic in.	25	7.25
CARB120R	1-gang box, old work case, 3 5/8" depth, 20 cubic in.	50	3.03
CARB225R	2-gang box, old work case, 2 3/4" depth, 25 cubic in.	30	5.45
CARB355R	3-gang box, old work case, 3 11/16" depth, 55 cubic in.	6	10.03
CARB520A	Ceiling box with nails, 4" dia., 20 cubic in.	75	1.97

Flexible Electrical Non-metallic Tubing



Part No.	Color	Nom. I.D.	Nom. O.D.	Min. Bend Radius	Coil Length (ft.)	Wt. per 100 ft. (lbs.)	Price
CAR12005-200	Blue	0.56	0.84	6"	200	10	0.58
CAR12005Y-200	Yellow	0.56	0.84	6"	200	10	0.68
CAR12005R-200	Red	0.56	0.84	6"	200	10	0.69
CAR12007-100	Blue	0.76	1.05	6"	100	14	0.82
CAR12007Y-100	Yellow	0.76	1.05	6"	100	14	0.94
CAR12007R-100	Red	0.76	1.05	6"	100	14	1.04
CAR12008-100	Blue	1	1.315	6"	100	22	1.23
CAR12008Y-100	Yellow	1	1.315	6"	100	22	1.42
CAR12008R-100	Red	1	1.315	6"	100	22	1.53

Flexible Electrical Non-metallic Tubing Accessories







		Carton Qty.	Price			Carton Qty.	Price
CARA240D	1/2" ENT quick connector adapter	100	0.98	CARE943D	1/2" ENT male term. adapter	150	0.26
CARA243D	1/2" ENT quick connector threaded adapter	100	1.48	CARE940E	3/4" ENT standard coupling	100	0.24
CARA253D	1/2" ENT quick connector snap-in adapter	100	1.04	CARE943E	3/4" ENT male term. adapter	125	0.42
CARA240E	3/4" ENT quick connector adapter	100	1.29	CARE940F	1" ENT standard coupling	50	0.37
CARA243E	3/4" ENT quick connector threaded adapter	100	2.65	CARE943F	1" ENT male term. adapter	50	0.57
CARA253E	3/4" ENT quick connector snap-in adapter	100	1.84				
CARA240F	1" ENT quick connector adapter	100	2.43				
CARA243F	1" ENT quick connector threaded adapter	100	4.22	CARA240D	CARA243D	CARA253D	CARE943D
CARA253F	1" ENT quick connector snap-in adapter	100	2.82				CARE940F
CARE940D	1/2" ENT standard coupling	150	0.19				

The Box/Carton Quantities are Noted for Reference Only. No Minimum Purchase is Required.

Low-Cost Alternatives

Line Voltage Accessories for the Home

Power Strips/Remote Control/Work Lights

					
BL215001	BL215002	BL215010	BL215024	BL210430	BL215025
BL215001	6 outlet strip with surge, 3' cord, 15A, 90J	4.02	BL215025	Remote controlled outlet, 120VAC, 10A	13.03
BL215002	6 outlet strip with surge, 6' cord, 15A, 90J	5.67	BL210430	Work light with 10' cord and metal guard	6.99
BL215010	6 outlet strip with surge, 12' cord, 15A, 90J	7.16	BL210422	Work light with 40' cord and metal guard	11.34
BL215024	3 outlet strip, non-surge, 8" cord, 13A	1.53			

Other Surge Strips Available. Call for Details.

Structured Cable Management Systems (No Upcharge for Broken Cases)

		Case	Each
AIINM904	Snap-in blank for knockouts, 1½", gray plastic	25	0.35
AIISB130	Bushing, non-metallic for metal studs, fits standard 1" knockout	100	0.19
AII4404	Snap-in bushing for knockouts, 1½", gray plastic	250	0.24
AIIBC25	1/4" beam clamp for use with the above two cable hangers	25	0.67
AIILV1	Low-voltage mounting bracket, old work, single gang, plastic, adj. ¼" - 1" walls	100	0.89
AIILVA1	Adjustable depth 1-gang Low-Voltage mounting bracket for new construction	25	1.81
AIILV1RP	Super sturdy low-voltage mounting bracket, old work, single gang, plastic, adj. ¼" - 1" walls	25	1.72
AIILV2	Low-voltage mounting bracket, old work, double gang, plastic, adj. ¼" - 1" walls	50	1.21
AIILVA2	Adjustable depth 2-gang Low-Voltage mounting bracket for new construction	10	2.31
AIILV2RP	Super sturdy low-voltage mounting bracket, old work, double gang, plastic, adj. ¼" - 1" walls	10	2.75
AIILV3	Low-voltage mounting bracket, old work, 3-gang, plastic, adj. ¼" - 1" walls	50	2.06
AIILV4	Low-voltage mounting bracket, old work, 4-gang, plastic, adj. ¼" - 1" walls	50	3.43
AIILVMB1	Low-voltage mounting bracket, new construction, single gang, plastic	100	0.67
AIILVMB2	Low-voltage mounting bracket, new construction, double gang, plastic	50	1.16
AIILVS1	Screw-on new construction bracket, single gang, low-voltage mounting bracket	50	0.46
AIILVN1	Nail-on new construction bracket, single gang, low-voltage mounting bracket	50	0.42
AIILVR1	Low-voltage mounting bracket, old work, round, plastic, adj. ¼" - 1" walls	25	1.35
AIIBE1	Single-gang box extender, add up to 1½" to boxes set back from wall surface	25	1.00
AIIBE2	Double-gang box extender, add up to 1½" to boxes set back from wall surface	25	1.32
AIISP100	Safety plate, flat 16 gauge steel, 1½" x 2¾"	100	0.16
AIIDVFR1W	Indoor IN BOX, recessed single gang box, great for kitchens/behind furniture	4	6.18
AIIDVFR2W	Indoor IN BOX, recessed double gang box, great for kitchens/behind furniture	4	9.62
AIITVB613	TV Box, recessed double gang electrical box with 2 low voltage knock outs	1	11.24
AIITVBU505	TV Box recessed power/low voltage box, old work. Includes box, receptacle, CEDH1 and wallplate	4	8.74
AIITVBU507*	TV Box, 3-gang recessed with one power and two low-voltage openings. *B-Black (leave off for White)	1	9.99
AIIT205	CableWay, cable runway support system, 5 foot trough for line or low voltage	10	10.90
AIIT23A	CableWay, cable runway support system, 90 degree fitting for corners	10	3.98
AIIT23C	CableWay, cable runway support system, coupling for joining T205	10	1.07
AIIT23E	CableWay, cable runway support system, end cap for terminating T205	10	0.86
AIIT23H	CableWay, cable runway support system, hanger bracket for T205	10	1.42
AIIT23T	CableWay, cable runway support system, "T" adapter	10	6.18

The Scoop Series Entrance Plates and Hoods

AIICE1	Single-gang, reversible-White	1.25	AIICE1BL	Single-gang, reversible-Black	1.25
AIICE2	Double-gang, reversible-White	1.81	AIICE2BL	Double-gang, reversible-Black	1.81
AIICER1	CE1 w/ removable plate-White	1.56	AIICER1BL	CE1 w/ removable plate-Black	1.56
AIICER2	CE2 w/ removable plate-White	2.19	AIICER2BL	CE2 w/ removable plate-Black	2.19
AIICED1	Single-gang reversible, decorator style-White	1.25	AIICED1BL	Single-gang reversible, decorator style-Black	1.25

Weatherproof Covers

AIIDBK88C	Weatherproof, non-metallic keypad enclosure, 7-1/4" x 7-3/4" x 1-1/2"-Clear	11.24
AIIDBK88W	Weatherproof, non-metallic keypad enclosure, 7-1/4" x 7-3/4" x 1-1/2"-White	11.24
AIIDBPH1C	Horizontal while-in-use cover for outlets-Clear	9.07

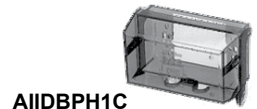

D-Rings

AIID22	Non-damaging wire management ring, 2.25" x 2"	1.01
AIID33	Non-damaging wire management ring, 3.25" x 3.25"	1.10
AIID35	Non-damaging wire management ring, 3.25" x 5"	1.46



Structured Cable Management Systems (No Upcharge for Broken Cases)

CARSC100A



CARSC300PRB

			Case	Each
	CARSC100A	Single-gang low-voltage bracket	24	1.10
	CARSC100ADJC	Single-gang adjustable low-voltage bracket, cut-off	24	2.79
	CARSC100RR	Single-gang old-work bracket, low-voltage	12	0.91
	CARSC200A	Dual-gang low-voltage bracket	24	1.69
	CARSC200ADJC	Dual-gang adjustable low-voltage bracket, cut-off	20	4.84
	CARSC200DV	Dual-gang dual-voltage box	16	1.75
	CARSC200RR	Dual-gang old-work bracket, low-voltage	6	2.09
	CARSC300A	Triple-gang low-voltage bracket	5	3.00
	CARSC300PRB	Triple-gang recessed dual voltage TV Bracket	20	12.50
	CARSC12CC	1/2" three wire stacking staples, 25 pack	10	5.10
	CARSC14CC	1/4" coaxial staple, 10 pack	10	7.13
	CARSC34CC	#6 SER (service entrance staple), bag of 10	20 Bags	5.49

Resi-Gard Adapters (No Upcharge for Broken Cases)

CARSCA243E

			Case	Each
	CARSCA240E	3/4" Resi-Gard quick connector adapter	25	0.80
	CARSCA243E	3/4" Resi-Gard quick connector threaded adapter	25	1.31
	CARSCA253E	3/4" Resi-Gard quick connector snap-in adapter	25	1.00
	CARSCA240F	1" Resi-Gard quick connector adapter	20	1.36
	CARSCA243F	1" Resi-Gard quick connector threaded adapter	20	1.75
	CARSCA253F	1" Resi-Gard quick connector snap-in adapter	20	1.52

Resi-Gard Conduit (No Upcharge for Broken Cases)

CARSC943J



CARVC9963SC

			Case	Each
	CARSCE4X1-100	3/4" Resi-Gard, 100'	1	0.52
	CARSCE4X1-1000	3/4" Resi-Gard, 1000'	1	0.47
	CARSCE977EC	3/4" Resi-Gard conduit clamp - 5 pack	20	1.63
	CARSCF4X1C-100	1" Resi-Gard with tape, 100'	1	0.68
	CARSCF4X1C-1500	1" Resi-Gard with tape, 1500'	1	0.53
	CARSCE977FC	1" Resi-Gard conduit clamp - 5 pack	12	2.90
	CARSCH4X1C-50	1 1/2" Resi-Gard with tape, 50'	1	0.98
	CARSCE977HC	1 1/2" Resi-Gard conduit clamp - 5 pack	6	3.25
	CARSCE940H	1 1/2" Resi-Gard standard coupling	25	0.63
	CARSCE943H	1 1/2" Resi-Gard male termination adapter	25	0.83
	CARSCJ4X1C-50	2" Resi-Gard with tape, 50'	1	1.34
	CARSCJ4X1C-500	2" Resi-Gard with tape, 500'	1	1.36
	CARSCE977JC	2" Resi-Gard conduit clamp - 5 pack	6	3.61
	CARSCE940J	2" Resi-Gard standard coupling	30	0.87
	CARSCE943J	2" Resi-Gard male termination adapter	50	1.10
	CARVC9963SC	Resi-Gard clear cement, pint	24	13.21

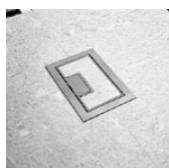
Floor Boxes

CARE9761*

			Case	Each
	CARE976RFB	Rectangular floor box base assembly	3	58.74
	CARE976AK2	Activation Kit 2, rectangular floor box	3	25.57
	CARE9761BR	Cover assembly, single, brass	3	202.51
	CARE9762BR	Cover assembly, double, brass	9	319.32
	CARE9762S	Cover assembly, double, slate	9	124.90
	CARE9763S	Cover assembly, triple, slate	6	162.37
	CARB121BFBR	Single-gang adjustable residential floor box	8	53.71
	CARB234BFBB	Dual-gang adjustable residential floor box	4	219.57

Tools

CARCC122

	CARCC120B	Small conduit cutter, for fast, smooth field cuts of 1/2" through 1" conduit		41.73
	CARCC122	Large conduit cutter, for clean cuts of 1/2" through 2" conduit		429.13

Enclosures

CARNC664	6x6x4 NEMA enclosure with external hinged cover-clear. Meets NEMA 1, 2, 3, 3S, 3X, 3SX, 4, 4X, 12 standards.	280.99
CARNC16146	16x14x6 NEMA enclosure with external hinged cover-clear. Meets NEMA 1, 2, 3, 3S, 3X, 3SX, 4, 4X, 12 standards.	320.11

Rain8 Pro2/Pro Irrigation Controllers



WGL41012
WGL41017

For HAI integration,
we recommend the
Pro UPB model

The Pro version includes the following new features: On/Off button for each zone, LED indicators for each zone, all valve wires/connections protected against lightning, all RS-232 and network connections are protected against ESD and lightning, and each output has a self-resetting electronic fuse. UPB adds support for both LINK and DIRECT modes.

WGL41012	Pro2 8-zone irrigation controller with serial interface, transformer, RS-232 cable	202.68
WGL41017	Pro2 8-zone serial irrigation controller expansion module	180.56
WGL41020	Pro 8-zone UPB irrigation controller, 20VA transformer, RS-232 cable, Gen 2 compatible	202.68
WGL41030	Pro 8-zone UPB irrigation controller expansion module	181.80

Rain8 Irrigation Controllers



WGL30005
WGL30004

WGL30005	8-zone 2-way X10 irrigation controller, 20VA transformer, RS-232 cable	104.33
WGL30004	8-zone 2-way X10 irrigation controller expansion module	95.96
WGL41050	8-zone irrigation controller with serial interface, transformer, RS-232 cable, does not use X10	115.97
WGL41055	8-zone serial irrigation controller expansion module	107.00
WGL41060	8-zone UPB irrigation controller, 20VA transformer, RS-232 cable, requires UPB PIM	125.84
WGL41065	8-zone UPB irrigation controller expansion module	112.16
WGL30018	Receives X10 RF signals and converts to RS-232, for use with PCs or Controller	60.69
WGL41032	Receives X10 RF signals and converts to RS-232 via a USB "Virtual" Comm Port	83.50

Accessories for Rain8/Rain8 Pro Irrigation Controllers

LSA36A00-1	Gen 2 UPB powerline interface module for use with WGL UPB irrigation controllers	65.98
LSA36A05-2	PIM to PC Cable. Modular to DB9 for connecting 36A00-1 to a computer	9.68

Relay8net - RS-232 Controllable Relays

WGL30062	8-zone independently operated relays, uses the same protocol as the Rain8net	168.55
MGT12500SPS	Replacement Power Supply for the Relay8	4.93
WGL10002	Replacement Data Cable for the Relay8	9.62
WGL80015	Replacement Terminal Strips for all Rain8/Relay8 products	7.08

Using the Rain8upb/Rain8upb Pro with an HAI Omni/Lumina Series Controller

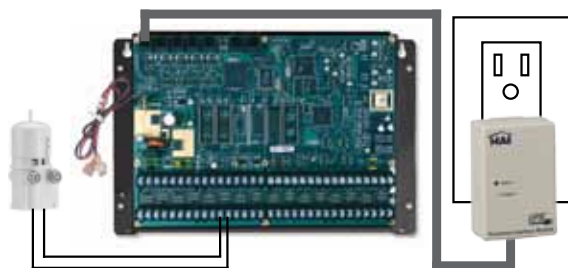

GH502 connected to a zone on an HAI with UPB PIM plugged into an outlet.

- Download Rain8 software from WGL
- Connect a Rain8upb/Rain8upb Pro to your PC and configure your Network ID, UPB device numbers and maximum allowed run times
- Program your HAI units for the number of valves you will be controlling
- Program your HAI flags for the desired run times for each valve
- Be sure to test your configuration

Visit www.worthingtonsolutions.com

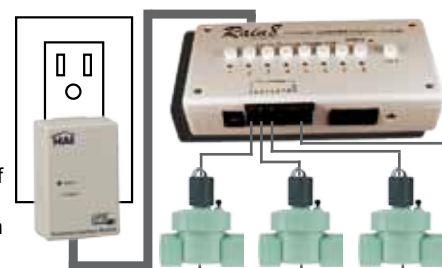

Rain8upb Pro connected to valves with UPB PIM plugged into an outlet.

Mini-Clik

Looking for other Mini-Clik products? Give us a call.

Mini-Clik Sensors



GH502

GHBP-SW	Bypass switch box w/ no-strip wire connectors & double-backed tape for mounting	20.13
GH401	Freeze sensor, 3° C (37° F) setpoint, 25' wire, screws, 24VAC, 6A	31.53
GH401R	Same as above but switches "On" instead of "Off"	29.23
GH502	Rain sensor, adjusts for rainfall of 1/8" to 1", includes 25' wire, aluminum mount	24.61
GH440200	Replacement Cap and Cork for GH502	4.73
GH601	Wind sensor, adjustable wind control, 12-35 mph shut down, 24VAC, 5A	104.74
GHSGM	Gutter Mount for Sensors	1.68

Landscape Lighting

Use landscape lighting to accent features of a property, light a path leading to a residence or out-building, provide safety for friends and family and more. Many shapes, sizes and styles are available to fit in with almost any decor. There are four steps to choosing and installing your landscape lighting.

- Choose the fixtures that you will be using
- Choose the correct size transformer
- Choose the proper low-voltage cable
- Install and enjoy



Landscape lighting can be controlled using Z-Wave, UPB or X10 and can be automated using your HAI Omni, HAI Lumina or ELK M1 Gold panel.

Flood Lights

Flood lights are used for lighting up an entire area with multiple lights or for highlighting a specific area. Different styles/colors are available to fit any landscape design. Not all models are shown. Please call for other available options.

MB8301-9601-01	50W halogen floodlight, black	13.74
MB8301-9602-01	20W halogen floodlight, black	10.60
MB8303-9606-01	35W halogen floodlight, sand	14.06



MB8302-9605-01



MB8301-9602-01



MB8301-9601-01

Path/Walk/Deck Lights

Path/walk lights are used to illuminate the areas that you want people to walk on as well as direct the flow of traffic. Path/walk lights also make a nice addition to gardens.

MB8301-2402-01	7W half brick deck light, black	8.81
MB8406-2403-01	2W LED half brick deck light, black	22.04
MB8421-2401-01	2W LED half brick deck light, copper	35.35
MB8301-9200-01	11W 6" tall path/driveway tier light, black	10.60
MB8301-9202-01	7W metal path/driveway tier light, black	8.02
MB8301-9300-01	20W halogen bollard light, black	10.68
MB8301-9301-01	10W halogen tulip style bollard light, black	9.97
MB8301-9400-01	7W round step deck light, black	5.97
MB8301-9501-01	20W halogen underwater pond light	22.21
MB8302-9107-01	18W mariner lantern, copper	20.33
MB8421-2420-01	2W LED round step deck light, copper	21.55
MB8303-9300-01	20W halogen bollard light, sand	10.54



MB8302-9107-01



MB8301-9200-01



MB8421-2420-01

Transformers

Transformer selection is one of the most important parts of specifying a low-voltage landscape solution. You have to make sure that you have enough power for your lights as well as the right type of transformer for the right situation.

MB8100-0200-01	200W transformer with timer, not for submersible lights	58.82
MB8100-0300-01	300W transformer with timer, can be used with submersibles	64.32
MB8100-0600-01	600W transformer with timer, two 300W circuits, use with submersibles	121.15
MB8100-0900-01	900W transformer with timer, three 300W circuits, can be used with submersible lights	186.10



MB8100-0200-01



MB8100-0300-01

Low-Voltage Cable

Available in 500' reels, landscape lighting wire is available if needed.

Selection of low-voltage cable is challenging but it's the most important step in your project. If you do not have the correct cable for the distance that you are running the lights, or you do not have the proper gauge cable for the amount of lights on the cable, you can have a major issue in the performance of your low-voltage landscape lighting solution. For example, use 12-gauge wire for shorter runs and use 10-gauge wire for longer runs.

Call for assistance.

WAVLLSC1202RBK2	500' reel of 12/2 low-voltage cable	174.86
WAVLSC1002RBK2	500' reel of 10/2 low-voltage cable	261.04

Wire can sometimes have a significant lead time; please be sure to allow adequate time for wire to be ordered in and delivered.



All-Climate Series

• 6.5" ACAD Driver • Cast Aluminum Basket • 20mm Titanium Dome Tweeter • 8 ohm • 125 W Power Handling • *=WHT-White, G-Green, B-Black	
TRAAC15*	AC15e w/ 5-way binding posts 197.05
TRAAC15X*	AC15e w/ Conxall® watertight connector 246.85
• 6.5" ACAD Driver • Cast Aluminum Basket • 1.1" Titanium Dome Tweeter • 8 ohm • 150 W Power Handling • *=WHT-White, G-Green, B-Black	
TRAAC16*	AC16e w/ 5-way binding posts 249.80
TRAAC16EX*	AC16e w/ Conxall® watertight connector 287.27
• Dual 6.5" ACAD Driver • Cast Aluminum Basket • 1.1" Titanium Tweeter • 8 ohm • 150 W Power Handling • *=WHT-White, G-Green, B-Black	
TRAAC17*	AC17e w/ 5-way binding posts 362.21
TRAACSUB*	Sub w/ 6' waterproof cable pigtail 780.62
• Sealed Molded Enclosure	
• 10" ACAD Driver	
• 12" Cast Frame Woofer	
	 <ul style="list-style-type: none"> • 2" Voice Coil • 250 W Power Handling • Can be 2/3 buried • *=G-Green, B-Black

HDMI over Cat 5e/Cat 6

Cat 5e distribution allows you to use inexpensive UTP wire to distribute HDMI to locations where the proper wire is either not available or not cost-effective. As signal quality increases Cat 6e becomes a better choice due to more bandwidth.



Pages 138-140

For all your cabling needs.

From 22/2 for security to RG6 for CATV/Satellite as well as direct burial wire for your landscape lighting, Wavenet has cable to fit almost all applications. Please call us if you have questions when specifying wire.



Pages 190-191

Are you looking for Fiber?

Leviton will manufacture custom-made fiber bundles with all connectors attached. They even attach the pull-sock. Prices are custom quoted, so please have your specs.



Call

Interconnect Cables

Connect all of your A/V gear with these quality cables. Different levels of quality are available to suit any customers' needs. Please give us a call with questions regarding what interconnect cables to use.



Page 142



Distributed Audio Systems

Run 16/4 and Cat 5 to the keypad and then 16/2 from there to each speaker you have prewired for C-Series, MRC88, M4, LyriQ, Hi-Fi 2 or A-BUS.

MRC88, M4, LyriQ, Hi-Fi 2 or A-BUS.



Telephone

Cat 5e has become the standard wire to run for both telephone and home networking.



Networking

Cat 6 is available for high bandwidth. Fiber is generally not used for networking at this time. Fiber can be used to connect two buildings.



Security

Most keypads are 22/4, but touchscreens are frequently looking for Cat 5. Use 22/2 for door/window sensors and 22/4 for powered devices, such as motion detectors and glass breaks.



Fire Alarm

Red fire-wire is required for code. For a home fire system, you must run fire wire to all fire detectors, fire alarm sounders, the transformer, keypads and powered devices.



Speaker Cable

Use 16-gauge for runs under 100' and 14-gauge for home theaters or runs over 100.'

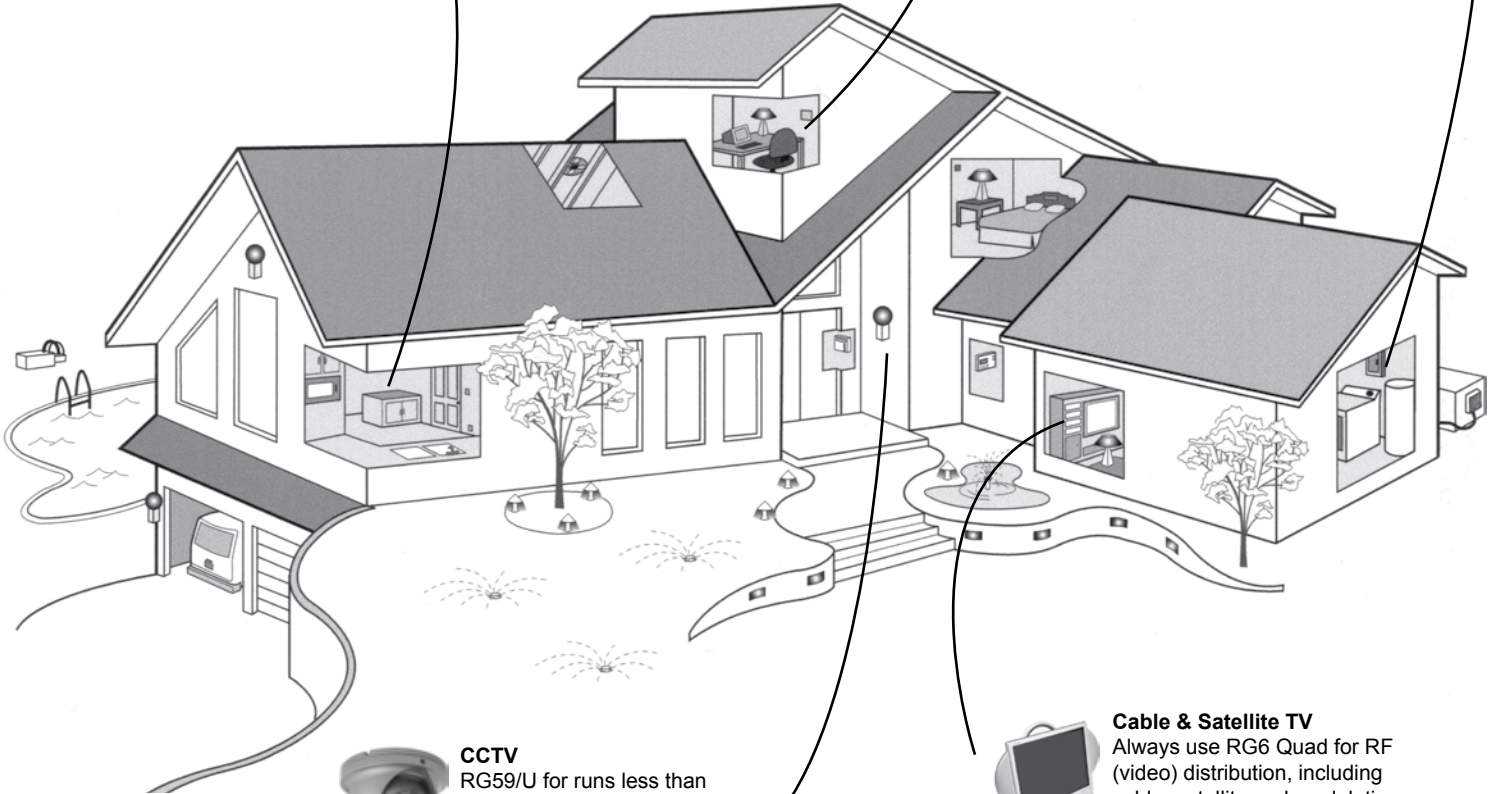

CCTV

RG59/U for runs less than 750 feet. RG6/U (solid copper center) for runs less than 1,500 feet. 18/2 is common for the power wire. If you are using baluns, you can use Cat 5e, up to 2200 feet.



Cable & Satellite TV

Always use RG6 Quad for RF (video) distribution, including cable, satellite and modulation. 3.0GHz is recommended.

Wire and Cable Ordering Options

Put-up and color availability vary by part (prices shown per 1000' unless otherwise noted)

Put-up (packaging) Last number in code: 1 = pull box, 2 = reel, 3 = reel in box [please note: reels (2) are charged additional "no-box fee" by UPS/FedEx]

** - Colors WH-(white), YL-(yellow), OR-(orange), GN-(green), BL-(blue), BK-(black), GY-(gray), PR-(purple), PK-(pink), RD-(red)



Wire pricing is always subject to change due to market fluctuations in copper.



Cat 5e for Network, Phone, Intercoms, etc.(1000' only)

WAV5E04UR**1	Cat 5e PVC: 24AWG, 4 pair, CMR, 350MHZ, 1000' pull box	(BK, BL,GN,GY, OR, PK, PR, RD, WH, YL)	69.94
WAV5E04UP**	Cat 5e Plenum: 24AWG, 4 pair, CMP, 350MHZ, 1000' reel in box	(BL, GN, GY, OR, RD, WH, YL)	166.12
WAV5E04SR**	Cat 5e Shielded PVC: 24AWG, 4 pair, CMR, shielded, 350MHZ,1000' pull box	(BL, GY, WH)	132.39
WAV5E04FP**3	Cat 5e Shielded Plenum: 24AWG, 4 pair, CMP, shielded, 350MHZ, 1000' reel in box	(BL, WH)	347.22
WAV5E04URBL1-S	Cat 5e Stranded PVC: 24AWG, 4 pair, CMR, stranded, 350MHZ,1000' pull box	(BL)	99.30
WAV5E0SPBK	Cat 5e Direct Burial: 24AWG, 4 pair, CMX, direct burial, 350MHZ, 1000' pull box	(BK)	112.41
WAV5E0SPBK2	Cat 5e Direct Burial: 24AWG, 4 pair, CMX, direct burial, 350MHZ, 1000' reel	(BK)	112.41
WAV5E25URGY2	Cat 5e 25 Pair PVC: 24AWG, 25 pair, CMR, Gray, 1000 reel	(GY)	627.00

Cat 6 for Network (1000' only)

WAV6E04UR**3	Cat 6 PVC: 23AWG, 4 pair, CMR, 550MHZ, 1000' reel in box	(BL, GN. GY, RD, WH, YL)	114.91
WAV6E04UP**3	Cat 6 Plenum: 23AWG, 4 pair, CMP, 550MHZ, 1000' reel in box	(BL, GN. GY, RD, WH, YL)	263.54
WAV6E04SR**	Cat 6 Shielded PVC: 23AWG, 4 pair, CMR, shielded, 550MHZ, 1000' reel in box	(BL, GY, WH)	163.62
WAV6E0SPBK2	Cat 6 Direct Burial: 23AWG, 4 pair, CMX, outdoor direct burial, 550MHZ, 1000' reel	(BK)	159.87

Broadband COAX

WAVRG6QR**1	RG6 Quad Shield PVC: 18AWG, quad shield, CCS, CMR, 3.0GHZ, 1000' box	(BK, WH)	57.45
WAVRG6QR**2	RG6 Quad Shield PVC: 18AWG, quad shield, CCS, CMR, 3.0GHZ, 1000' reel	(BK, WH)	57.45
WAVRG6QOSPBK2	RG6 Quad Shield Direct Bury: 18AWG, quad shield, CCS, CMR, 3.0GHZ, 1000' reel	(BK)	71.19
WAVRG6QPWH1	RG6 Quad Shield Plenum: 18AWG, quad shield, CCS, CMP, 3.0GHZ, 1000' box	(WH)	363.46
WAVRG6UR**1	RG6 60% Shield PVC: 18AWG, 60% shield, CCS, CMR, 3.0GHZ, 1000' box	(BK, WH)	44.96
WAVRG6UR**2	RG6 60% Shield PVC: 18AWG, 60% shield, CCS, CMR, 3.0GHZ, 1000' reel	(BK, WH)	44.96
WAVRG6OSPBK2	RG6 60% Direct Burial: 18AWG, 60% shield, CCS, CMX, outdoor direct burial, 3.0GHZ,1000' reel	(BK)	58.70
WAVRG6URWH1-BC	RG6 60% Bare Copper: 18AWG, 60% shield, bare copper, CMR, 3.0GHZ, 1000' box	(WH)	68.70
WAVRG11RBK2	RG11 PVC: 14AWG, 1.0GHZ, CMR, 1000' reel	(BK)	121.15

CCTV and RG59 COAX

WAVH59182NVR**2	RG59 + 18/2 (Siamese) PVC: RG59 95% bare copper + 18/2, siamese, CMR, 1000' reel	(BK, WH)	109.91
WAVH59182NVR**3	RG59 + 18/2 (Siamese) PVC: RG59 95% bare copper + 18/2, siamese, CMR, 500' reel in box	(BK, WH)	58.70
WAVRG59R**1	RG59 95% PVC: 20AWG, 95% bare copper, CMR, 3.0GHZ, 1000' BOX	(BK, WH)	76.19
WAVH59+182M**2S	RG59 + 18/2 (Siamese) PVC: RG59 95% bare copper + 18/2, siamese, CMR, 1000' reel	(BK, WH)	122.40
WAVH59+182M**2O	RG59 + 18/2 (Overall) PVC: RG59 95% bare copper + 18/2, overall, CMR, 1000' reel	(BK, WH)	72.44
WAVH59+182P**2	RG59 + 18/2 (Siamese) Plenum: RG59 95% bare copper + 18/2, siamese, CMP, 1000' reel	(WH)	358.46
WAVH59+182P**3	RG59 + 18/2 (Siamese) Plenum: RG59 95% bare copper + 18/2, siamese, CMP, 500' reel	(WH)	188.60

Would You Like Free Freight on Wire?

Order your wire in bulk (minimum order is \$3125.00) and get FREE ground freight shipping (drop shipped). You can mix Catagory 5, RG-6, Combination Cable, Speaker/Fire Alarm/Security Wire in the same order.

Always follow local, state, and national codes and adhere to professional wiring practices. Wire is not returnable.

Speaker Cable

WAVAC1402R**15	14/2 Audio Cable: 14AWG, 2C 105 strand oxygen free copper, 500' box	(BL, WH)	109.91
WAVAC1404R**15	14/4 Audio Cable: 14AWG, 4C 105 strand oxygen free copper, 500' box	(BL, WH)	214.83
WAVAC1602R**15	16/2 Audio Cable: 16AWG, 2C 65 strand oxygen free copper, 500' box	(BL, WH)	72.44
WAVAC1604R**15	16/4 Audio Cable: 16AWG, 4C 65 strand oxygen free copper, 500' box	(BL, WH)	129.90

Security Wire

WAVSC2202R**1	22/2 Solid: 22AWG/2C, CMR, 1000' box	(GY, WH)	33.72
WAVSC2202RWH1-S	22/2 Stranded: 22AWG/2C, CMR, 1000' box	(WH)	38.72
WAVSC2204R**1	22/4 Solid: 22AWG/4C, CMR, 1000' box	(GY, WH)	58.70
WAVSC2204R**1-S	22/4 Stranded: 22AWG/4C, CMR, 1000' box	(GY, WH)	69.94

Fire-Wire (Always Red)

WAVFC1802URD1	18/2 Fire Alarm Riser-rated: 18AWG/2C fire alarm, unshielded FPLR, 1000' box	(RD)	82.43
WAVFC1602URD1	16/2 Fire Alarm Riser-rated: 16AWG/2C fire alarm, unshielded FPLR, 1000' box	(RD)	121.15
WAVFC1402URD2	14/2 Fire Alarm Riser-rated: 14AWG/2C fire alarm, unshielded FPLR, 1000' reel	(RD)	192.35
WAVFC1804URD2	18/4 Fire Alarm Riser-rated: 18AWG/4C fire alarm, unshielded FPLR, 1000' reel	(RD)	168.62
WAVFC1604URD2	16/4 Fire Alarm Riser-rated: 16AWG/4C fire alarm, unshielded FPLR, 1000' reel	(RD)	258.54
WAVFC1802SRD1	18/2 Fire Alarm Shielded Riser-rated: 18AWG/2C fire alarm, shielded FPLR, 1000' box	(RD)	84.93
WAVFC1602SRD1	16/2 Fire Alarm Shielded Riser-rated: 16AWG/2C fire alarm, shielded FPLR, 1000' box	(RD)	124.90
WAVFC1402SRD2	14/2 Fire Alarm Shielded Riser-rated: 14AWG/2C fire alarm, shielded FPLR, 1000' reel	(RD)	212.33
WAVFC1804SRD*	18/4 Fire Alarm Shielded Riser-rated: 18AWG/4C fire alarm, shielded FPLR, 1000' reel	(RD)	189.85
WAVFC1604SRD2	16/4 Fire Alarm Shielded Riser-rated: 16AWG/4C fire alarm, shielded FPLR, 1000' reel	(RD)	282.27

*****Wire pricing is always subject to change due to market fluctuations in copper*****

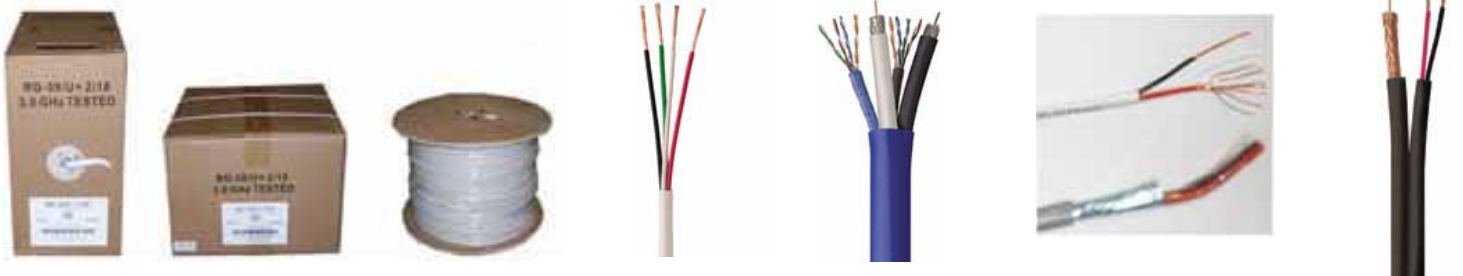

Order your wire in bulk (minimum order is \$3125.00.) and get FREE ground freight shipping (drop shipped).
You can mix Cat 5, RG-6, Combination Cable, Speaker/Fire Alarm/Security Wire in the same order.

Power Cables

WAVPW18SM**1	18/2 7-Strand Shielded PVC: 18AWG/2C, 7-strand, shielded, CMR, 1000' box	(GY, WH)	112.41
WAVPW18UM**1	18/2 7-Strand Unshielded PVC: 18AWG/2C, 7-strand, unshielded, CMR, 1000' box	(GY, WH)	96.17

Combination Cables

WAVH15E164MYL2	Cat 5e + 16/4 Audio Cable PVC: CAT 5e + 16/4 audio cable, CM, 500' reel	(YL)	189.85
WAVH15E16QMBL2	1 Cat 5e + 1 RG6Q PVC: Cat 5e + RG6Q, BLUE, 500' reel	(BL)	108.66
WAVH25E26Q2FYL2	2 Cat 5e + 2 RG6Q + Fiber PVC: Cat 5e + RG6Q + Fiber, 500' reel	(YL)	387.19
WAVH25E26QMBL2	2 Cat 5e + 2 RG6Q PVC: 2 Cat 5e + 2 RG6Q, 500' reel	(BL)	223.57
WAVH26E26QMGN2	2 Cat 6e + 2 RG6Q PVC: 2 Cat 6e + 2 RG6Q, 500' reel	(GN)	274.78



Need some low-voltage boxes and installation aids?
What about TV boxes and access plates?
Look at the wide selection from Arlington Industries on page 185



Are you looking for Fiber? Call us.
Leviton will manufacture custom-made fiber bundles with all connectors attached. They even attach the pull-sock. Prices are custom quoted, so please have your specs.

ORDERING: A toll free call to 1-800-282-8864 connects you to our knowledgeable sales team who seeks to provide you with the information, support and products you need to provide your clients with total solutions. We will gladly provide you with quotations, product information and technical assistance. Our business hours (Eastern Time) are 7:30 am to 6:00 pm Monday through Friday. **Orders can be placed 24 hours via toll free fax at 1-866-542-0470, on our after-hours voice mail order desk at our toll free number, 1-800-282-8864, at our secure dealer web site: www.worthdist.com, or by e-mail to sales@worthdist.com.** We do not have a minimum order.

SAME DAY SHIPPING: All orders placed by 4:00 pm Eastern Time (Monday - Friday) will be shipped the same day, F.O.B. Tafton, PA, based on product availability. Our standard methods of shipping are UPS and FedEx Ground. Guaranteed two-day, overnight and Saturday delivery are available for time sensitive orders at an additional fee. US Mail Priority and Parcel Post shipping is also available to some areas.

PAYMENT TERMS: We accept VISA, MasterCard, Discover and American Express with no additional charge for credit card payment. We will also ship C.O.D. certified check with prior approval. Please note, FedEx and UPS do not accept cash C.O.D. payments. The carrier's C.O.D. fee will be added to all C.O.D. orders. Our credit application is located on pages 193 and 194. All portions of the credit application **MUST** be completed and signed. Partially completed credit applications cannot be processed. A credit application is not required for credit card orders. A \$25 fee will be charged for any returned check. Prepaid orders from international customers are welcome. Payment options include wire transfer, money order, secured check and PayPal. Additional fees may apply.

INSURANCE: Orders under \$100 are automatically insured by FedEx or UPS. Orders greater than \$100 will incur an additional insurance fee.

REFUSALS/INCORRECT ADDRESS: Any orders that are refused or are undeliverable will be charged shipping fees to the customer and return shipping fees to Worthington Distribution, plus a restocking fee of 10% of the invoiced amount. FedEx and UPS impose an address correction fee, which Worthington Distribution will bill you for if an incorrect address is given at time of order. This includes, but is not limited to, incorrect street address, missing suite/apartment numbers, or incorrect ZIP code. To avoid both this charge and shipping delays, please confirm accurate shipping information at time of order.

DROP SHIPMENTS: We can ship directly to your job site or client as requested. Please make sure that someone will be available to sign for the package(s) or arrange for a signature release on file with the carrier. Manufacturer special orders, large orders and expedited orders may also be drop shipped directly from the manufacturer to your location. Although Worthington Distribution does not charge for drop shipments, please note that several manufacturers do charge a drop ship fee. You will be billed separately for any incurred drop ship fees and shipping costs.

BILLING/SHIPPING DISCREPANCIES: Shipping or billing discrepancies (misshipped items, missing items, incorrect charges, etc.) must be brought to our attention within **5 days of receipt of package**.

DAMAGED IN SHIPPING: When you receive your merchandise, please open all boxes immediately to check for contents and/or damage. Every effort is made to pack your goods to prevent damage during shipping; however, if damage does occur, you must notify Worthington Distribution within **5 days of receipt of package**. We will file a claim with the carrier, and upon credit from the carrier, we will issue credit to you. FedEx and UPS reserve the right to inspect packaging and damaged products; packaging and product must be made available for inspection at the delivery address. If your package arrives visibly damaged, please ask your courier to make a note of the damage at time of delivery.

DEFECTIVE RETURNS: Although Worthington Distribution understands how exasperating it is to receive a defective product, we must adhere to all **manufacturer warranty requirements**. Therefore, in accordance with the manufacturer's terms and conditions, the manufacturer has the right to repair or replace defective product at their discretion. Some manufacturers will handle these returns directly. Upon manufacturer's approval we will replace defective products returned to us within 30 days of the invoice date. Defective products **must** be returned in the manufacturer's original packing, and the carton **must** include **all** components and other items originally packaged with the product, including all manuals, etc. **Do not write on or use the product box as a shipping box**. You pay shipping to us, and we will pay for domestic return shipping to you via UPS Ground. Many manufacturers reserve the right to return your product to you, should the product prove to be operational; in these cases credit will not be issued for the product, and return shipping fees will be billed to you. Please feel free to contact us for free technical assistance and troubleshooting if you feel you have received a defective item. Please note that some manufacturers require factory troubleshooting prior to RMA issuance.

ALL RETURNS: **There are no returns on special order merchandise.** All return requests must be made within **30 days** from date of purchase. During this 30-day period, all new and unused products that are currently manufactured, in their original packaging with all hardware and manuals, and in resellable condition, can be returned without a restocking fee; **installed items cannot be returned**. You must pay shipping to us. Product not meeting these criteria, in most cases, cannot be returned or is subject to a restocking fee. Due to copyright laws, software, books, and manuals are not returnable. Wire and conduit are also not returnable. Shipping charges are not refundable and returns must be sent to Worthington Distribution freight prepaid. Worthington Distribution is not responsible for returns lost or damaged during shipping. **Our RMA request form must be completed before an RMA number is issued.** To obtain an RMA request form, contact us at 1-800-282-8864, or you can download the RMA form at www.worthdist.com>Returns. RMA numbers are issued to ensure proper credit is applied or replacement product is handled correctly. You must write the RMA number on the outside of the shipping package you are returning, not on the manufacturer's package. RMA numbers are valid for **15 days** from date of issue. Returns without an RMA number on the box are subject to refusal. **Note: It is the customer's responsibility to verify compatibility and customer commitment prior to ordering and installing any items. Store credit must be used within one year from date of return.**

PRICING: Prices in this catalog supersede all previous pricing. Although catalog price is generally held, prices may change due to market fluctuation. This can result in lower pricing to you, our valued customer. Prices and specifications are subject to change without notice. We are happy to provide written quotes for your upcoming jobs. Quotes are valid for 30 days from date of issuance. Please log in to the dealer store at www.worthdist.com for the most current pricing.

DISCLAIMER: Although every effort has been made to ensure the integrity of this publication, occasional omissions, typographical errors or misprints do occur. Worthington Distribution cannot be held responsible for any misrepresentation associated with any product or price in this publication. All trademarks and registered trademarks are the property of their respective companies. No portion of this publication may be reproduced without express written permission from Worthington Group, Ltd.

Placing an order with Worthington Distribution indicates acceptance of these terms and conditions.

DEALER CREDIT APPLICATION

Credit card and Prepaid Orders can be placed without application



Date _____

Expected Monthly Purchases _____

Exact Company Name _____ Phone _____

Street Address _____ Fax # _____

PO Box _____ Email _____

City _____ State _____ ZIP _____

Authorized purchasing agent(s) _____

A/P contact _____ A/P phone _____ A/P fax _____

A/P email _____ Send invoices by: () email () mail Send Statements by: () email () mail

EIN Number _____

Is your company tax exempt? () Yes () No
 (If Yes, a copy of the exemption certificate issued by the Dept of Revenue of the state you will be doing business in MUST be attached to this application or sales tax will be charged.)

Type and nature of business _____ Date established _____

Length of time at this address _____ years _____ months Number of employees _____

Date of business purchase if not original owner _____ (mm/dd/yyyy)

This company is a: () Sole Proprietorship () Partnership () Corporation State of Incorporation _____

Type of corporation: () C () S () LLC (please enclose articles of incorporation if applicable)

Is there a parent corporation? () Y () N () Subsidiary

If yes, Name _____

Street Address _____

City _____ State _____ ZIP _____

If necessary, will this second business guarantee your account? () Yes () No

If necessary, will this second business authorize billing to them? () Yes () No

Are purchase order numbers required on orders? () Yes () No

ANSWER SEPARATELY FOR EACH PRINCIPLE OF COMPANY

	Principle 1	Principle 2
Name	_____	_____
Title	_____	_____
Date of Birth	_____	_____
Social Security Number	_____	_____
Home Address	_____	_____
City, State, ZIP	_____	_____
Own home or rent?	_____	_____
How long at this address?	_____	_____
Marital Status	_____	_____
Spouse's Name	_____	_____
Home Phone	_____	_____
Any other income?	_____	_____

FOR WORTHINGTON DISTRIBUTION USE ONLY	
Date _____	Acct # _____
Credit Terms _____	Credit Line _____
Approved By _____	

BUSINESS REFERENCES THAT EXTEND CREDIT TO YOU:

Please provide complete names and addresses of firms. Do not submit credit card references - they do not confirm. **Fax numbers are required.** If more space is needed, please attach a separate sheet.

	Reference 1		Reference 2
Name	_____	Name	_____
Address	_____	Address	_____
Phone	_____	Phone	_____
Fax #	_____	Fax #	_____
Contact	_____	Contact	_____
Acct #	_____	Acct #	_____
	Reference 3		Personal Reference
Name	_____		_____
Address	_____		_____
Phone	_____		_____
Fax #	_____		_____
Contact	_____		_____
Acct #	_____		_____
			Please provide a non-relative personal reference who does not live with you.

Account Information

	Checking	Savings	Loan
Bank	_____	_____	_____
Address	_____	_____	_____
City, State, ZIP	_____	_____	_____
Acct. #	_____	_____	_____
Phone	_____	_____	_____
Fax #	_____	_____	_____
Authorized Signers	_____	_____	_____

Authorization

In the event that my account goes out of terms, Worthington Distribution has my authorization to apply charges to this account (choose one):

VISA MasterCard Account # _____ Exp. Date _____
 AMEX Discover CVVC # _____ Authorized Signature _____

I certify that the above information is true. I authorize you to contact any source named above to verify any data. Worthington Distribution and its affiliates may investigate my personal credit history, as well as the business credit history. Consumer reports may be requested in processing this application, and in the normal course of business, pursuant to the Fair Credit Reporting Act. I am aware that they will rely on this information in extending credit to me. The above information may be used in collection of any debt. In the event of non-payment, I agree to pay interest, your attorney's fees in the sum of 33% of principal amount due and costs of collection as part of my debt. I further agree that the laws of Pennsylvania shall apply to all issues arising between us. I agree to the exclusive jurisdiction of the courts of the State of Pennsylvania as to all disputes between us. My account privileges may be cancelled or altered by you at any time.

Signature _____ Print Title/Position Held _____
 Print Full Name _____ Date _____

I hereby personally and unconditionally guarantee the payment of any and all amounts due from this applicant to Worthington Distribution and/or its affiliates. No modification of extension of credit to applicant shall affect my guarantee, and I waive any notice of any such change in credit terms and of any default. I agree to all of the above terms and conditions agreed to by the applicant as part of my guarantee and incorporate them herein.

Signature _____ Date _____
 Print Full Name _____

**Please allow 4 to 6 weeks for processing. Incomplete information will delay your application.
 A charge of 1.5% (min. \$5.00) will be assessed on all overdue accounts.**

WORTHINGTON
DISTRIBUTION

Wakes with a touch!



Yale®

Yale
real Living™

Z-Wave® Door Locks

Designed from the ground up with security in mind

NEW



Introducing the
key free deadbolt!

The only Z-Wave® capacitive
touchscreen available

Compatible with all Z-Wave systems
to lock/unlock remotely



Protects the door with rubber gasket installation

Standard phone layout – *no shared buttons!*

Manage up to to 250 codes

Truly customizable features:
privacy, auto re-lock, and voice
on touchscreen models

www.yalerealliving.com



Tellis 4-RTS Pure

**Expand Your Offering with
Motorized Shades!**



Motorized window coverings offer users total management over a critical element of every home – natural light.

With Home Motion by Somfy, you can provide your customers the promise of a home that comes alive every day, increasing comfort, convenience and energy efficiency.

Motorized blinds, shades, draperies and awnings powered by Somfy can be installed as standalone systems or easily integrated into third party automation systems using Z-Wave®, ZigBee®, RS485, RS232, and more.

Somfy provides power options to suit every jobsite including low voltage, line voltage, battery, and even a rechargeable solar kit. No matter the application, there is a Somfy-powered solution.

IP Networking Just Got Less Complicated!

Luxul Xen™



Wireless Access Points



Multi-WAN Routers



Gigabit and POE Switches



Introducing Luxul XenMaster™

The Luxul XenMaster™ Smartphone application further simplifies and optimizes the Luxul Xen™ network setup process using virtually any mobile device. Luxul XenMaster is designed to take the guess work out of the installation process by walking the installer through basic setup features.



The Luxul Xen Experience:

- ▶ Affordable enterprise class features and performance
- ▶ Simple installation with XenConnect™
- ▶ Eliminate roaming Wi-Fi client handoff issues
- ▶ One source for the entire network
- ▶ Available only to professional installers through CEDIA channels

LUXUL

Simply Connected

luxul.com

Smart Solutions for the Next 100 Years

After a century of industry leadership our focus today is on sustainability, functionality and intelligent design. From Smart sensors for green buildings, to smart submetering. From electric vehicle charging to the world's leading GFCI line, Leviton means quality and innovation, yesterday, today and tomorrow.

Learn more at leviton.com



Centralite® Lighting Control Systems Have the **FASTEST** Programming Available!

And FASTER is ALWAYS better.

In today's economy, customer's do not want to pay an arm and a leg to control their lights. I've been installing Centralite for years and Elegance and Jetstream are reliable and easy to program. It gives me a clear competitive advantage against my competition.

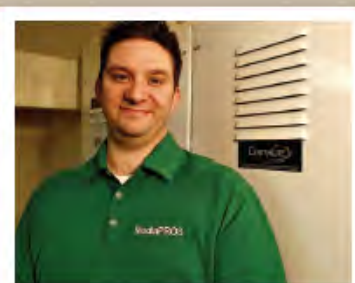

Chris Langhorst
MediaPROS
Las Vegas, NV

Elegance XL

- Up to **768** Loads
- Choice of 1-8 button keypads
- Fan Speed Control
- Low and High Voltage Relays
- Astronomical Clock

JetStream RF

- Up to **200** Loads
- Zigbee Protocol
- 800/1000 Watt Rating
- Car Visor Remote
- Any button can control any load or scene
- No repeaters or base station!



877.466.5483 or www.centralite.com

©2010 Centralite Systems, Inc. All rights reserved.

CENTRALITE®

LIGHTING CONTROL SOLUTIONS

 EverFocus[®]

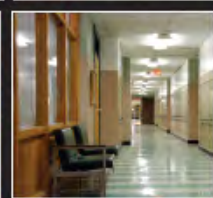

IP, HDcctv, Analog, Access Control, Mobile, Apps & Software

**FREE &
Easy**
IP Pre-Config
We set it up for you!



 EverFocus[®]

CA: 626-844-8888 | NY: 631-436-5070 | sales@everfocus.com | www.everfocus.com

EverFocus will help plan and design your system.

Need Money Now? Capital is Our Middle Name.

Whether your business needs a capital boost, or you're looking for your next challenge, turn to a company that can meet your needs.

Bulk Acquisitions

If you need a quick influx of cash, ACA will purchase a portion or all of your account base. You can continue to generate revenue by:

- Continuing to provide service on accounts acquired by ACA
- Installing additional equipment on accounts acquired by ACA
- Continued leads and referrals
- Selling accounts through ACA's Independent Dealer Program

We have completed over 600 acquisitions and have a proven track record of making your short term and long term goals truly attainable.

Start the conversation today
888-885-8656

Independent Dealer Program

ACA's Independent Dealer Program meets the needs of select companies across the US who choose to market their business in their own name and keep an on-going relationship with the customers they sell.

- Highly competitive multiples
- Weekly funding and no minimum sales
- Choose your own equipment and take advantage of special dealer pricing
- Continued revenue from service, equipment add-ons, leads and referrals



**ALARM
CAPITAL
ALLIANCE**

www.alarmcapital.com

LAUNCHPORT

Hold. Charge. Protect.



WallStation

• Inductive charging and magnetic wall mount for Sleeve

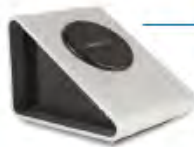

BaseStation

• Inductive charging and magnetic table mount for Sleeve

COMING SOON
For iPad mini & iPad 4th generation*

Sleeves

• For iPad® (4th generation*), (3rd generation) iPad 2 and iPad mini*
• Available in Black or White
* Shipping in June



LaunchPort.com

by iPort

Inductive Charger Magnetic Mount



on a wall
WallStation



SONARRAY

BY SONANCE

*The perfect step up
from rock & outdoor
cabinet speakers!*

SONARRAY SR1 SYSTEM

- 8 Satellite Speakers + 1 In-Ground Subwoofer
- 8 Ohm impedance matched system
- Perfectly even coverage up to 2,000 square feet*

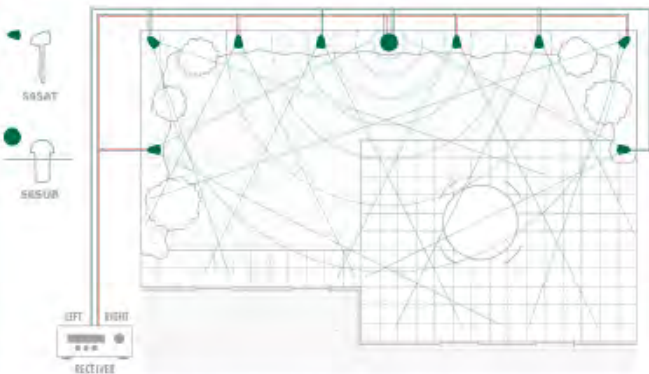

The SONARRAY SR1 SYSTEM raises the bar on outdoor entertainment; featuring eight 3.5" satellite speakers that are evenly distributed in an array across the perimeter of the backyard, along with an 8" dual voice coil in-ground subwoofer with a canopy that is hidden under foliage. The result is incredible sonic performance and even SPL throughout the space, eliminating dead zones and hot spots as well as reducing any disturbance to your neighbors All while remaining out of site.



SONARRAY | 212 Avenida Fabricante | San Clemente, CA 92672 USA | (800) 582-7777 | www.sonarray.com

SONARRAY and Sonance are trademarks of Dana Innovations, registered in the U.S. and other countries. Copyright 2013, all rights reserved. Patent pending.

* Depending on property layout.

JOIN CEA

Join CEA's TechHome Division and Receive a \$50 Credit to Worthington Distribution!*

The TechHome Division has been a thriving member group within the Consumer Electronics Association (CEA)[®] for more than 10 years and is unique in that it represents the entire channel for home technology, including integrators, custom installers, retailers, distributors and manufacturers. Any CEA member with an interest in the home technology channel may participate. The TechHome Division's mission is to increase the sales and support of professionally installed home technology products.

Areas of focus for the TechHome Division include:

- Business Development
- Builder and Realtor Outreach and Awareness
- Consumer Education
- TechHome Installer Locator Tool
- TechHome Rating System
- Market/Consumer Research
- Energy Efficiency Issues
- Technology Standards for Design and Installation of Residential Systems

Interested in the categories above or have an additional area of focus you'd like to discuss with the TechHome Division? Contact Kinsey Fabrizio at kfabrizio@CE.org or 703-907-4341.

Join CEA today and save \$50 on your next Worthington order:*

VISIT CE.org/Membership. Complete the online membership application and enter priority code **WD13**

OR

CALL: 703-907-7694
EMAIL: membership@CE.org

*This offer is open to new CEA members only that join by June 30.



*You've secured the inside of your home,
but what about the outside?*



- Solar Powered
Wireless Break Beams
- Motion Detectors
- Vehicle Sensors
- DVR Cameras
- Easy DIY installation
- Wireless ranges
up to several miles

Dakota Alert is a leading manufacturer of wireless alert products. Whether you're trying to keep an eye on outbuildings or just want to know if someone is coming up your driveway, our wireless alerts and accessories allow you to be completely aware of any presence on your property.



*Dakota Alert has sensors for your
backyard, driveway, porch, outbuildings and more...*

Security products for your peace of mind.

DA **Dakota Alert, Inc.**
WIRELESS SECURITY EQUIPMENT

Visit www.DakotaAlert.com
for more information.

PO Box 130 | 32556 East Main Street | Elk Point, SD 57025 | PH: 605.356.2772 | FAX: 605.356.3662

DSC

A Tyco International Company

HSPA Universal Wireless Commercial Fire Alarm Communicator **3G3070CF**



Features That Make a Difference:

- Uses HSPA (3G) network for high-speed, reliable and low-cost communications to an IP receiver
- Automatically switches to 2G (EDGE/GPRS) if 3G service is not available
- Compatible with control panels that communicate using the Contact ID format
- Full event reporting
- 4 on-board inputs
- 4 on-board outputs (open collector)
- SIM card (included)
- Activation and initialization via automated telephone activation system (VRU), web-user or mobile interface provided by C24 Communications
- PTM (Panel Transmission Monitor) switches from PSTN to cellular on unsuccessful communication attempts
- Compatible with Sur-Gard[®] System I/II/III/IV monitoring station receivers
- Includes UL listed power supply, transformer and 7 Ah rechargeable battery
- UL 864 listed
- CSFM listed

3G technology from DSC!

The 3G3070CF connects the alarm control panel to the HSPA network and reports alarm signals directly to a monitoring station receiver (Sur-Gard System I/II/III/IV). The 3G3070CF uses the HSPA network to ensure low-cost, high-speed and reliable alarm communications and is compatible with control panels that communicate using the Contact ID format.

The 3G3070CF is compliant with the latest requirements for Communications Methods as per UL864 and NFPA72 2010 Edition. It can be used in Fire Monitoring applications as a single communications technology, in which case any failure of the communications path shall be annunciated at the supervising station within 5 minutes of the failure, or it can be used as part of a multiple communications technologies (for example in conjunction with a DACT). When used as a back-up provision shall be made to monitor the integrity of each communication path and failure of any communications

path shall be annunciated at the supervising station and at the protected premises within not more than 24 hours of the failure.

How it Works

The 3G3070CF can be used as either a Sole Communicator or as a Backup Communicator. When being used as a Sole Communicator the 3G3070CF will replace the phone line connection on the panel and as soon as it detects that an alarm needs to be transmitted it will send the alarm across the HSPA network immediately. When being used as a backup the communicator assesses the connection to the PSTN phone line, and only in the event of a phone line failure will it send all alarm traffic across the HSPA network to the monitoring station.

In instances where the control panel does not support Contact ID, the 3G3070CF has inputs pre-set to transmit fire alarm, fire supervisory or system trouble.

communications

Contact your DSC distributor.
www.dsc.com | 1-888-888-7838

Self Contained Receptacles

Use in Cabinets, Floors, Windows & Mantels

Sillites®

U.S. Patent #6601977

Direct Plug-in Window Candles

No visible wires... they're all in the walls.



Smallest Receptacle Available No J-Box Needed!!



Baseboards



Cabinets



Islands



Mantels



Before - ugly wires



After - wires in wall



For New or Existing Homes!!



2-1/8"

2"

1-3/4"

- For use with one or two 12/2 or 14/2 wire sections
- Tamper resistant
- Rated for 125 volt 15 amp operation
- Meets UL 498 and UL 514C with Floor Ring added
- Can be wired to GFI or arc fault breaker or receptacle

Sillites®

U.S. Patent #6601977

805 S. Glynn St.
Suite 127-345
Fayetteville, GA 30214
Ph. 770-755-5654
Fax 678-868-2440
www.Sillites.com

THE LOCK. LOADED.



The New Touchscreen Deadbolt.

With features like built-in alarm, keyless entry and Nexia™ Home Intelligence compatibility. What's on your doors is now as advanced as what's inside them.

Learn more at schlage.com



NEW FROM SPECOTECH TECHNOLOGIES

THE HIGHEST RESOLUTION DVR



Provides a 30% INCREASE IN RESOLUTION, a step above D1



SEE THE DIFFERENCE NOW!
Check out www.specotech.com/ds-dvr.html

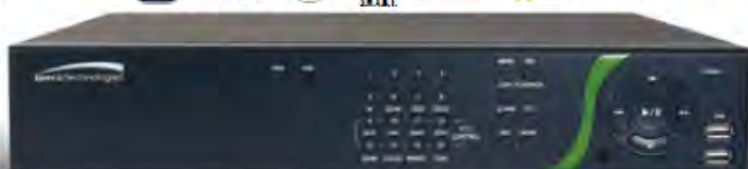

D16D5

INTENSIFIER™
960H Cameras AVAILABLE



HT7246H
2.8-12mm auto iris varifocal lens



HTINTB8H
2.8-12mm auto iris varifocal lens



HTINTD8H
2.8-12mm auto iris varifocal lens

- Real-time 30FPS 960H recording
- Self networking with EZSetup Wizards for quick system setup
- Wireless configuration
- Digital Deterrent™
- Supports USB WiFi access point for remote viewing and configuration
- EZSearch for quick search of events using thumbnails
- HDMI output
- 16 audio inputs
- Up to 9TB of HDD storage
- No networking challenges

Wireless Access Point

- Point-to-point connection to the DVR from your mobile or network device
- Used for remotely viewing and configuring the DVR where physical access to the DVR is limited or restricted

960H What is 960H?

960H is the highest resolution available for analog CCTV and provides a 30% increase in resolution in comparison to D1. The greater the resolution, the higher the definition of the video image. 960H enables the CCTV camera to obtain high resolutions of up to 700 TVL. A 960H DVR must complement the 960H camera to capture this high resolution video.

Advantages of 960H

- Use existing coaxial infrastructure
- 960H cameras can be used with non-960H DVRs
- 960H DVRs can be used with non-960H cameras
- 960H CCD sensor performs better in low-light than IP and HD-SDI CMOS sensors



GO BEYOND CAPTURE, RECORD & REVIEW



Get More Info

Stop crime before it happens

Speco Technologies new line of Digital Deterrent™ Video Surveillance solutions has been exclusively created by Speco Technologies to prevent crime, not just record it. Digital Deterrent™ solutions include PIR cameras, DVRs and 2-way audio communication.



speco technologies

email: sales@specotech.com • ph: 1.800.645.5516 • specotech.com



make all your streams come true

The Russound **Digital Media Streamer**

More features, easier to install. Simply streamy.



3 simultaneous streams | multiple USB ports | SiriusXM enabled
iPad & iPhone controllable | C-Series integration

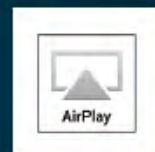

WORTHINGTON DISTRIBUTION

566 Rt 390 • TAFTON, PA 18464

BOUND PRINTED
MATTER
U.S. POSTAGE
PAID
RIPON, WI
PERMIT NO 100



THE BEST OF SYSTEM
INTEGRATION FROM A SINGLE SOURCE

SUPPORT

- Our Technical Sales staff has hands-on and field experience
- We provide unparalleled pre-sales design assistance and technical support after the sale
- We use the experience we have gained with thousands of dealers nationally to help each dealer individually
- Our Technical Sales staff has access to a lab with many of the products you use every day



CALL 800-282-8864 TO PLACE AN ORDER OR VISIT OUR WEBSITE: WWW.WORHDIST.COM

WORTHINGTON UNIVERSITY



TRAINING

- Hands-on classroom remodeled with the latest products and systems
- Class led by industry veterans with years of experience
- 9 workstations fitted with full automation systems provide hands-on experience
- Extensive training on lighting systems using the latest communication technologies
- Free on-demand web based training
- Free monthly webinars

FOR MORE INFORMATION VISIT: WWW.WORTHINGTONU.COM